

145

700-13 45

700-13  
ACT (II)  
FADE IN

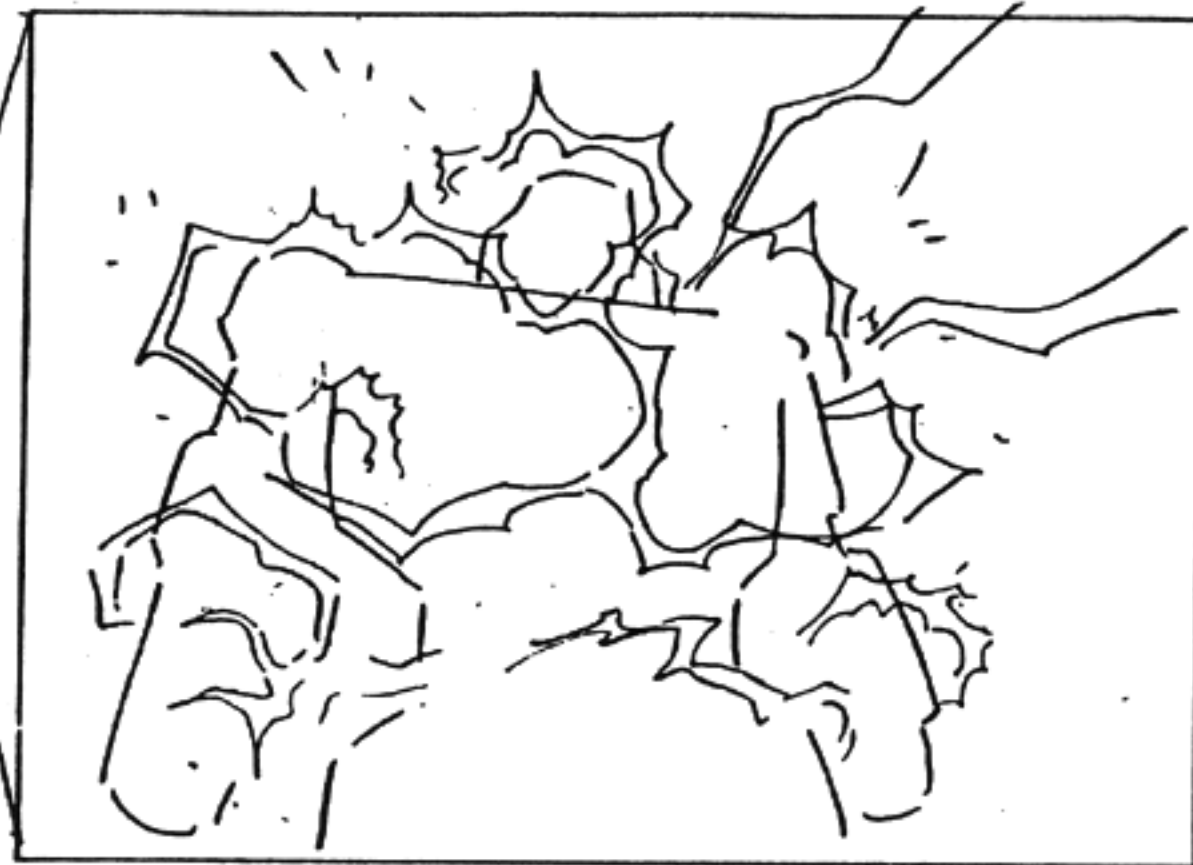

M.S. MEGATRON: AS HE SPEAKS HIS BODY CRACKLES WITH ENERGY...  
MEGATRON: I NOW HAVE THE STRENGTH OF ALL MY DECEPTICONS!

CONT.

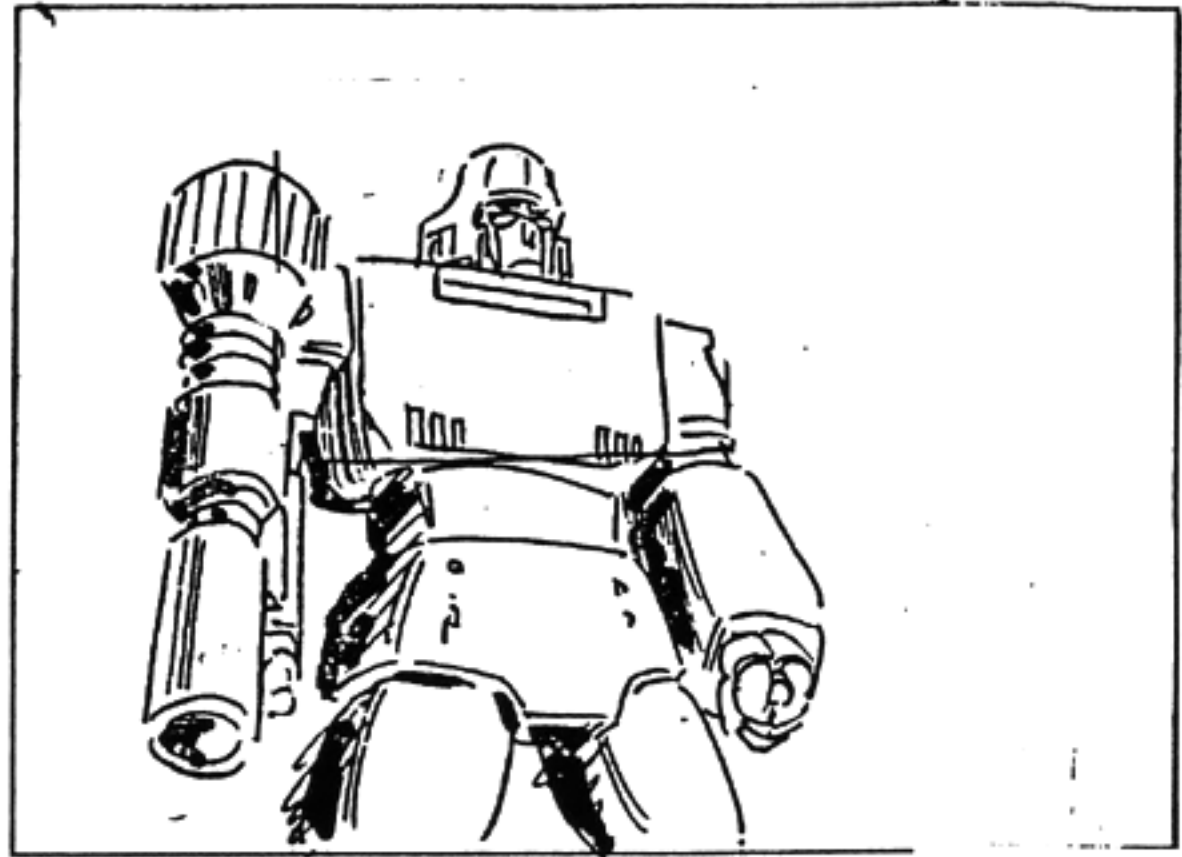

... WHICH QUICKLY FADES AND HE LOOKS NORMAL.  
MEGATRON (CONT)... THE UNSUSPECTING OPTIMUS PRIME IS AS GOOD AS BEATEN! (LAUGHS)

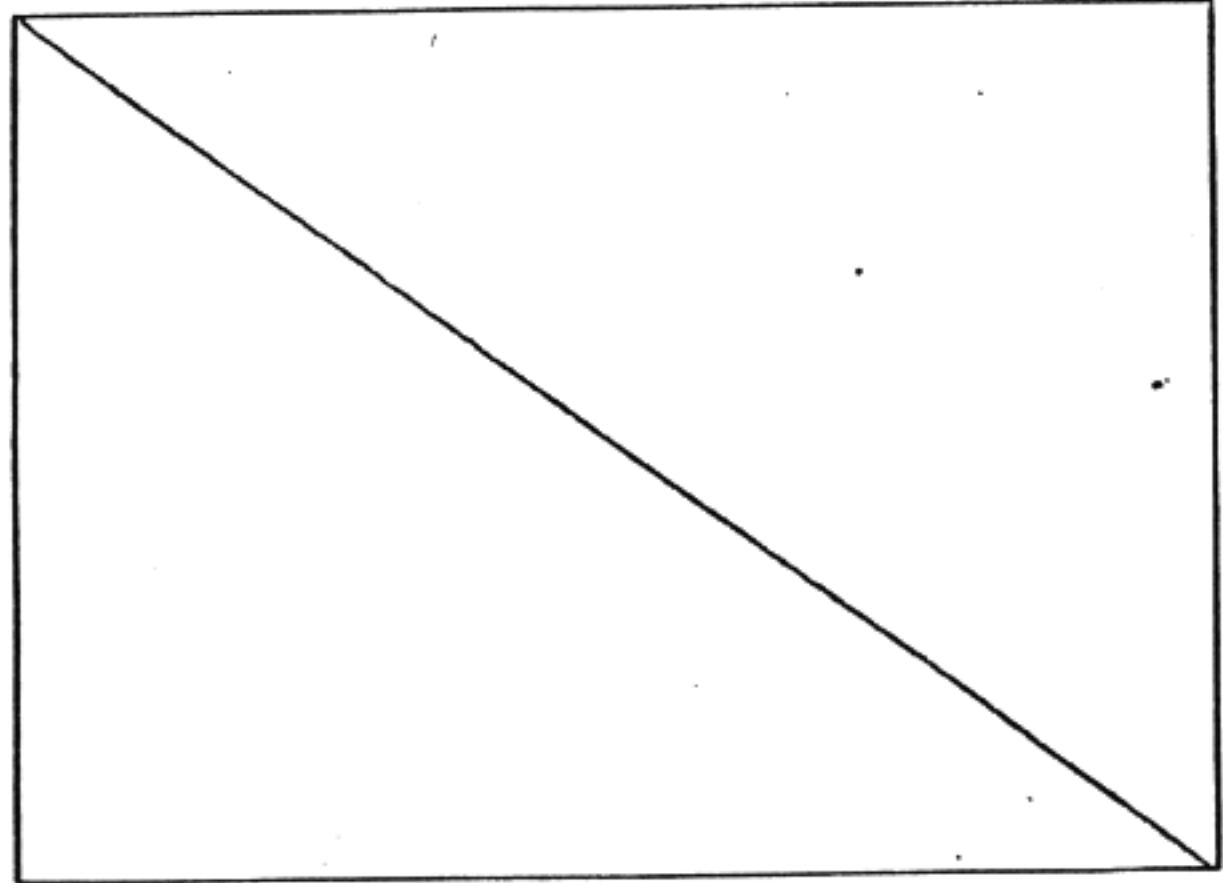

146

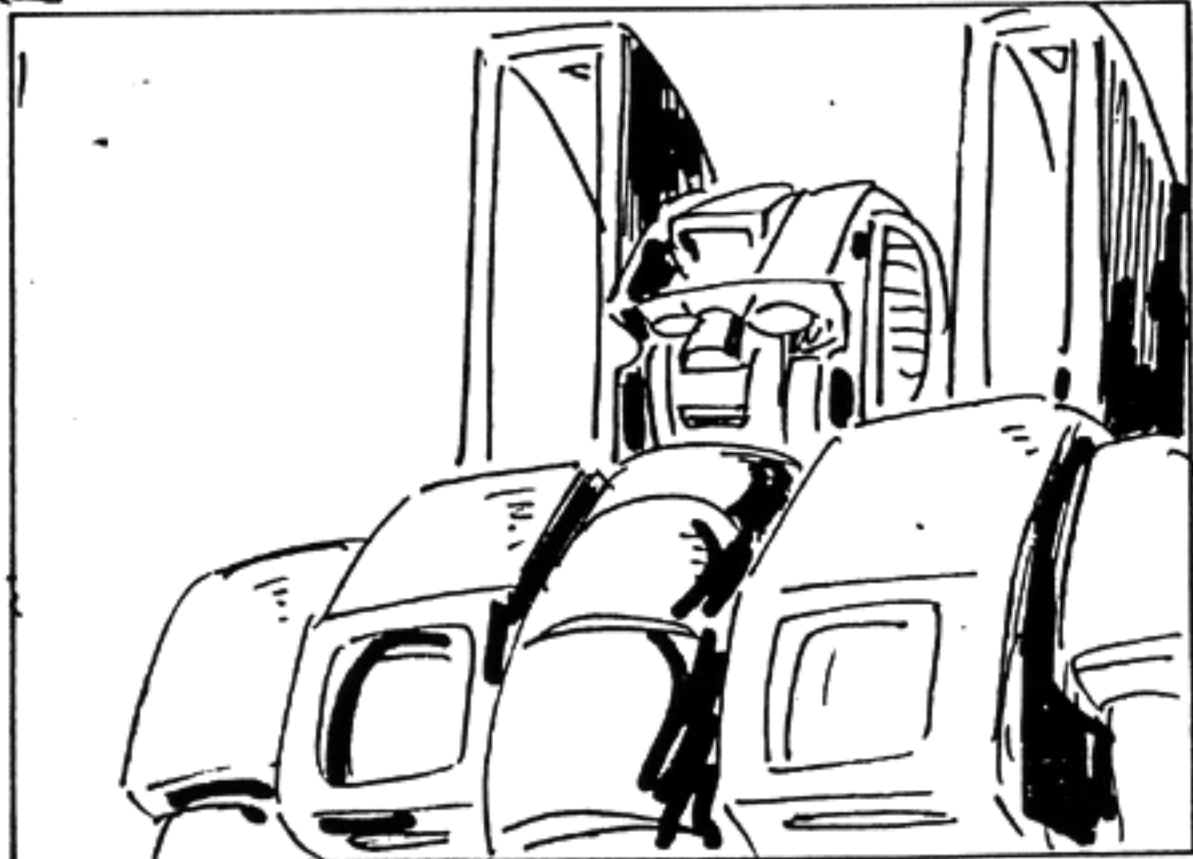

M.C.U. STARScream  
STARScream: WITH ALL DUE RESPECT, MEGATRON-- I SUGGEST YOU NOT CELEBRATE YOUR VICTORY PREMATURELY...

147

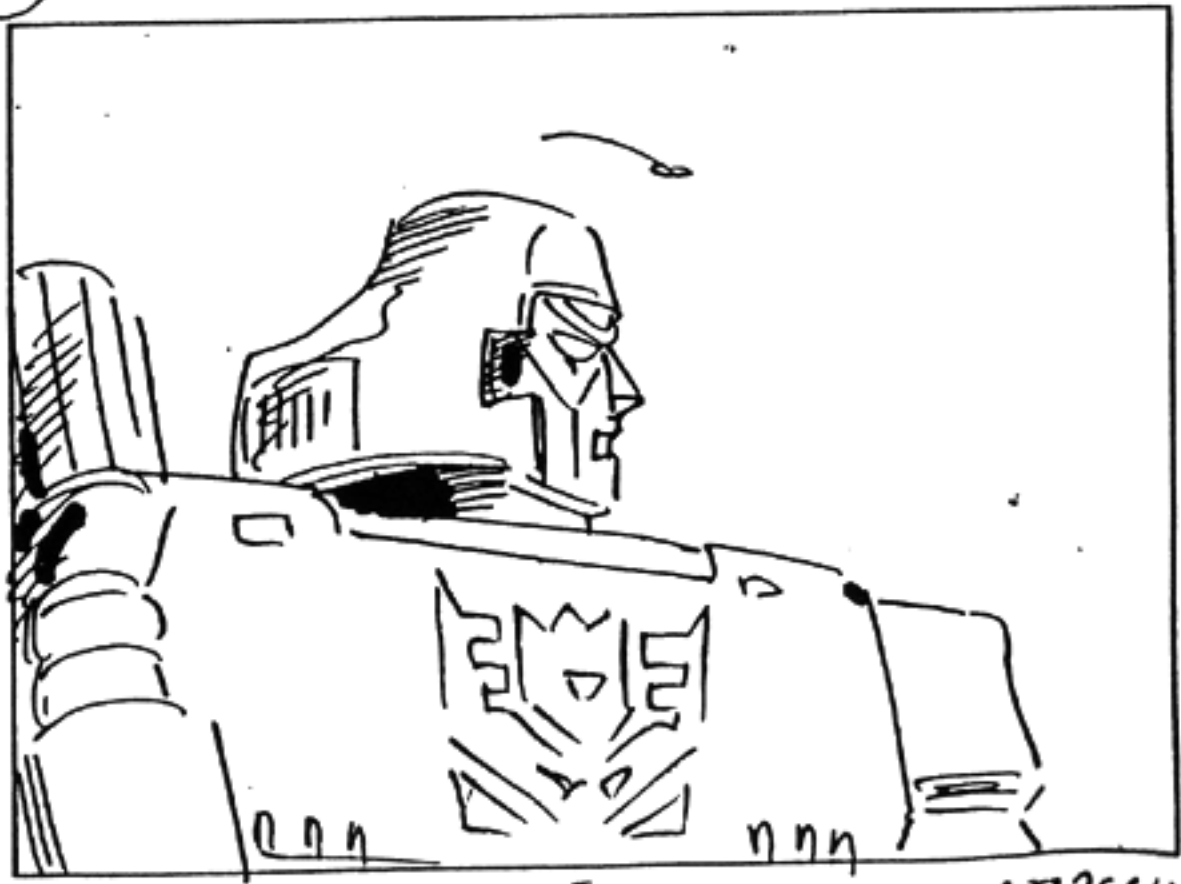

M.C.U. MEGATRON, HE TURNS TOWARD STARScream.  
STARScream (VO)... AS THERE MIGHT BE ONE FLAW IN YOUR OTHERWISE FLAWLESS PLAN.

148

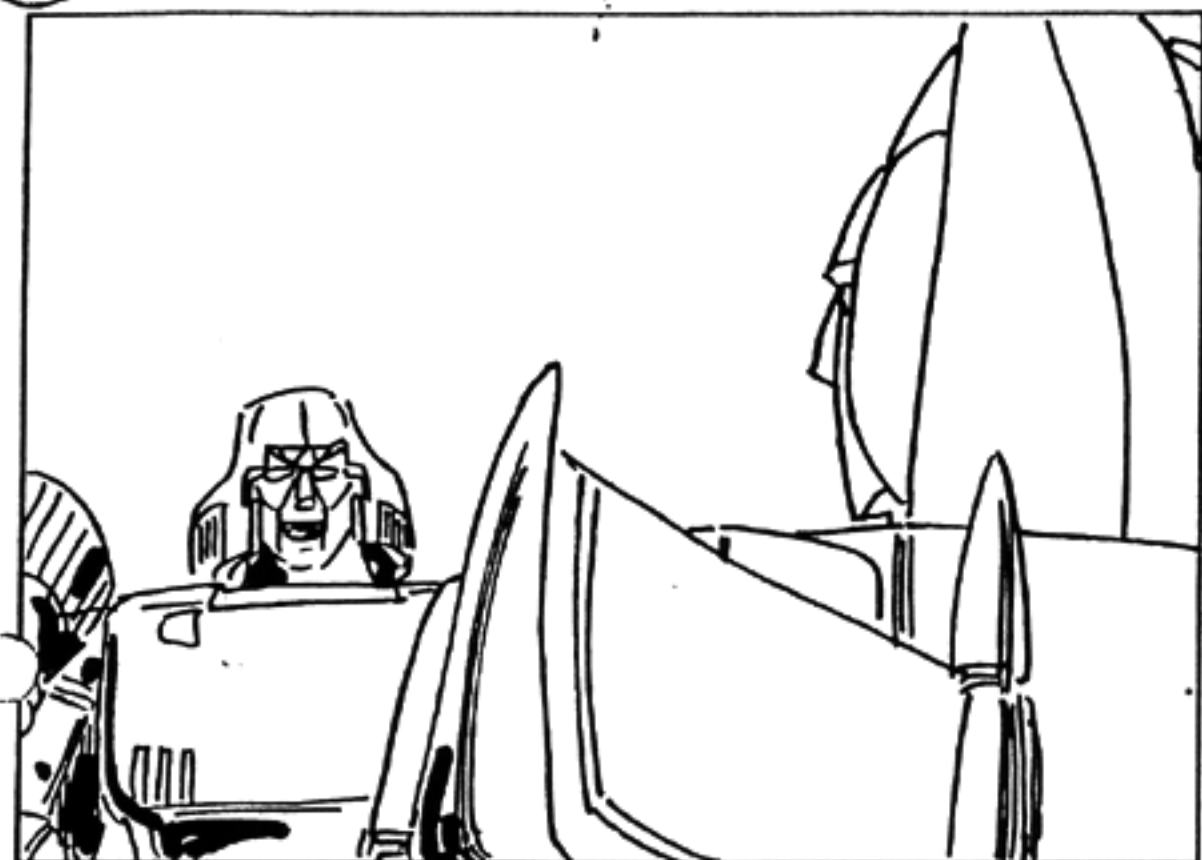

2 SHOT STARScream & MEGATRON.  
MEGATRON: AND WHAT MIGHT THAT BE,  
'LOYAL' STARScream?

CONT.

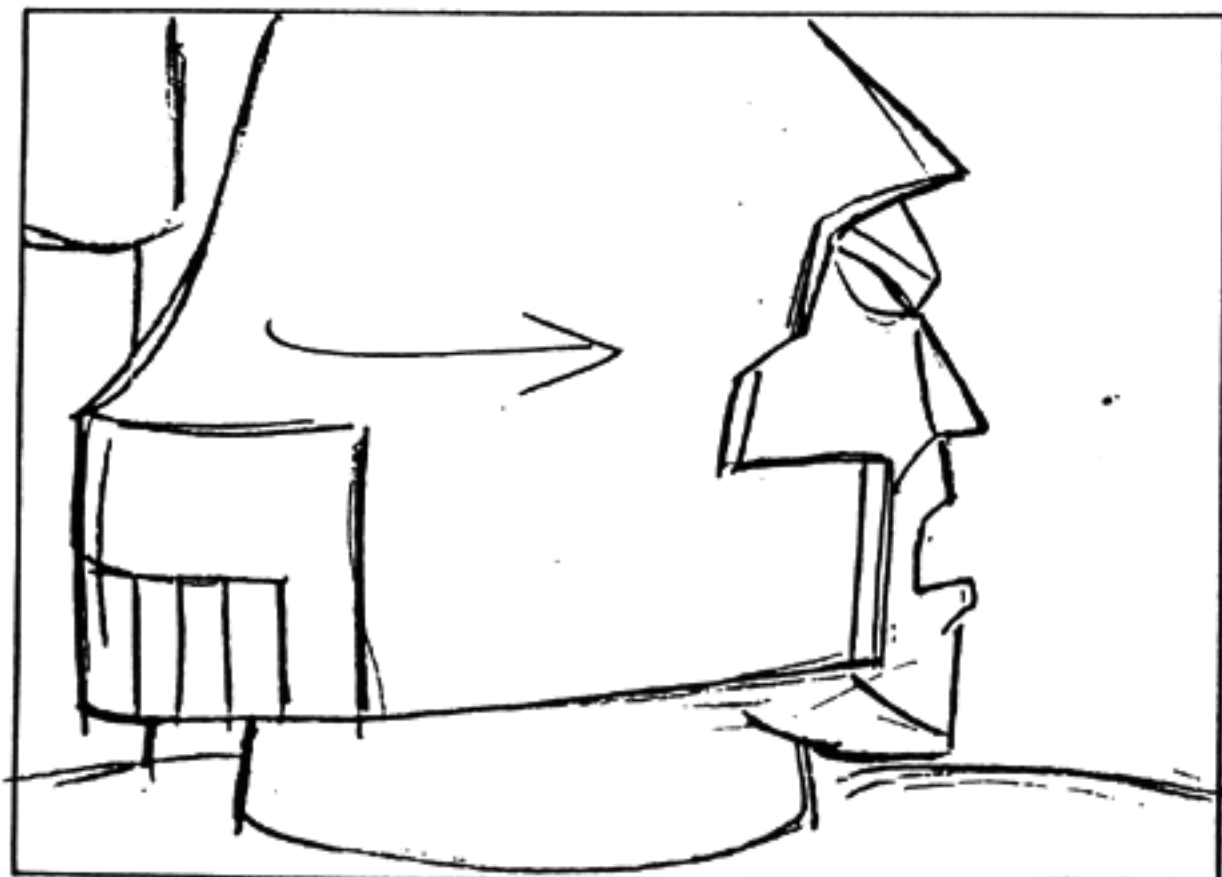

MEGATRON (CONT) SCRAPPER!

149

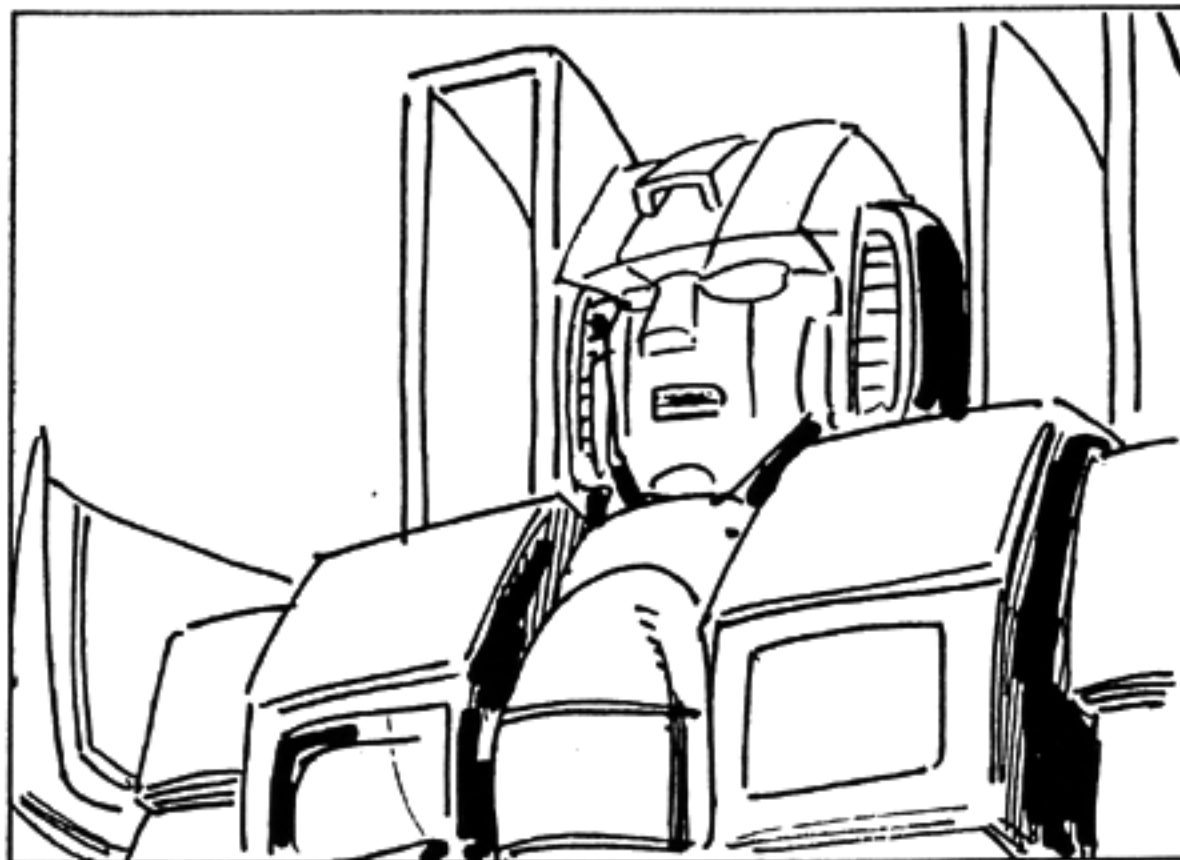

M.C.U. STARScream  
STARScream: THE AUTOBOTS' COMPUTER,  
TELETRANI. IF IT DETECTS YOUR DECEPTION,  
IT WILL ALERT OPTIMUS PRIME.  
MEGATRON (V.O.) IT WON'T!

150

700-13



C.U. MEGATRON!  
MEGATRON: TELETRANI HAS ALREADY  
BEEN ACCOUNTED FOR IN MY MASTER PLAN.

151

STOP

← PAN

START

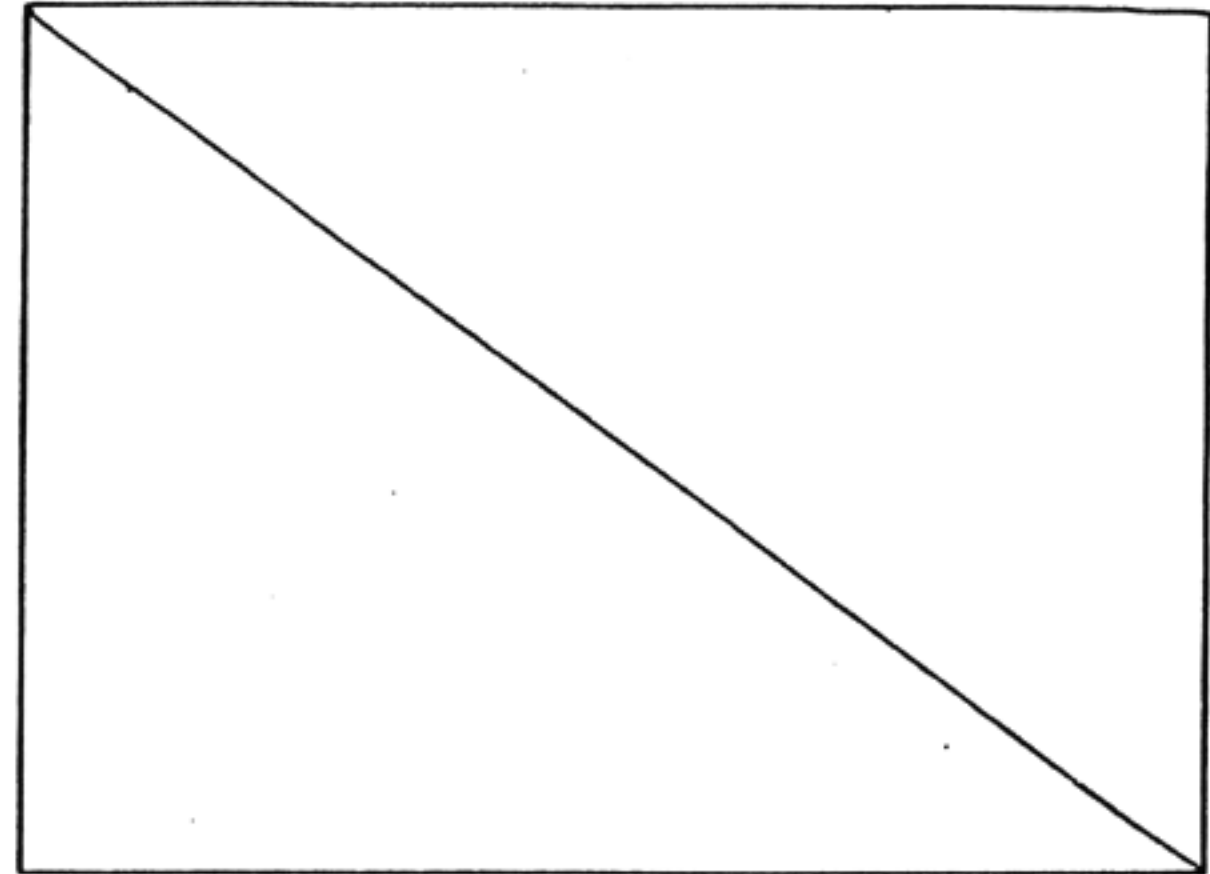
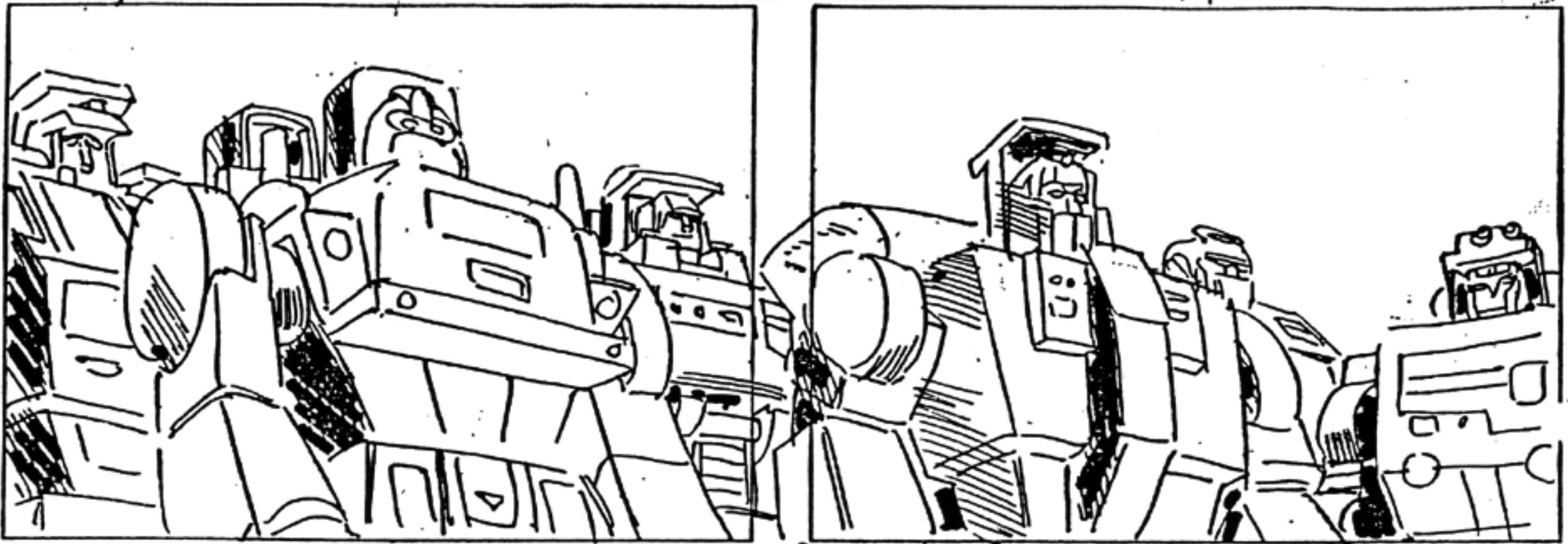

M.S. SCRAPPY AND THE OTHER CONSTRUCTION  
 MEGATRON (VO/CONT) ... YOU AND THE OTHERS HAVE YOUR ORDERS.  
CONSTRUCTION -- TRANSFORM!

152

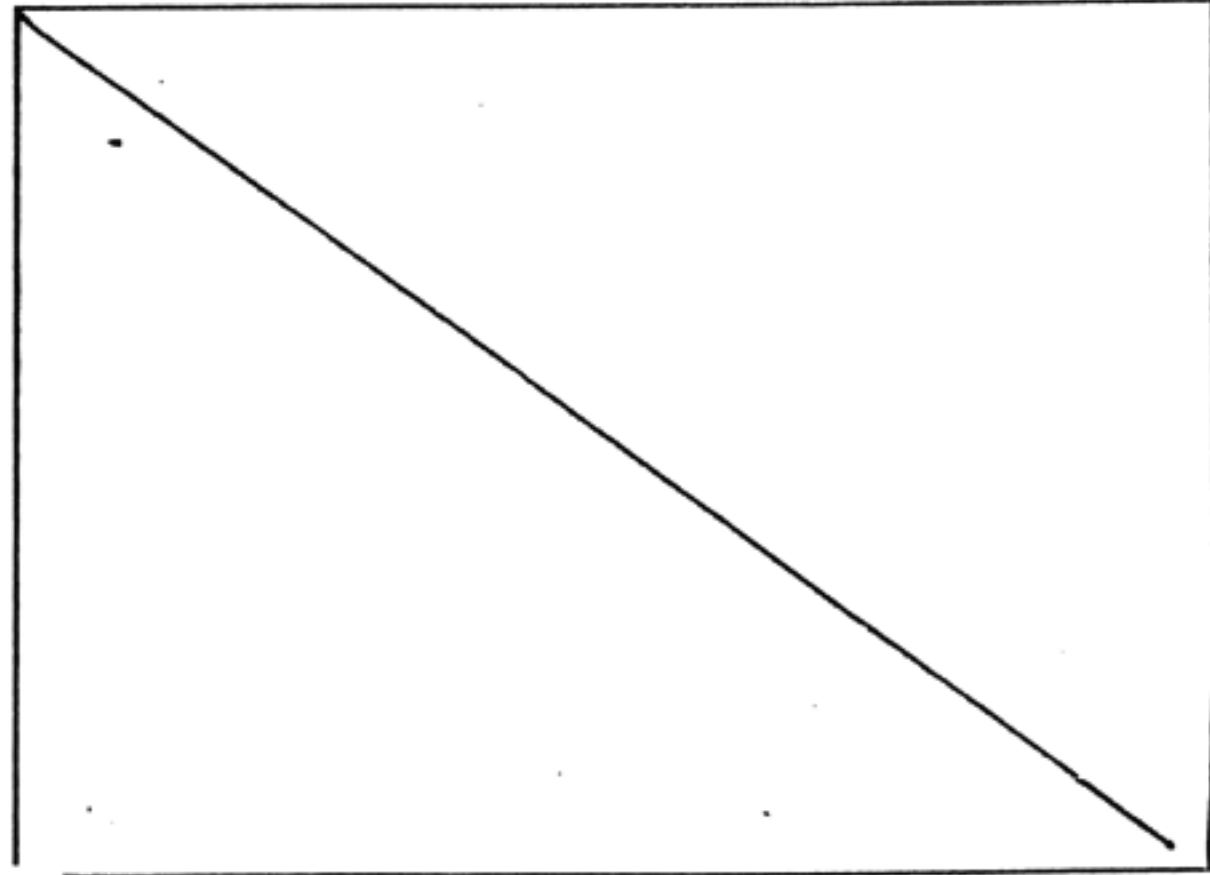
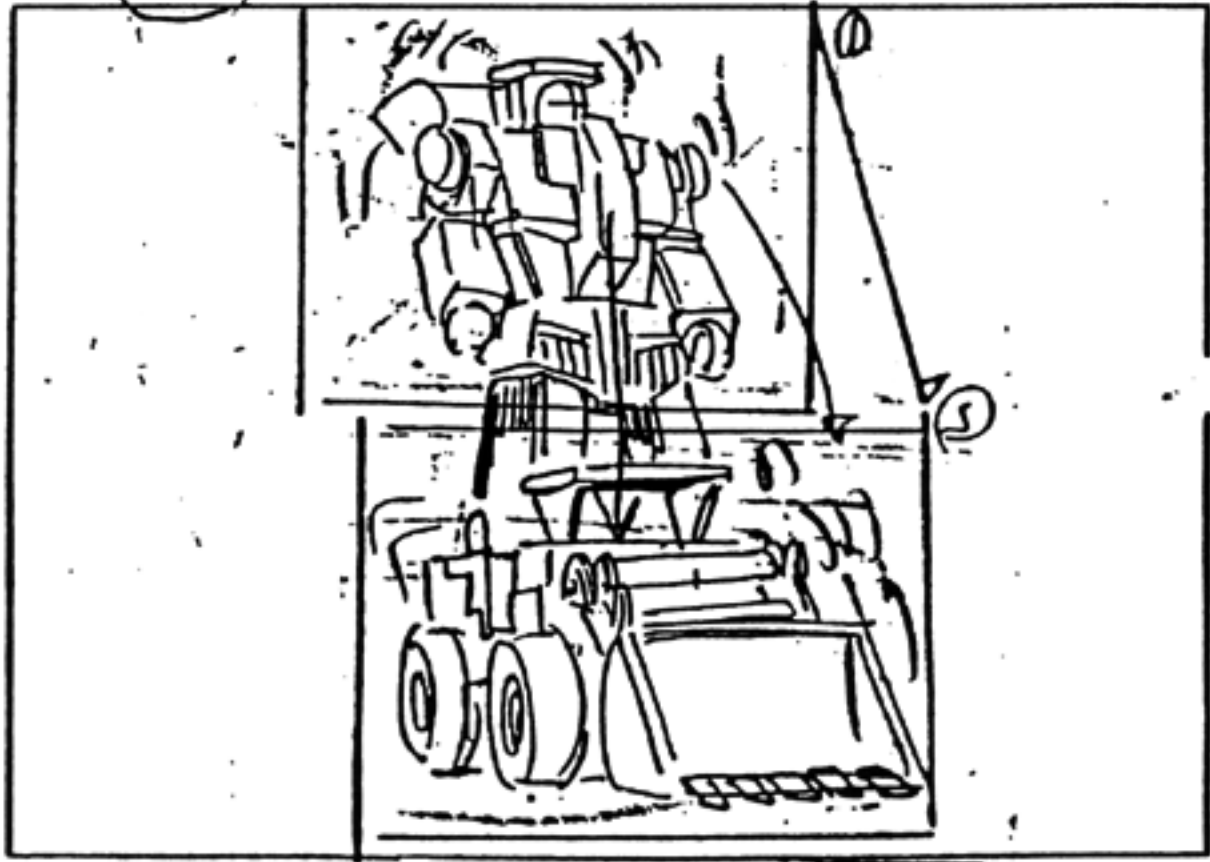

M.S. SCRAPPY TRANSFORMS

153



M.L.S. SCAVANGER, MIXMASTER, & LONG HAUL  
 TRANSFORM

154

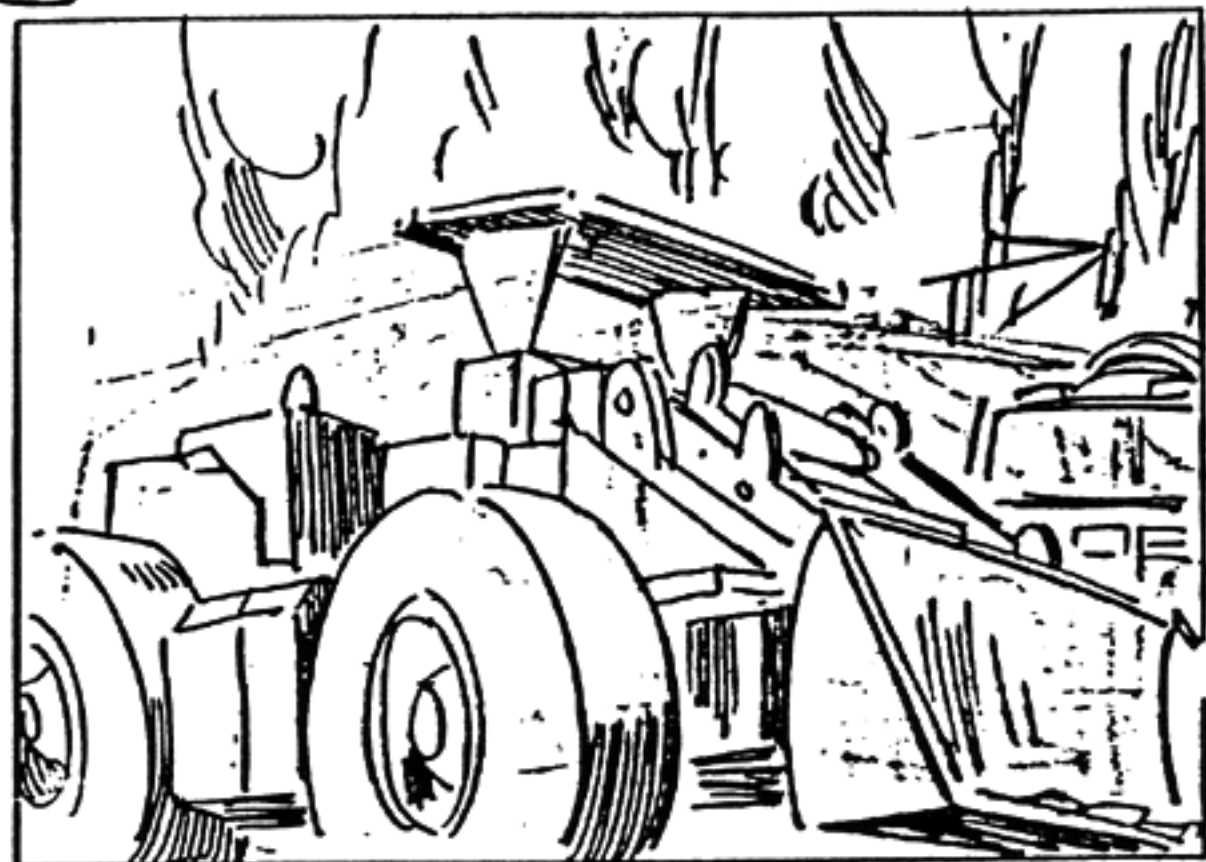

MS SCRAPPER ROLLS PAST...

CONT.

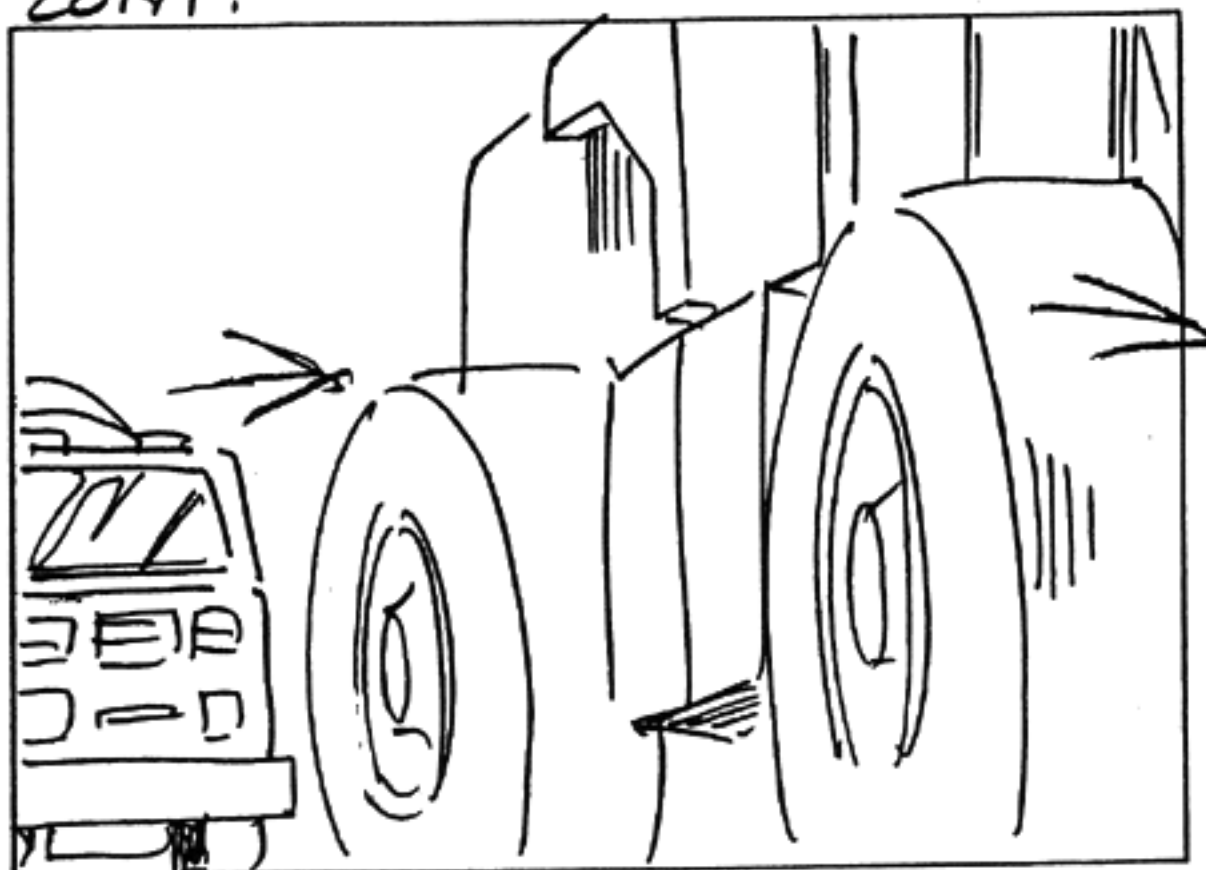

FOLLOWED BY MIXMASTER WHO IS ...

CONT.

700-13

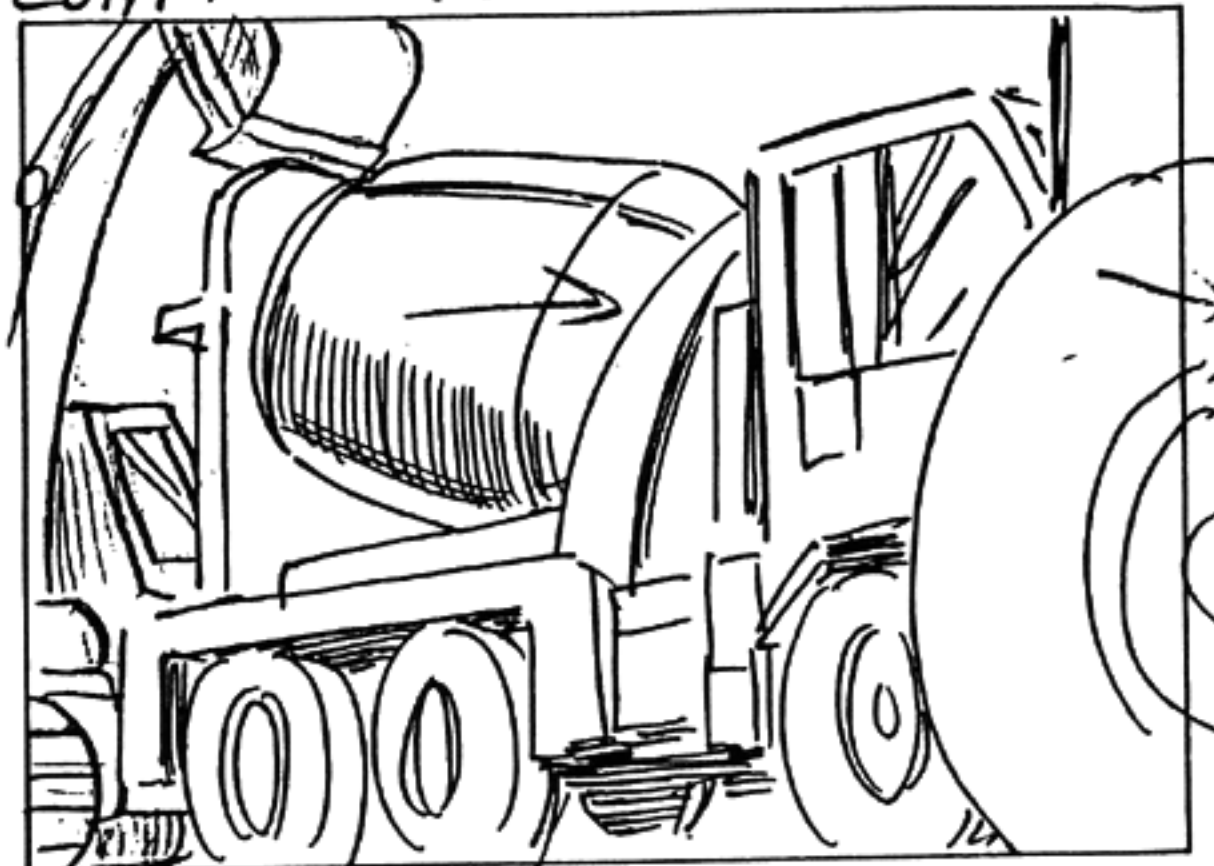

FOLLOWED BY SCAVANGER,

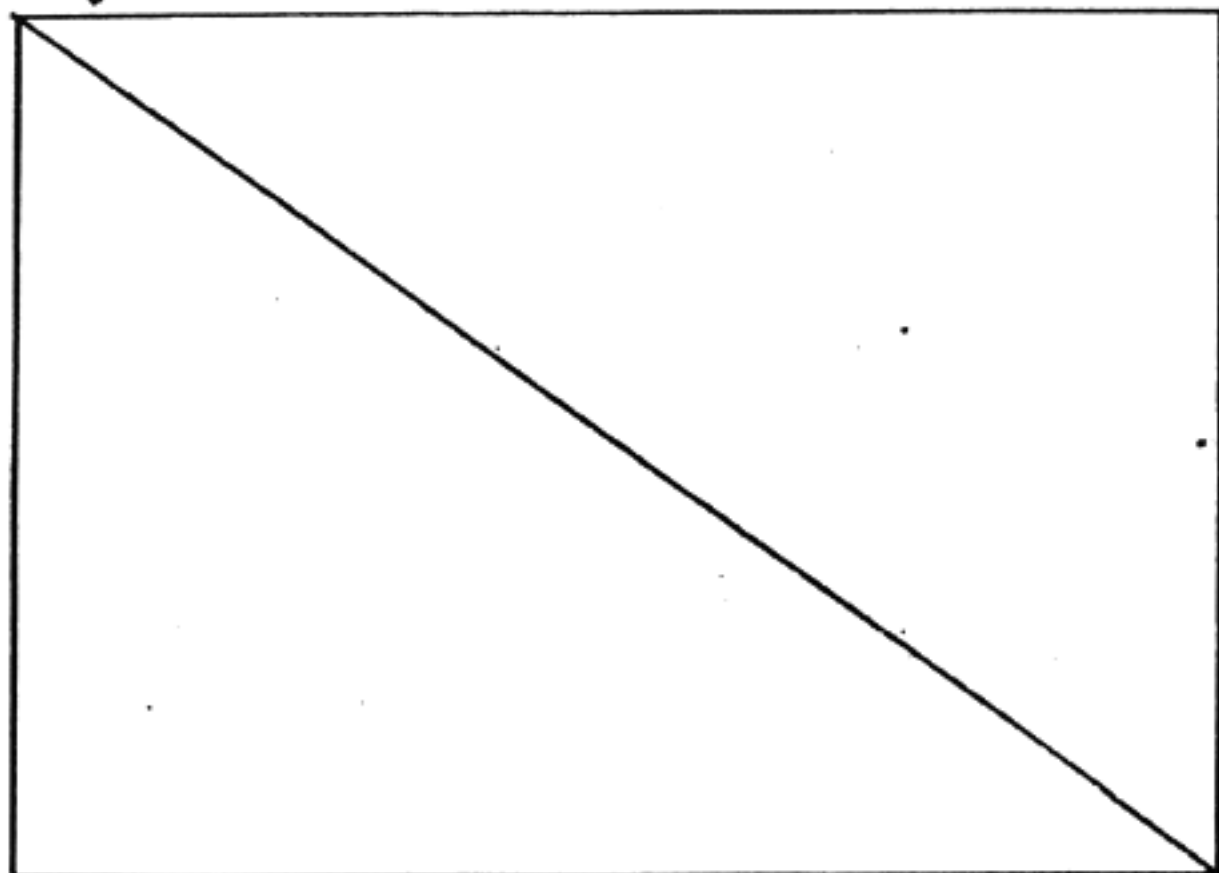

155

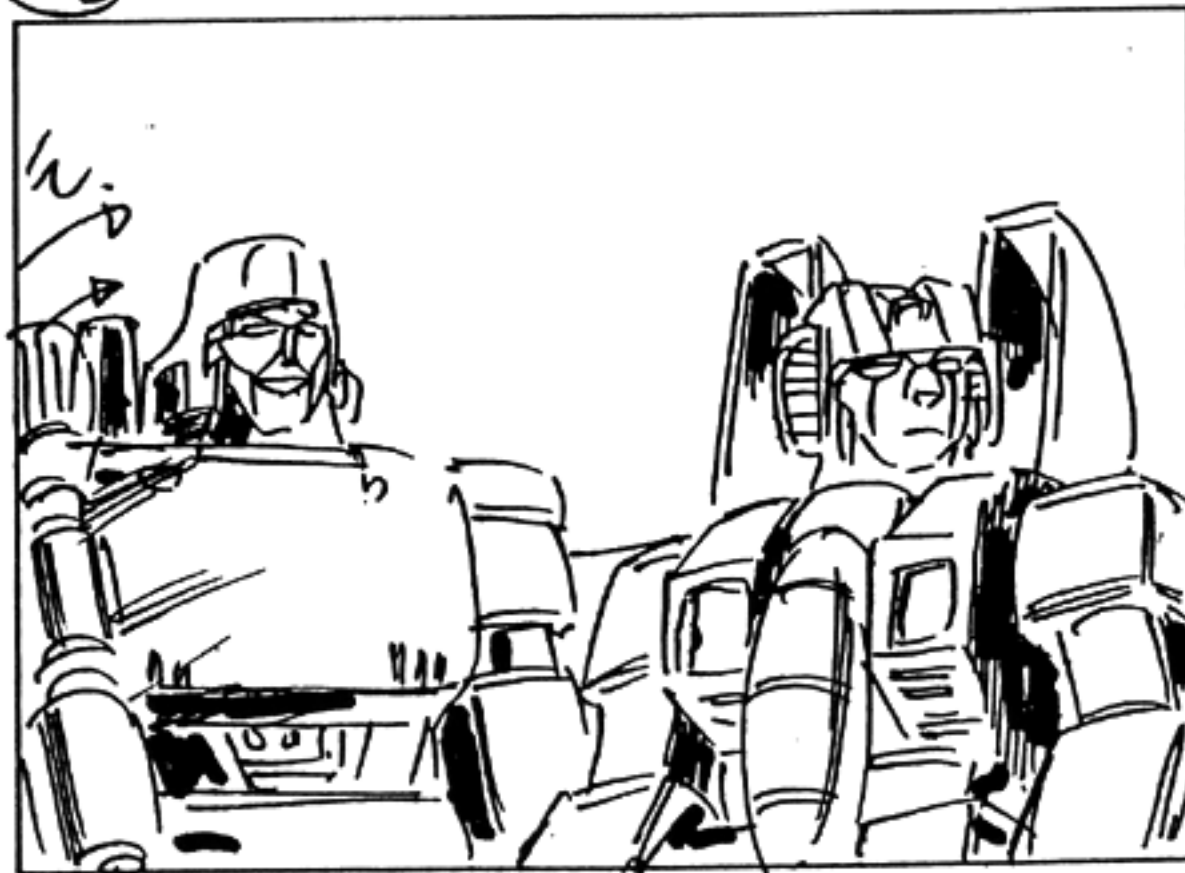

MS. STARScream & MEGATRON, WHO STEPS IN NEXT TO STARScream,

CONT.

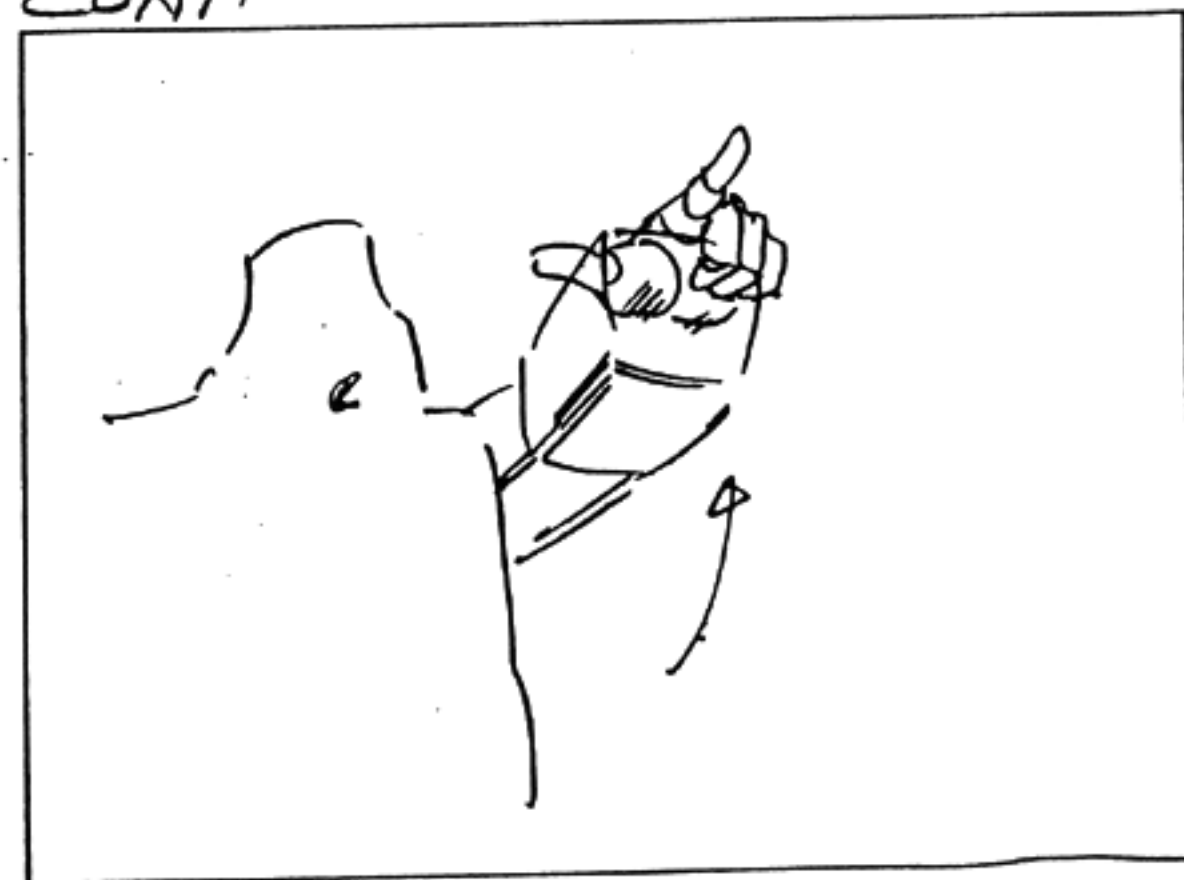

MEGATRON: I CHOOSE THESE CAVERNS AS A TEMPORARY BASE BECAUSE OF THEIR NEARNESS TO AUTOBOT HEADQUARTERS.

156

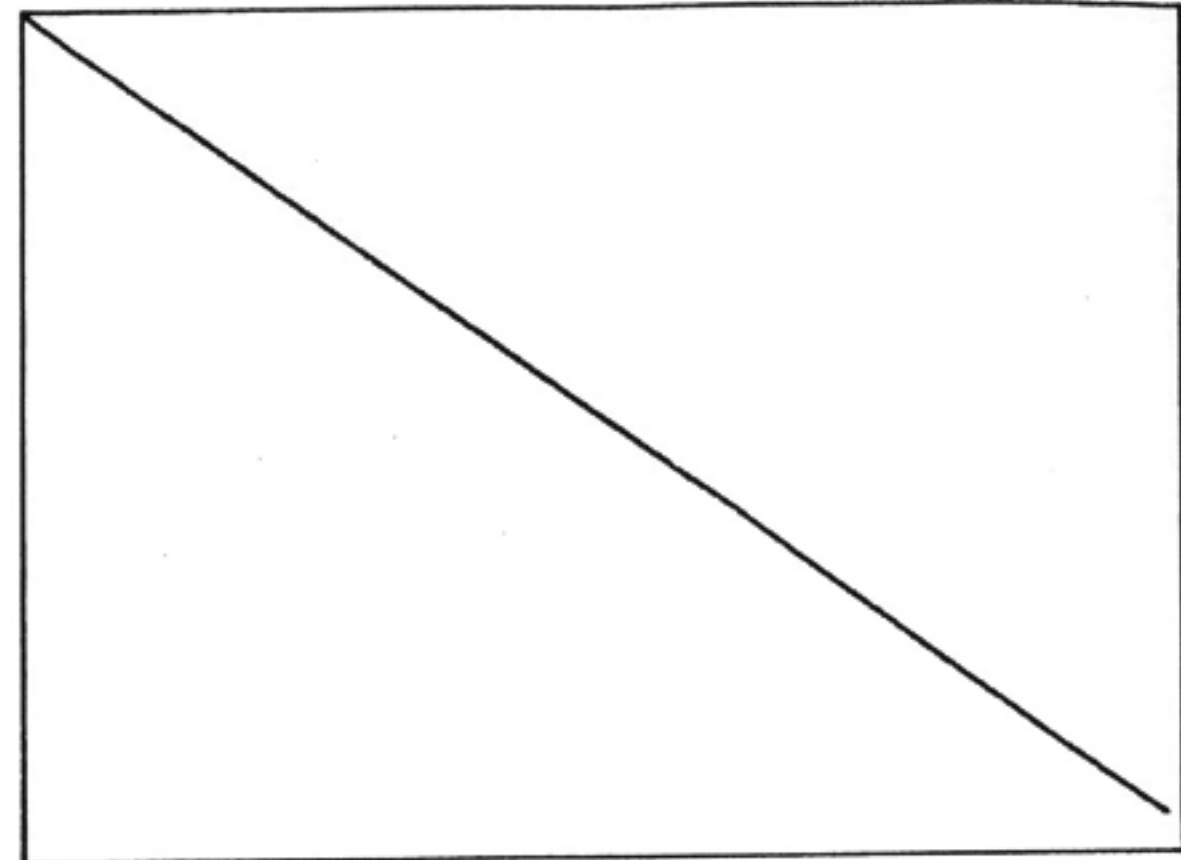
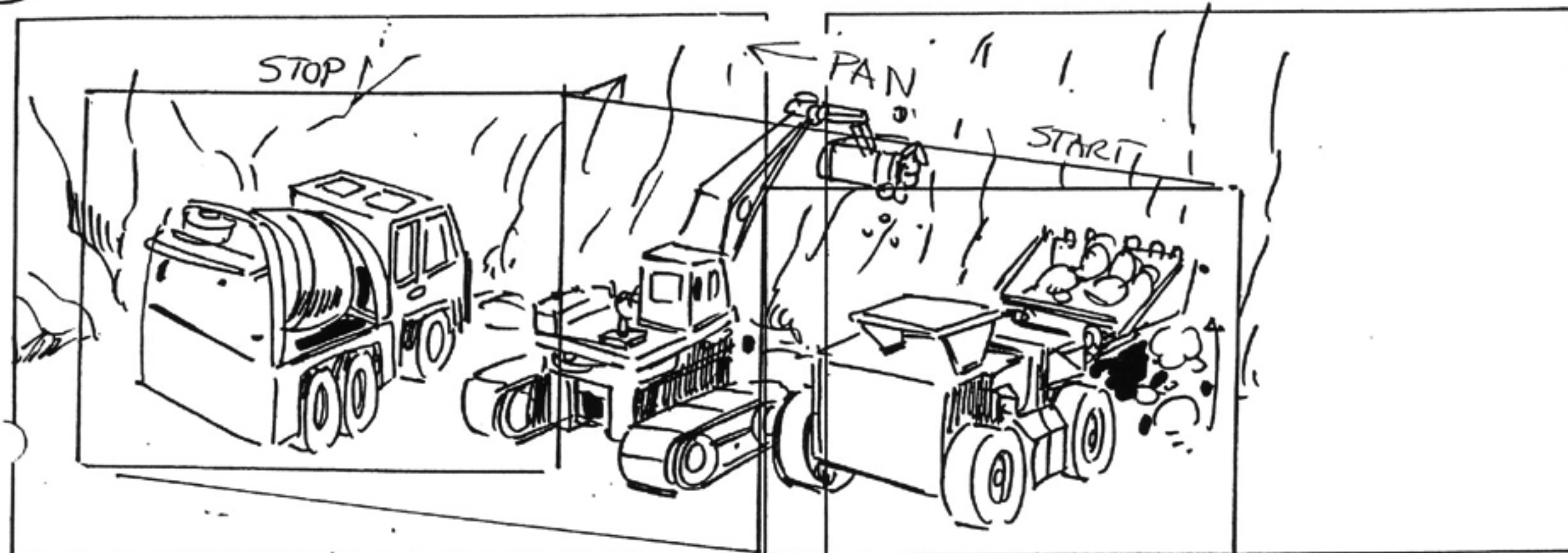

M.L.S SCRAPPER, SCAVANGER, & MIXMASTER START DIGGING.  
 MEGATRON(VO) WHILE ALL THE AUTOBOTS ARE ASSEMBLED TO WATCH MY COMBAT  
WITH OPTIMUS PRIME ...

157

CONT

CONT

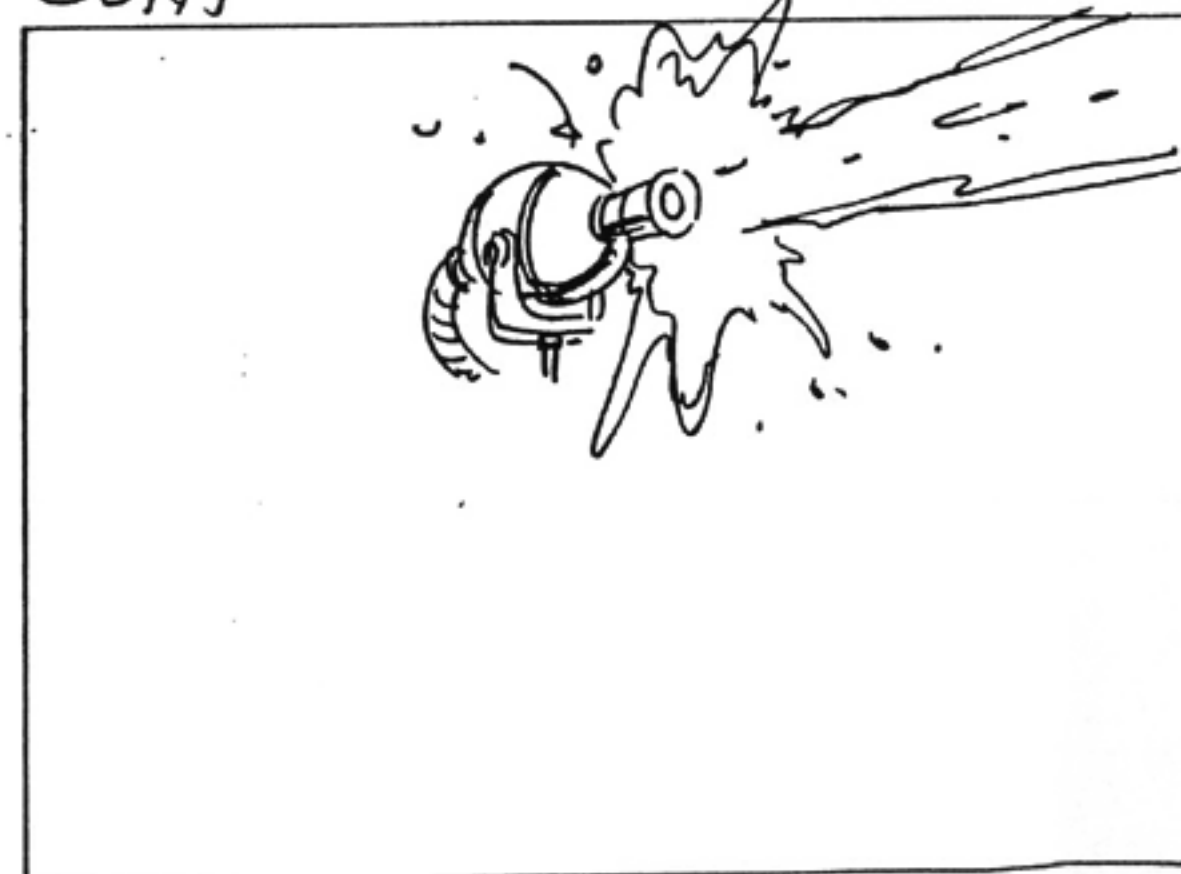
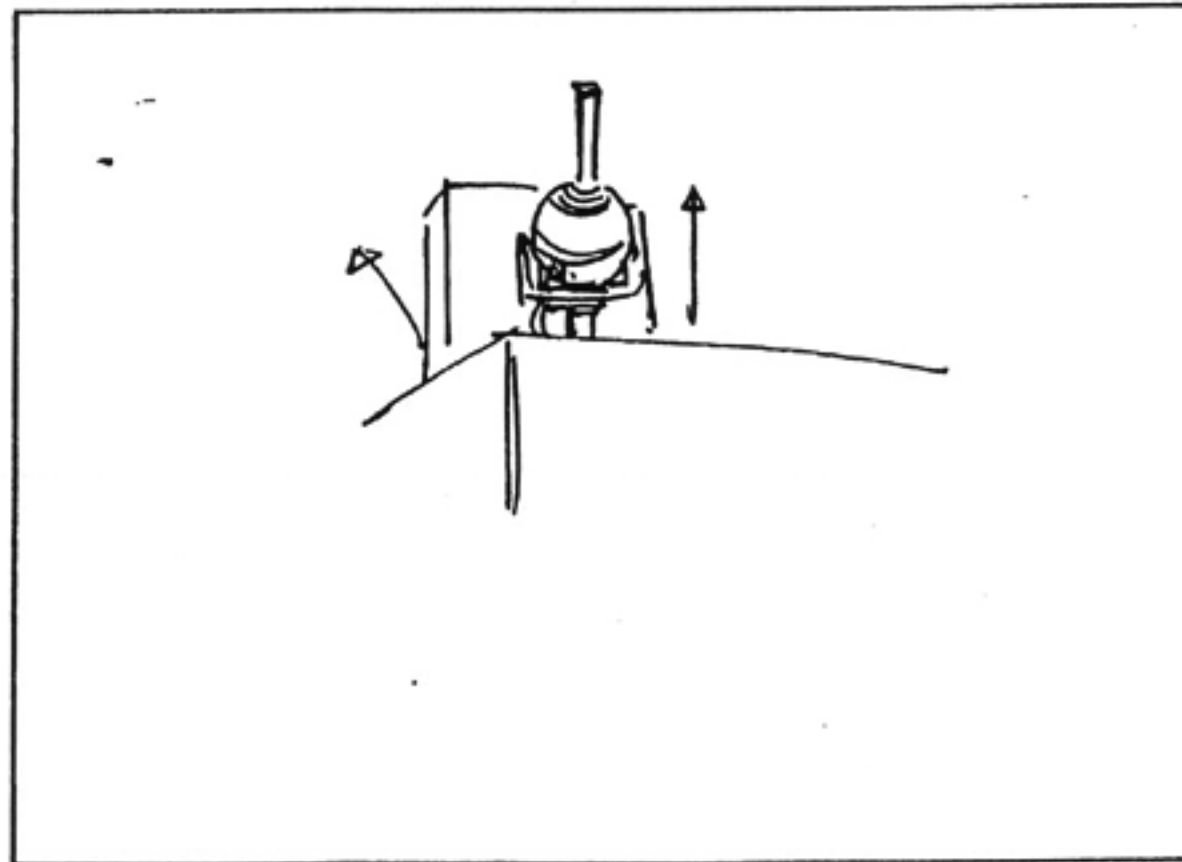
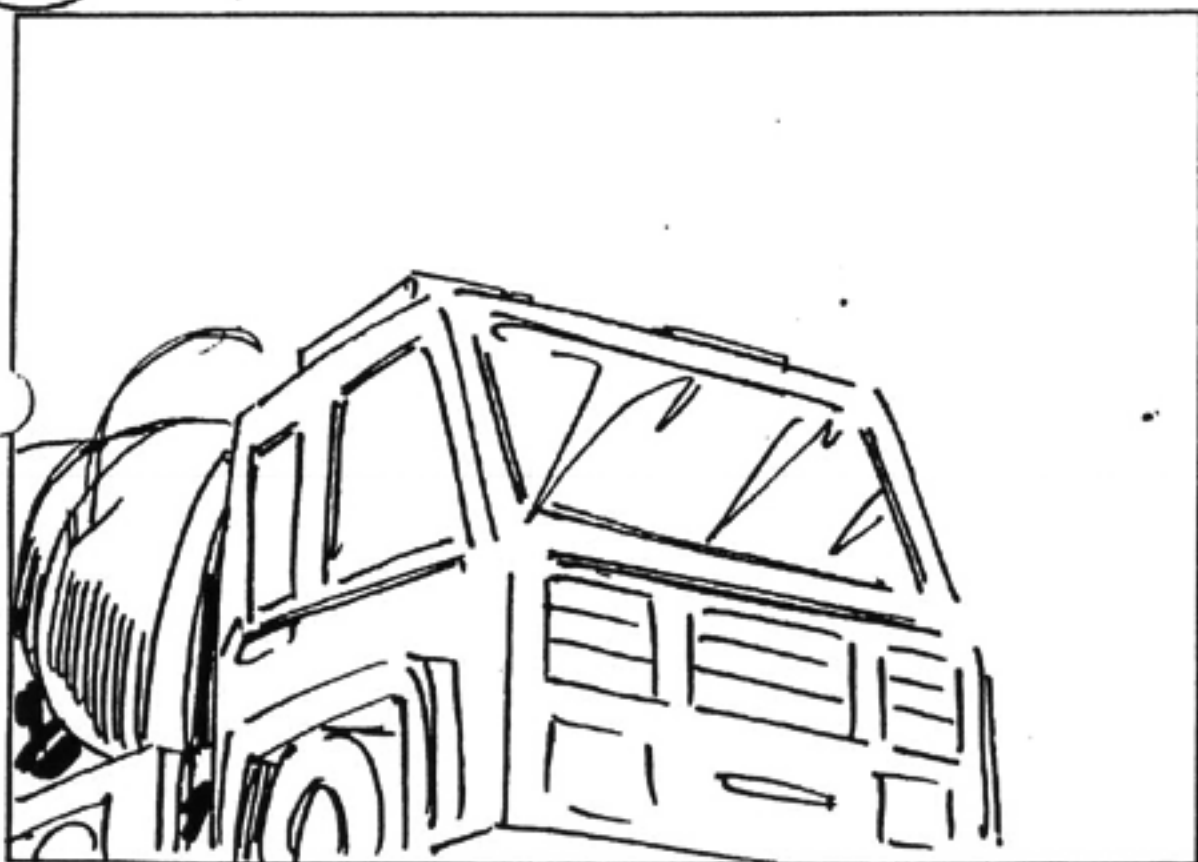

M.S. MIXMASTER, HIS MIXER ROTATES AS ... HIS CAB-CANNON MOVES INTO POSITION... AND SHOOTS OUT A STREAM OF ACID.  
 MEGATRON(VO/CONT) ... MY CONSTRUCTION CONS WILL TUNNEL THEIR WAY BENEATH THOSE HEADQUARTERS.

158

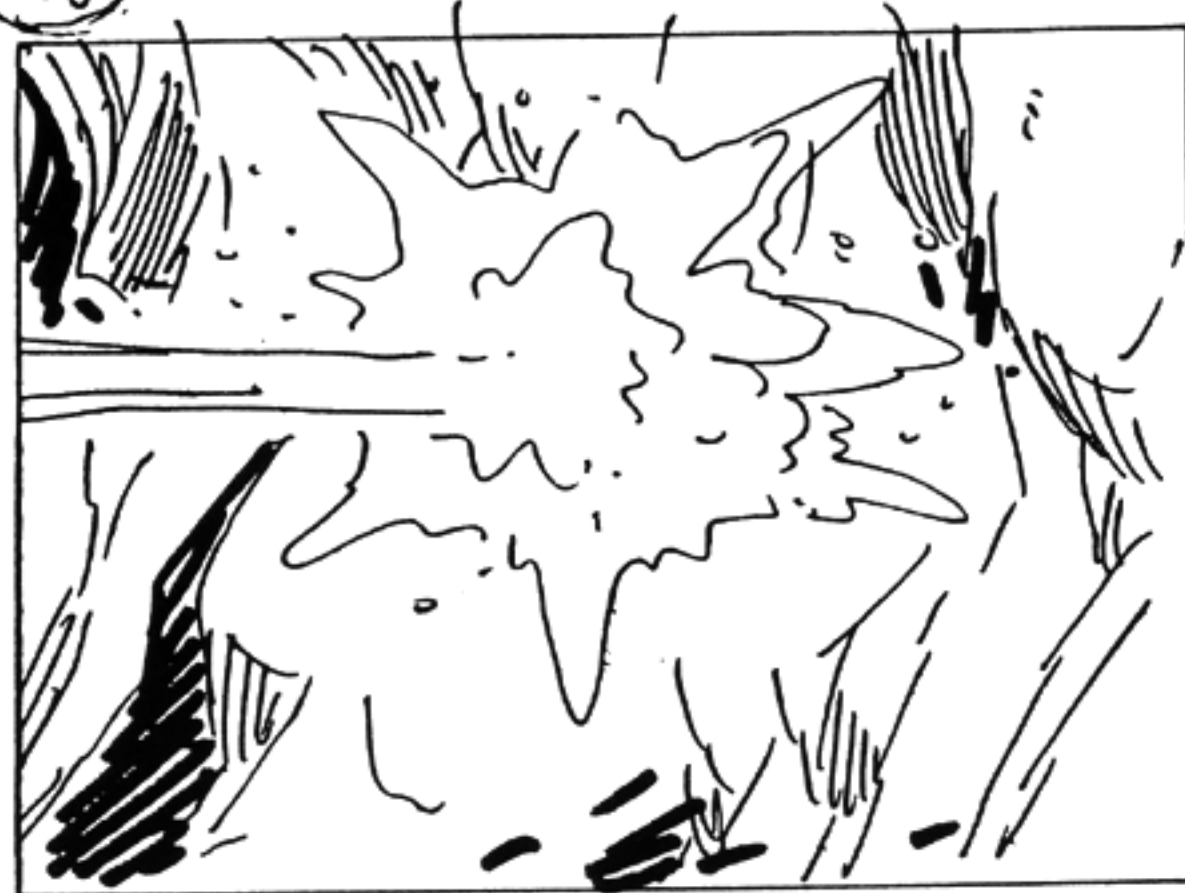
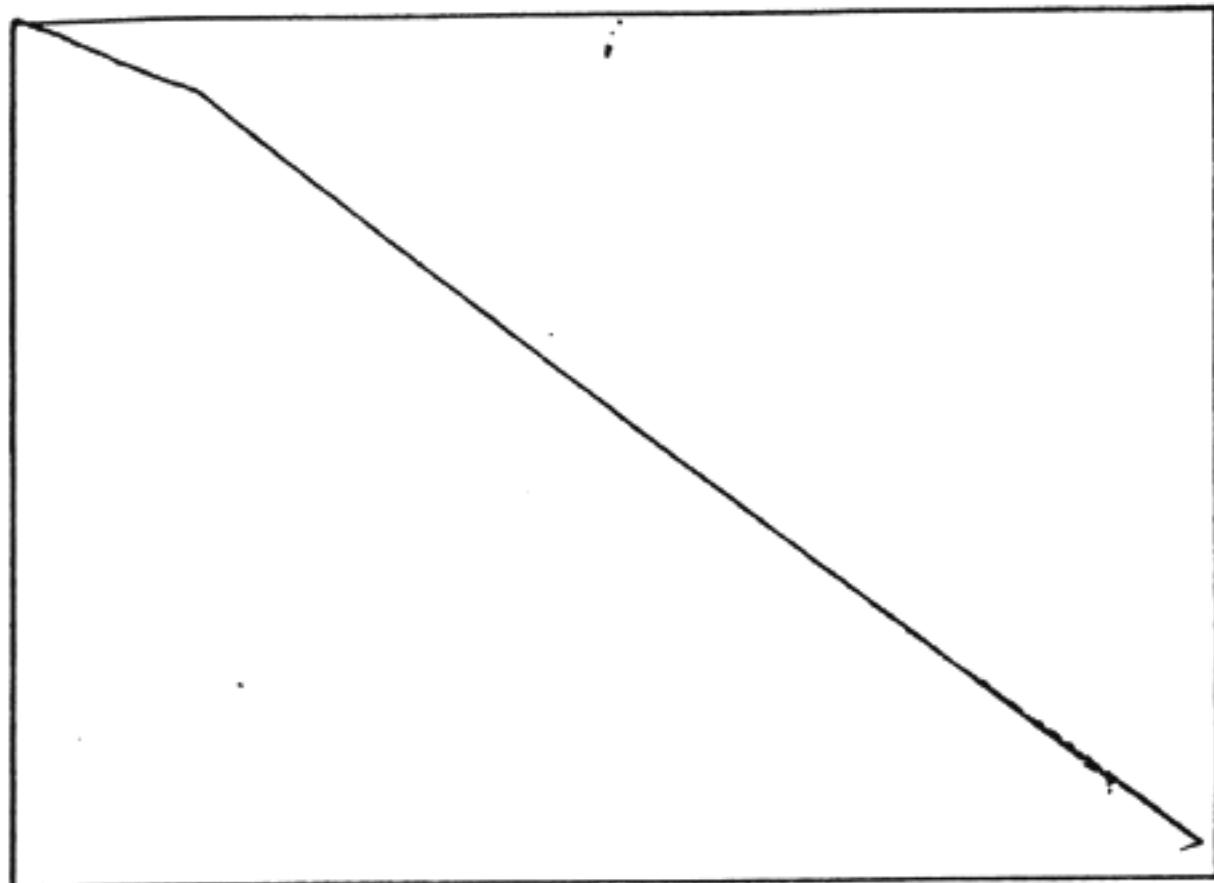

CONT

700-13

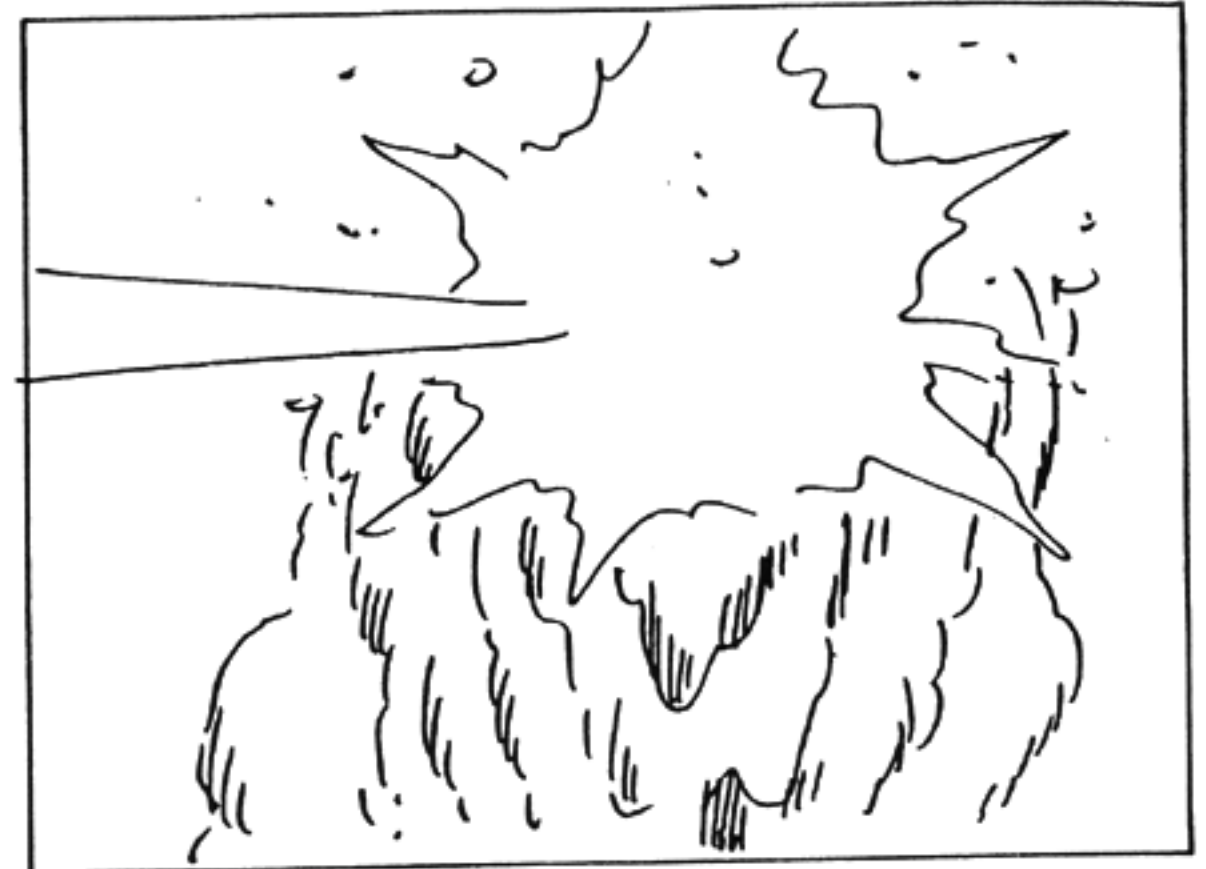

C.V. ROCK WALL. THE ACID HITS IT... AND IT STARTS TO MELT, MEGATRON (VOKONT) THEN ENTER THE CONTROL ROOM AND DESTROY TELETRANI! (LAUGHS)

CONT.

160

159



M.S. MEGATRON & STARSCREAM. MEGATRON (CONT) OPTIMUS PRIME WON'T KNOW WHAT HIT HIM! (LAUGHS)

M.3 SHOT SCAVANGER LOADING CRUMBLD ROCK INTO LONG HAUL

160  
CONT.

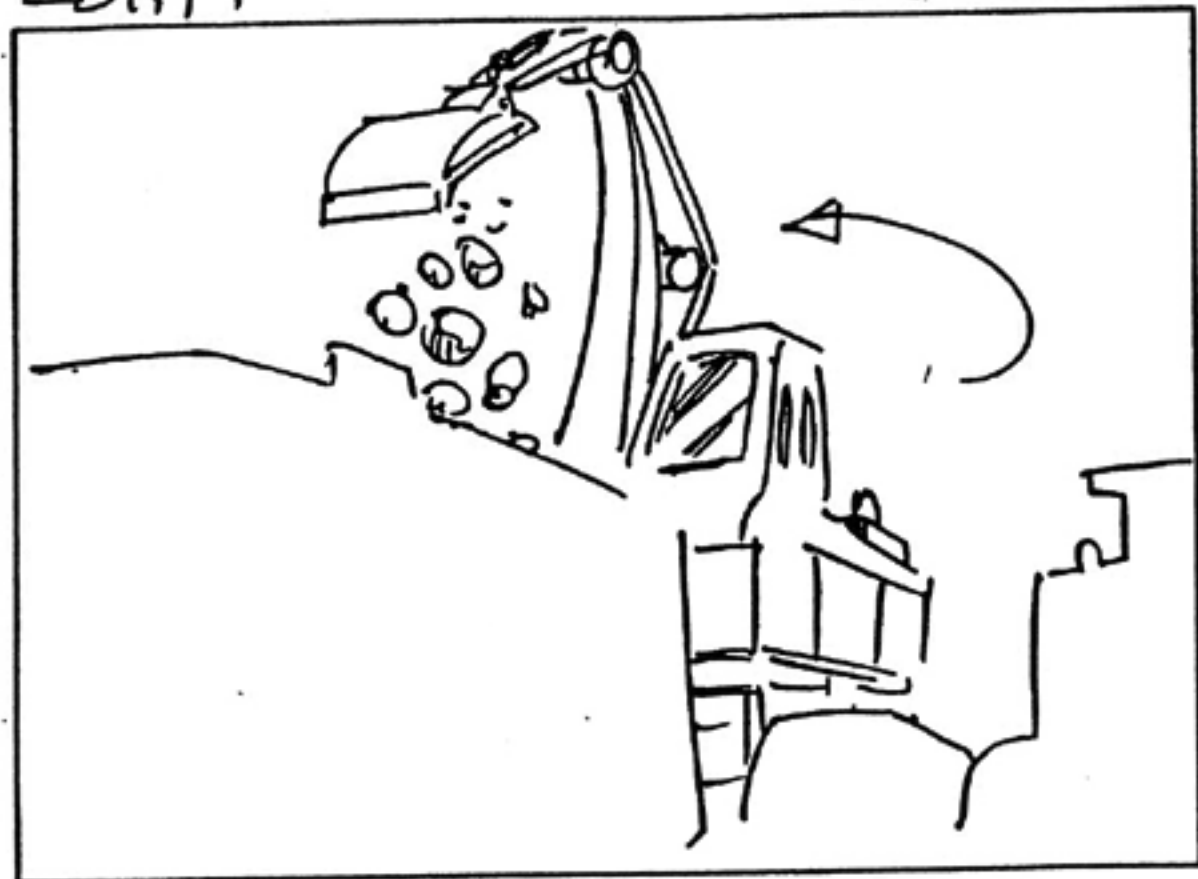

30

TRANSITION

# 1

161

TRUCK IN 700-13

START

51

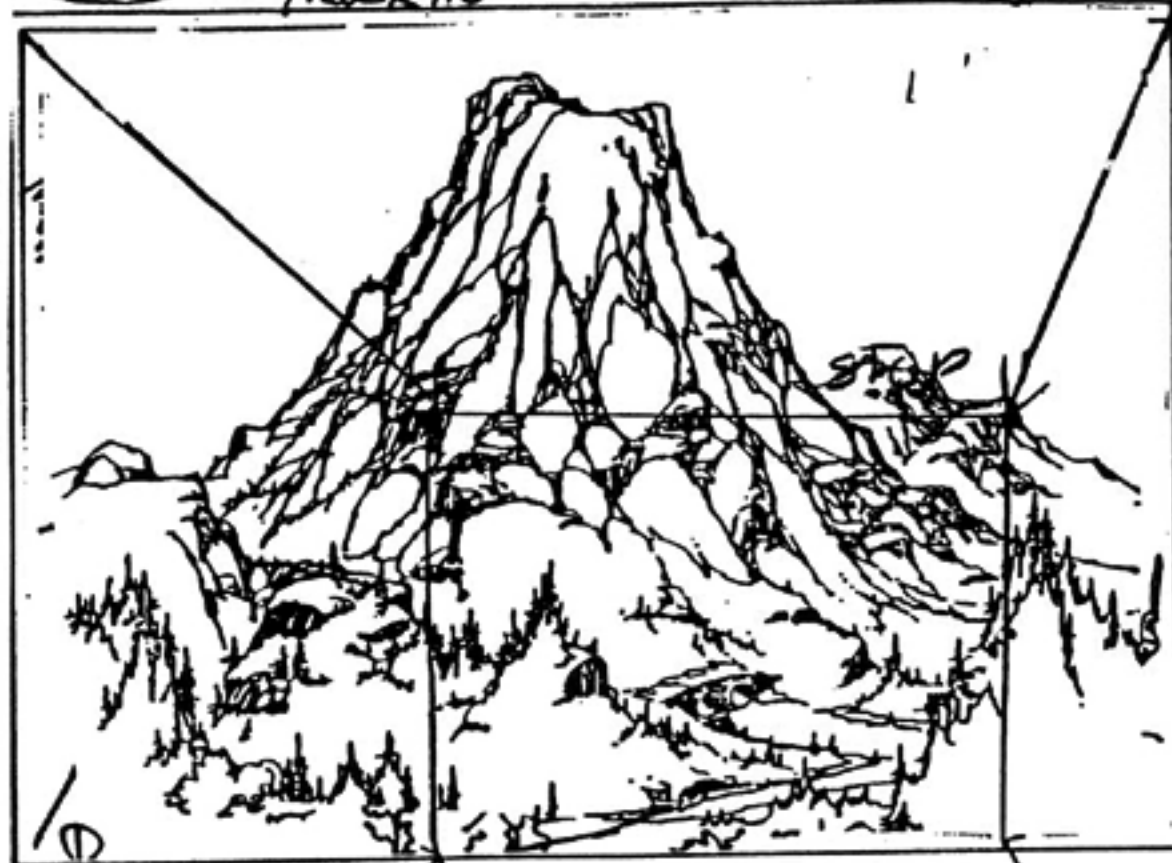

L.S. THE AUTOBOT HEADQUARTERS  
SPIKE (VO) I'M STILL NOT CRAZY ABOUT THIS  
COMBAT DEAL, OPTIMUS...

162

START

PAN -

STOP

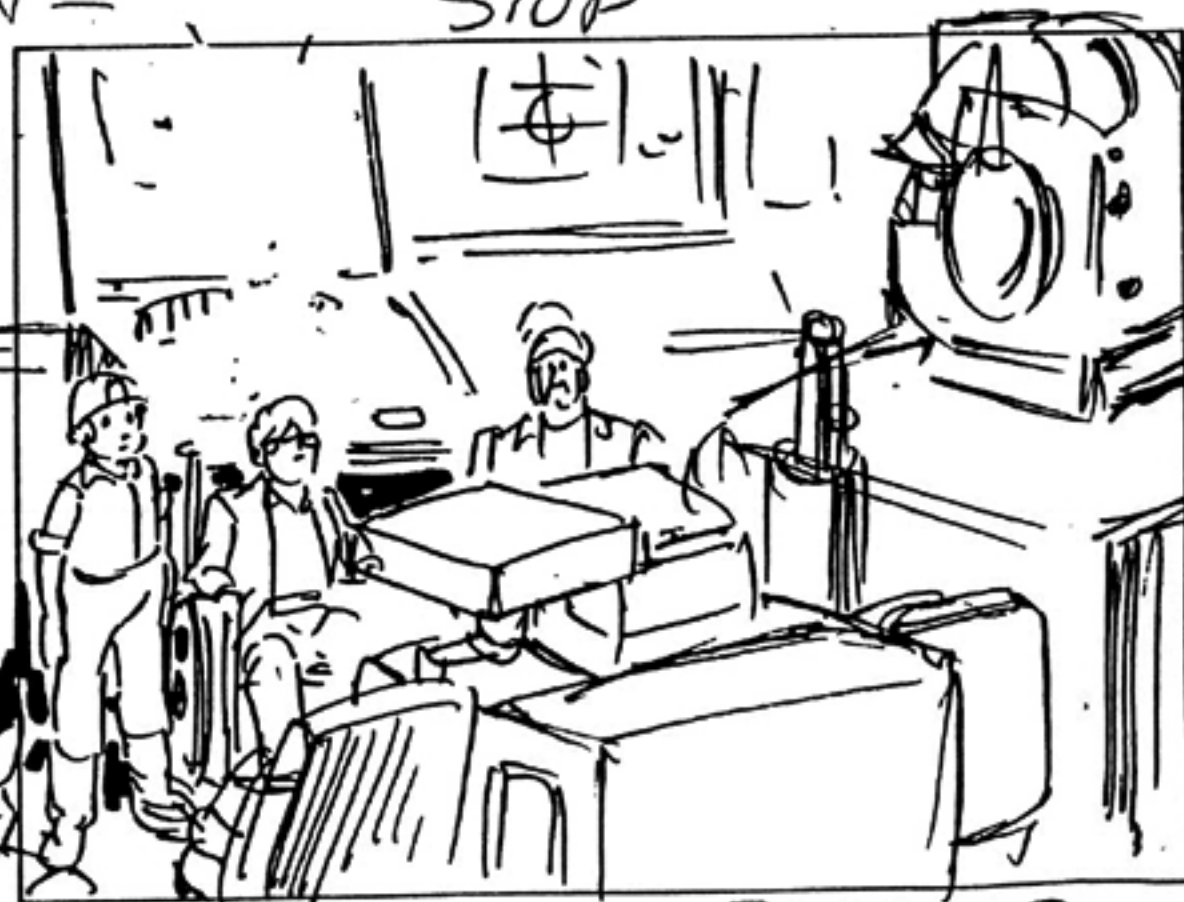
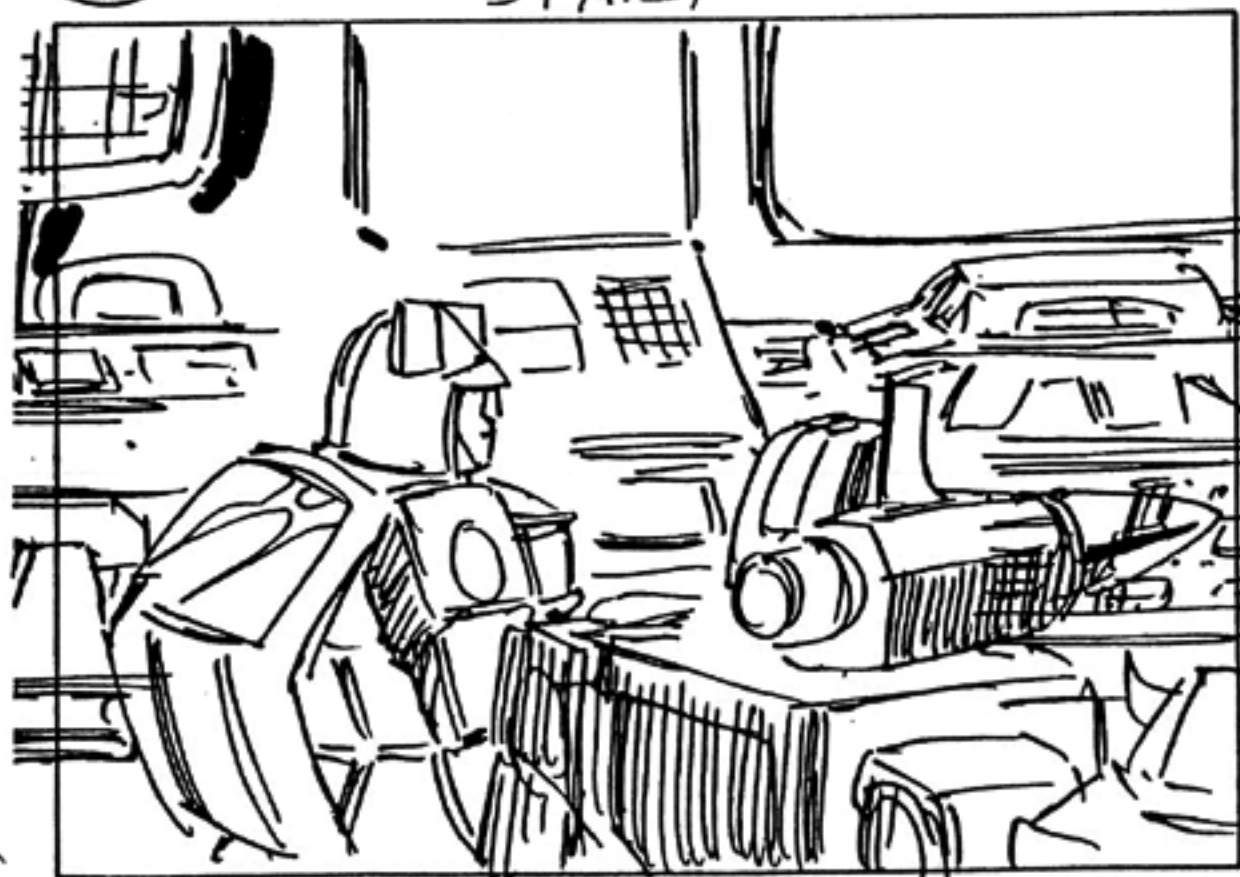
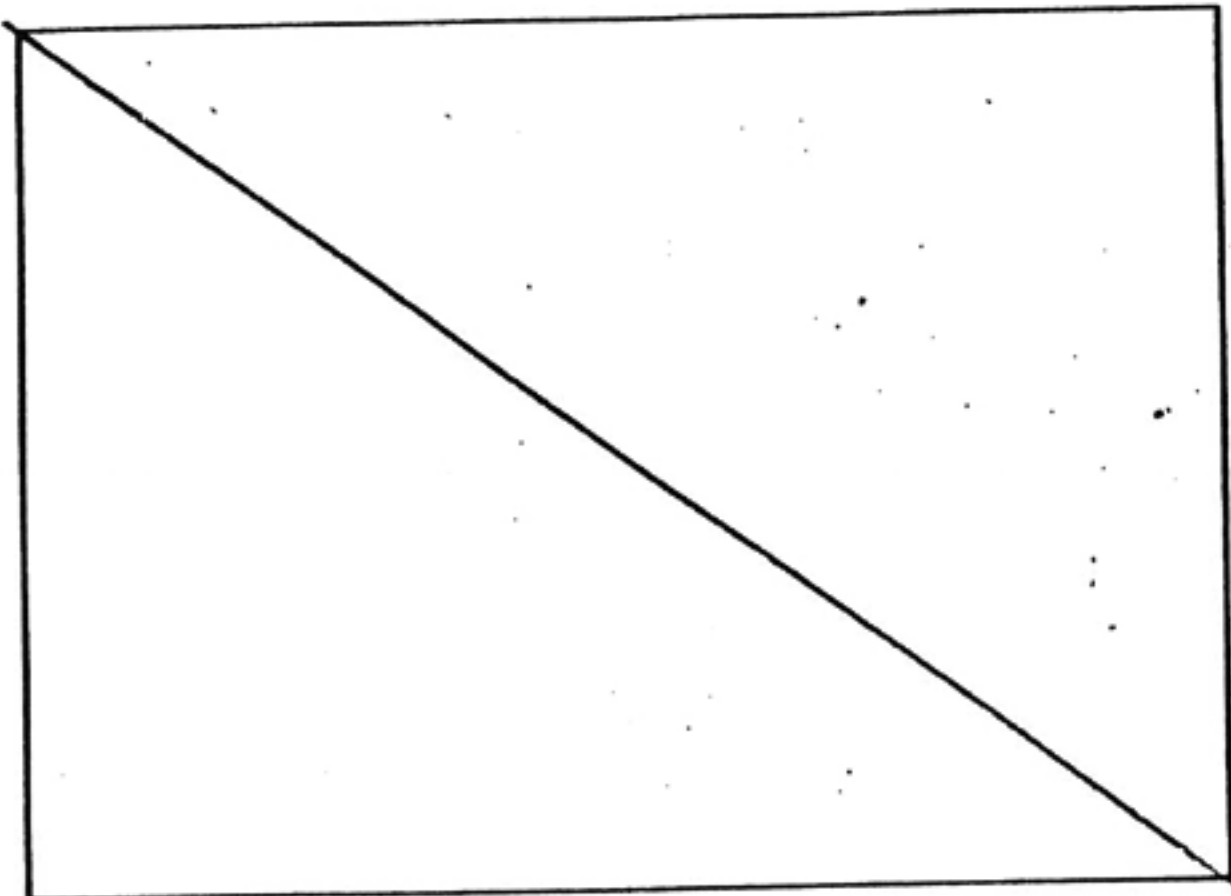

M.L.S. THE AUTOBOTS & SPARKPLUG, SPIKE & CHIP. STAND NEAR TELETRAN I.  
SPIKE: WE ALL KNOW HOW TRICKY MEGATRON CAN BE.

163

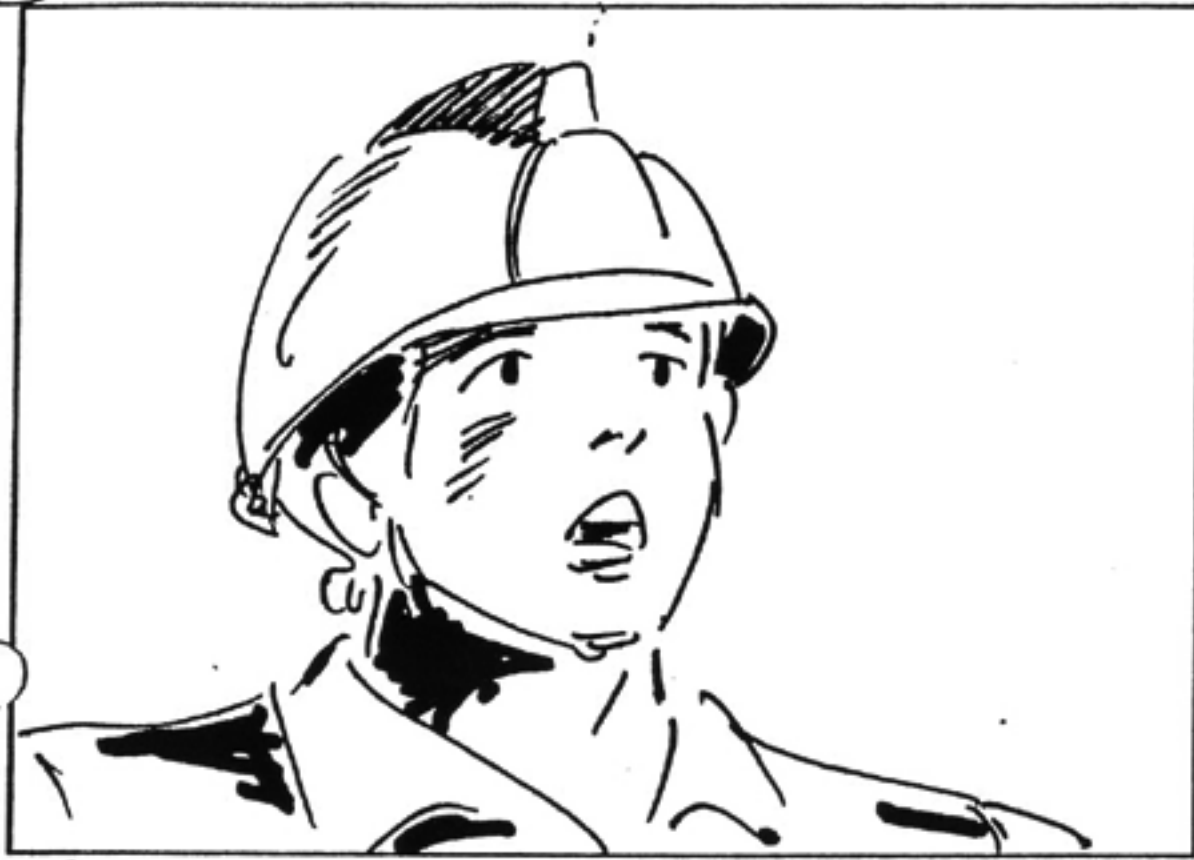

C.U. SPIKE:  
SPIKE: I MEAN, THEY DON'T CALL THOSE  
CREEPS DECEPTICONS FOR NOTHING.

164

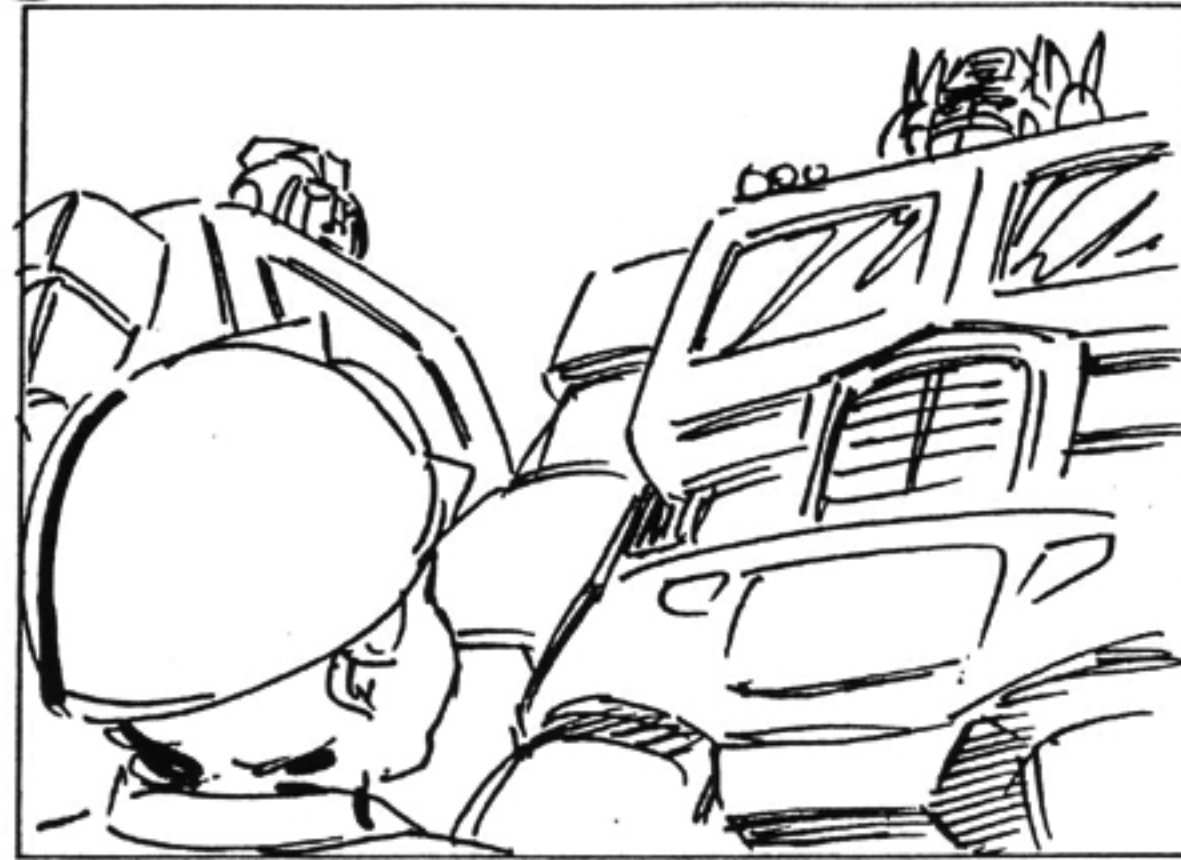

U.S. PRIME & IRONHIDE, SPIKE F.G.  
PRIME: THE CODE SPECIFIES A FAIR  
BATTLE, SPIKE. I'M CONFIDENT I  
CAN BEAT MEGATRON ON THAT CONDITION.

165

700-13

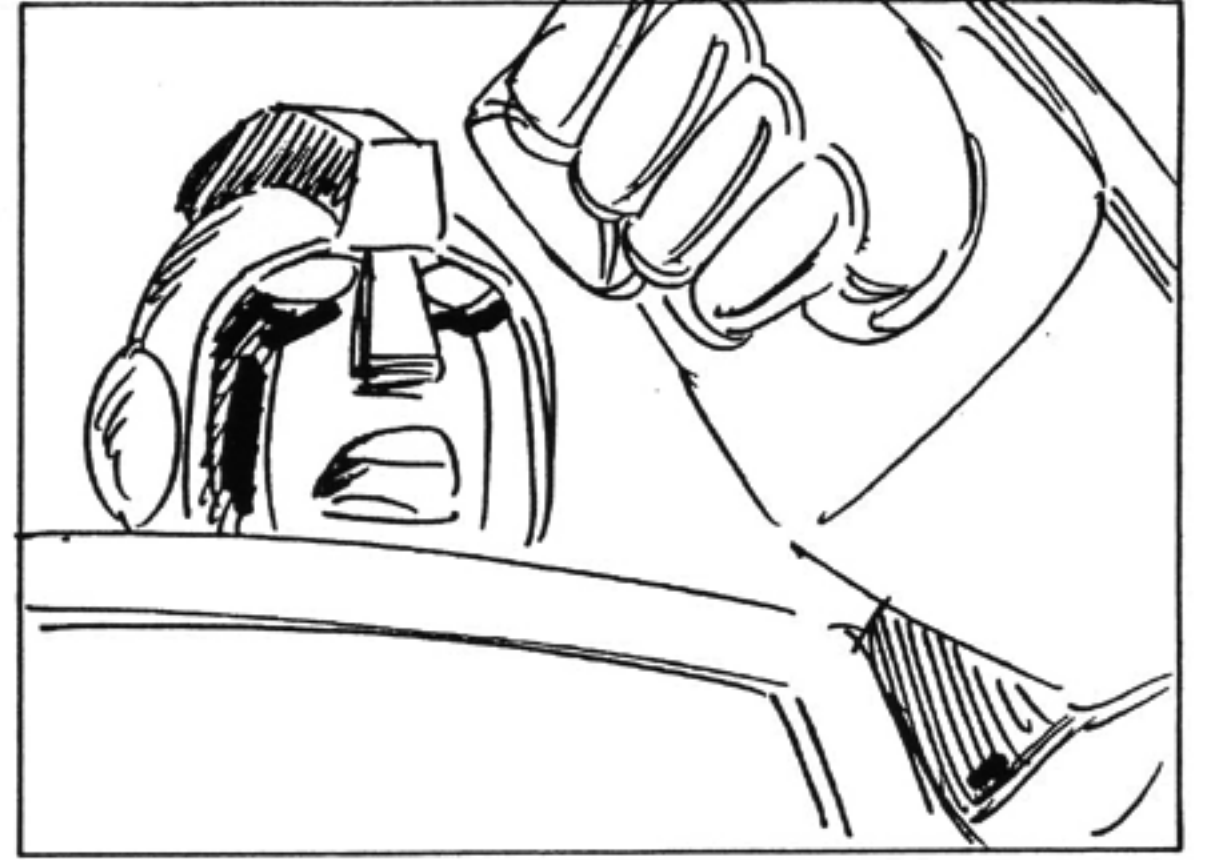

C.U. IRONHIDE.  
IRONHIDE: AND IF MEGATRON TRIES ANYTHING  
CUTE, WE'LL ROTATE HIS CIRCUITS.

166



C.U. PRIME. NO, IRONHIDE. THE LAW OF  
CYBOUTON MUST BE OBEYED AND A ROBOT  
HONOR MUST BE PRESERVED. I WILL FIGHT  
MEGATRON ALONE. I HAVE GIVEN MY WORD.

167



M.C.U. TELETRAI. ITS LIGHTS FLASH AND CODED IMAGES FLASH ON THE SCREEN.  
MEGATRON (VO) BEIDES TELETRAI I WILL TELL US IF HE DOES NOT ABIDE  
BY THE RULES.

CONT

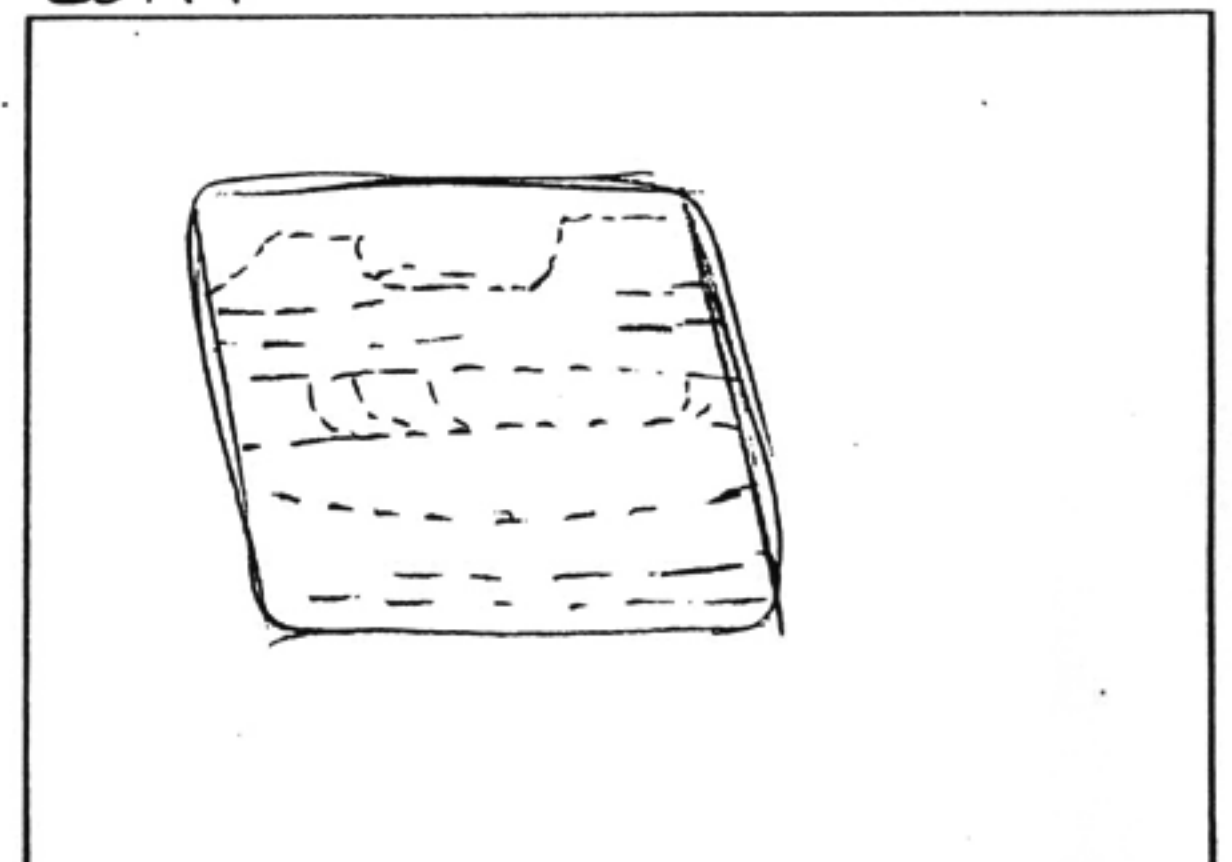

168

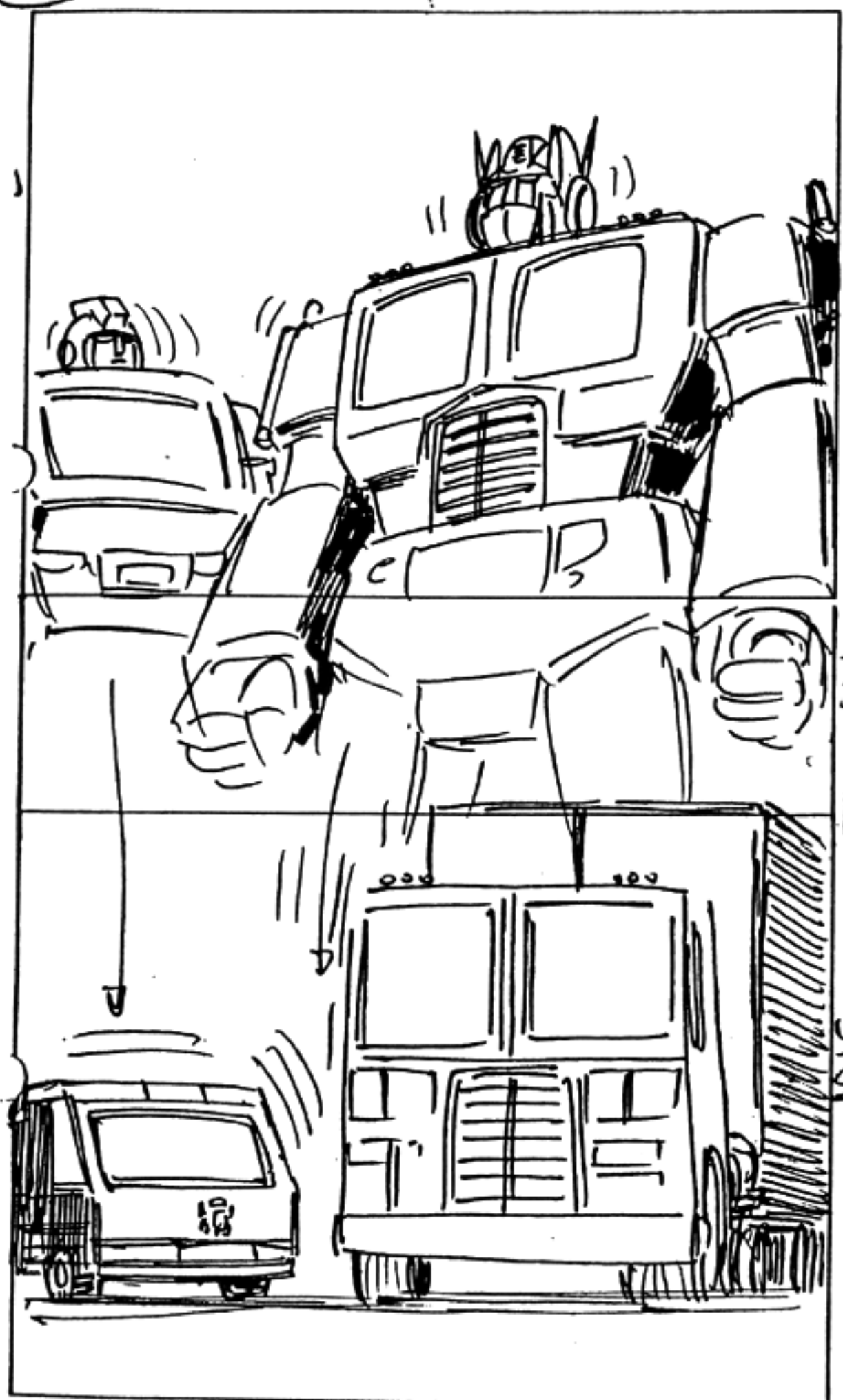

M.S. PRIME & IRONHIDE - TRANSFORM!  
 PRIME: THE TIME FOR THE BATTLE APPROACHES.  
 AUTOBOTS... TRANSFORM!

169

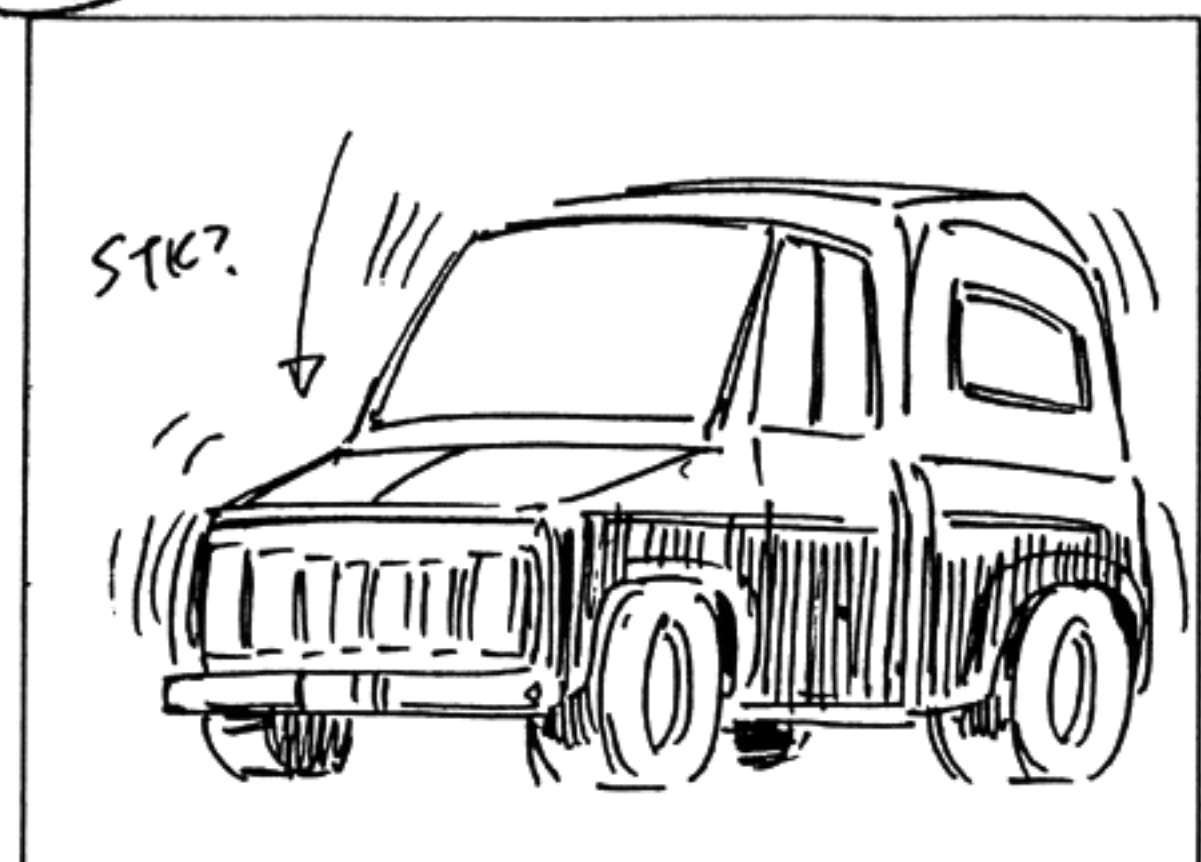

M.L.S. TRAILBREAKER TRANSFORMS

170

700-13

53

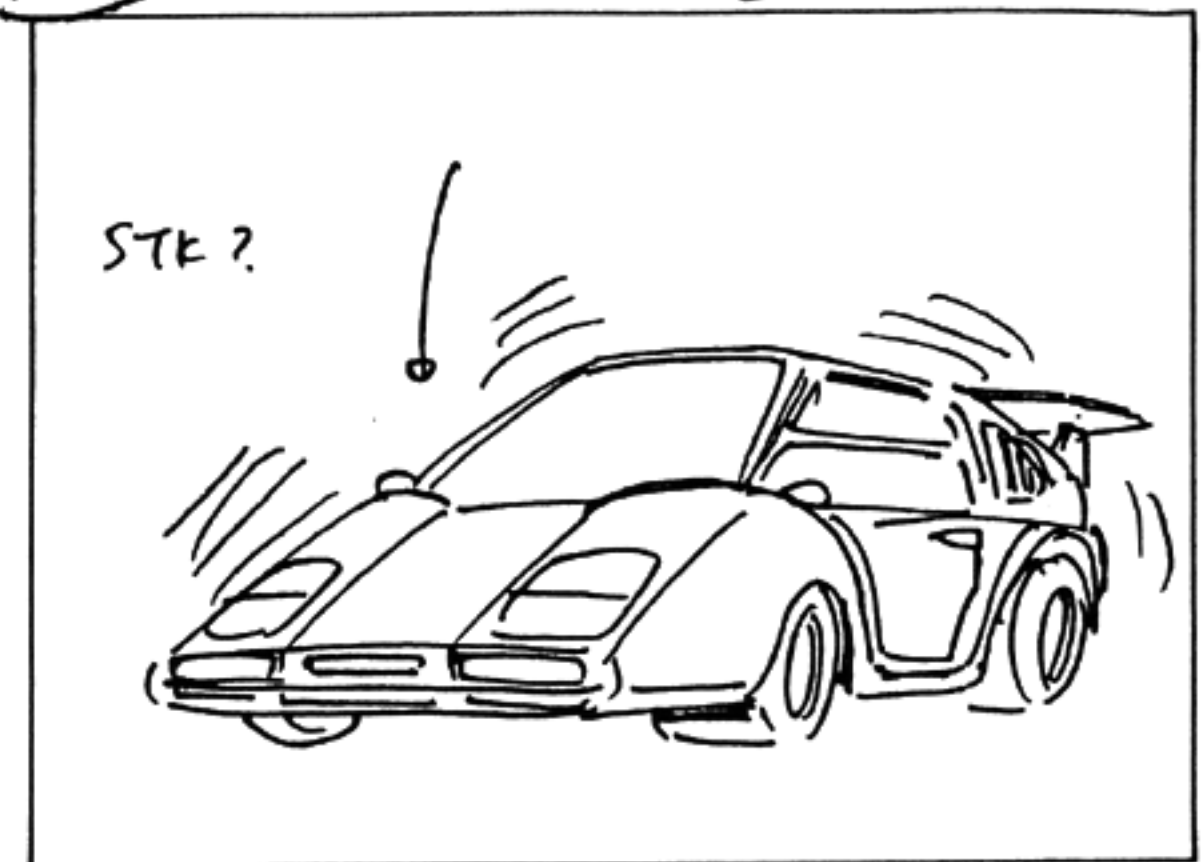

M.L.S. SIDESWIPE TRANSFORMS.

171

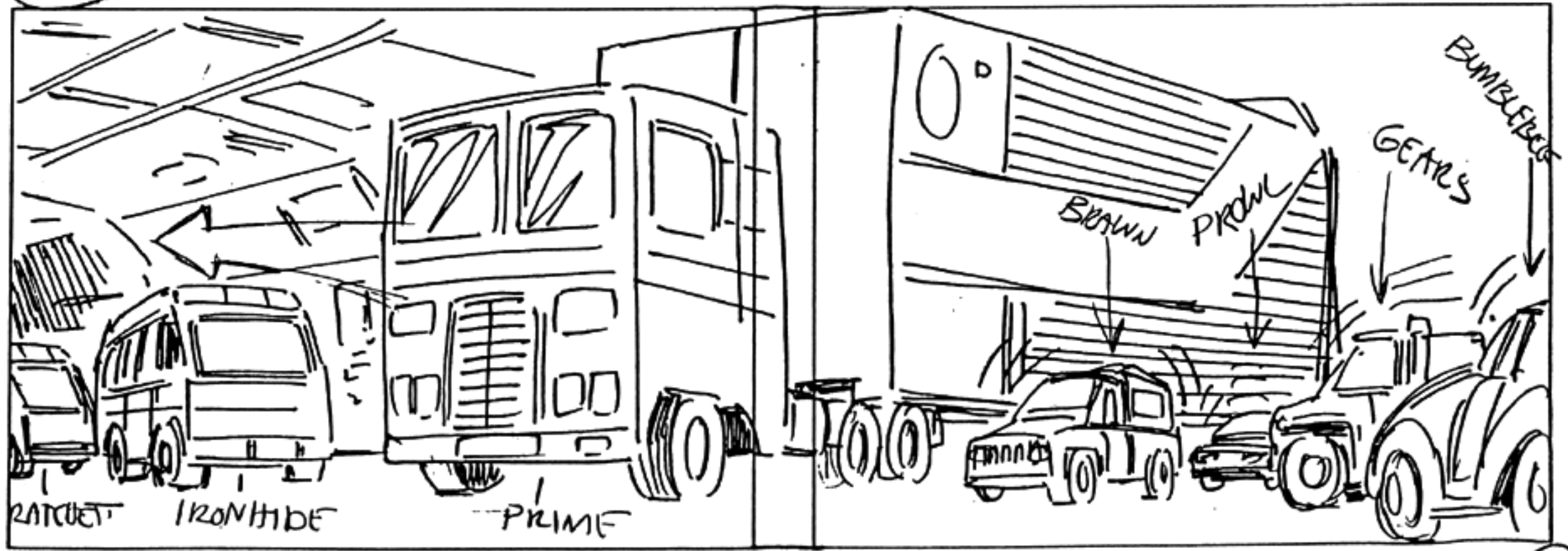

L.S. VARIOUS AUTOBOTS TRANSFORM, ⓐ AND PRIME LEADS THEM OUT.  
 PRIME: AND ROLL OUT! ⓑ

172

700-13

54

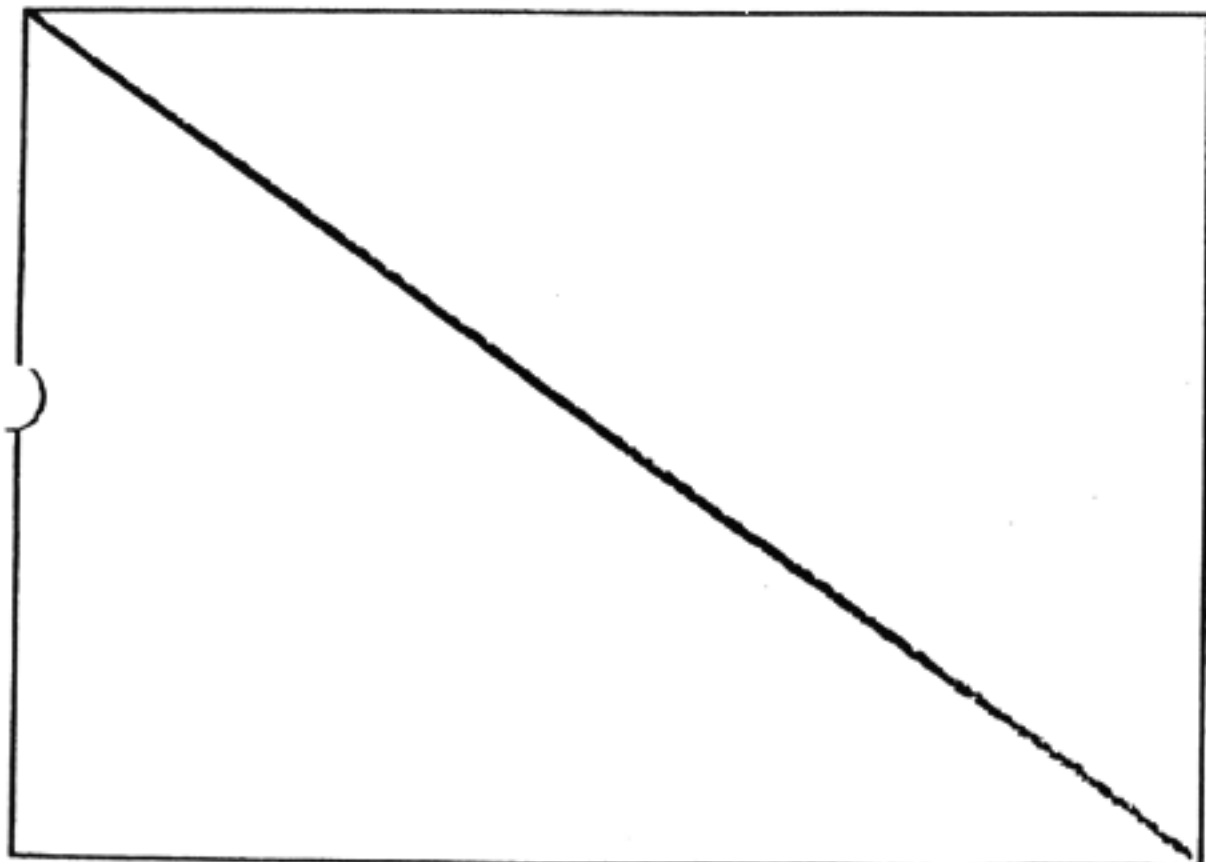
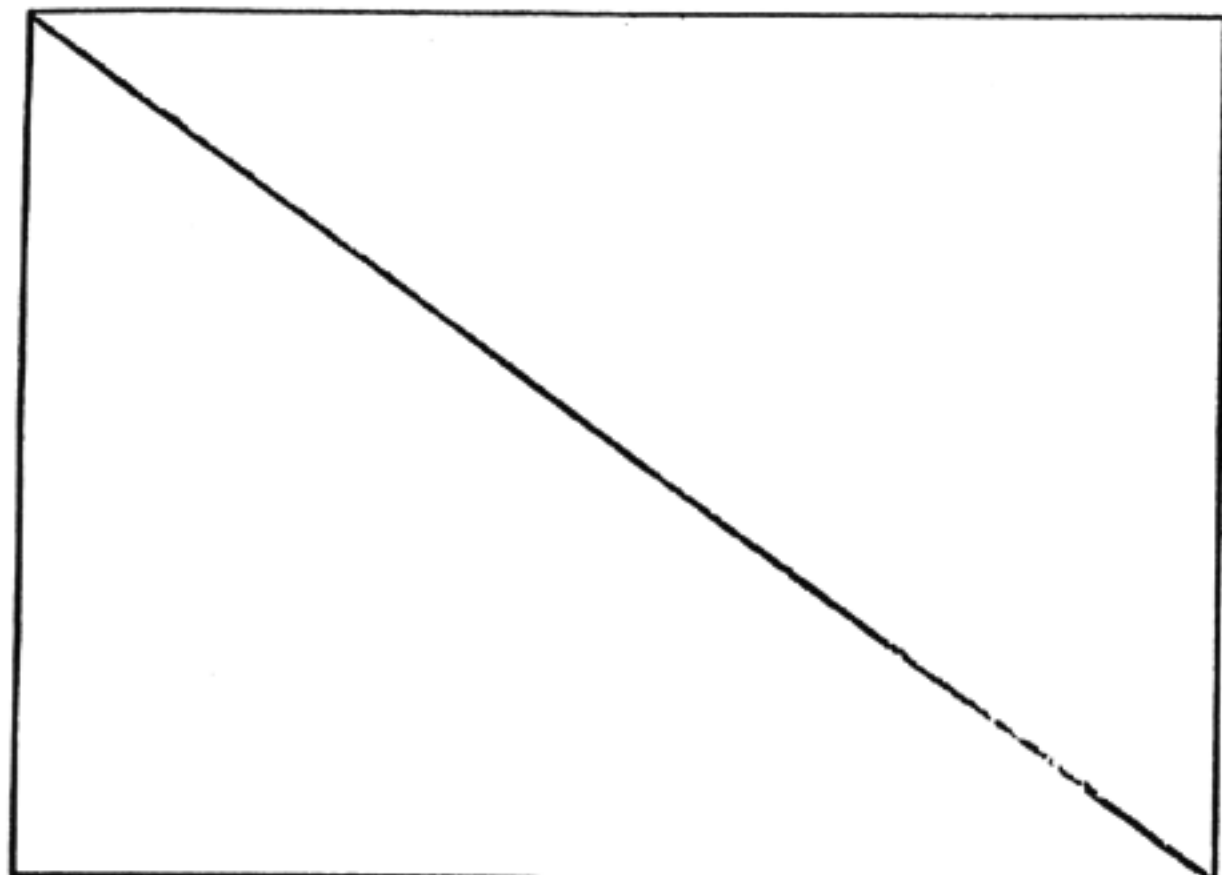

STOP.

PRIME

IRONHIDE

RATCHET

SINGWIFE

POLARBEAR

WHEELJACK

PUNCH

JAZZ

MIRAGE

0.4

X-DISS TO

O.S.

X.L.I.S. PRIME LEADS THE ENTIRE AUTOBOT CARAVAN OUT OF THE AUTOBOT HEADQUARTERS

173

PAN →

B.G. START

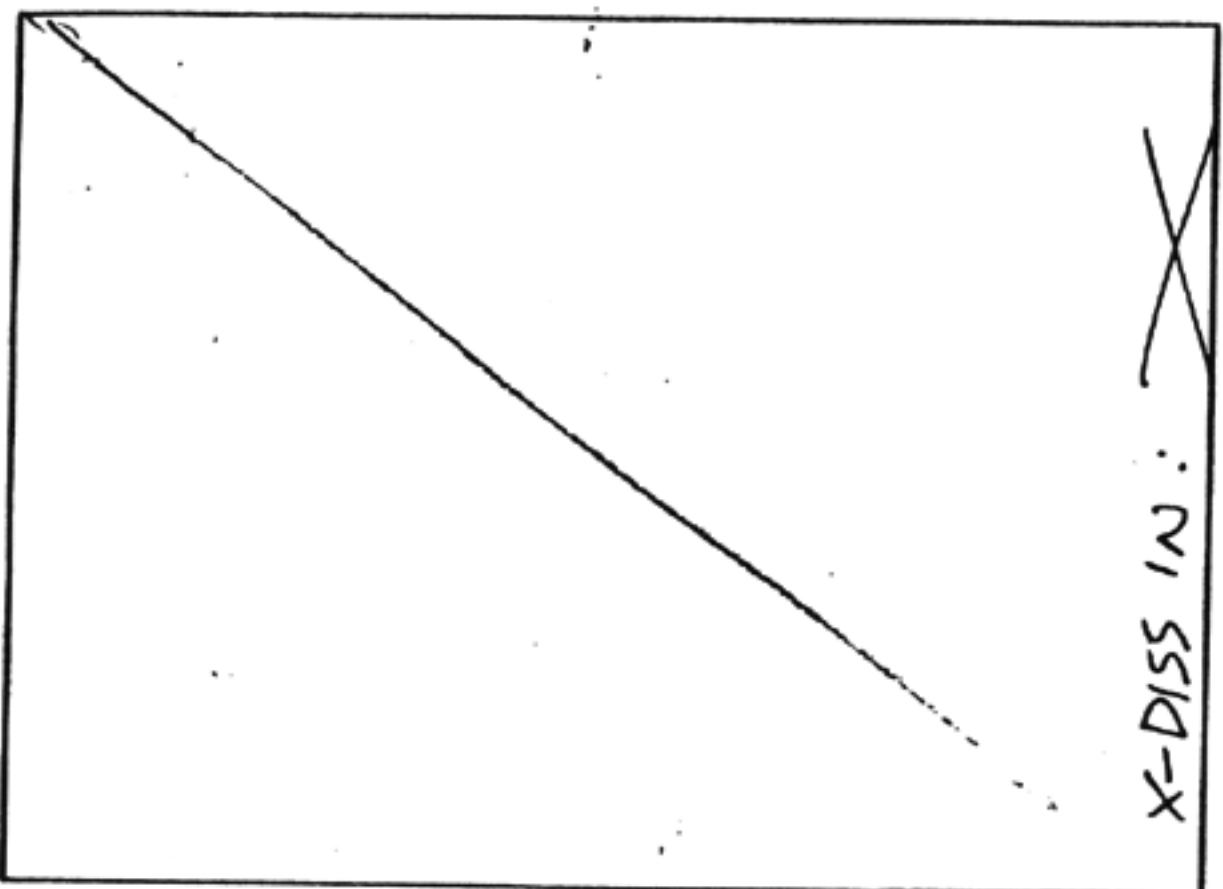

X-DISS IN:

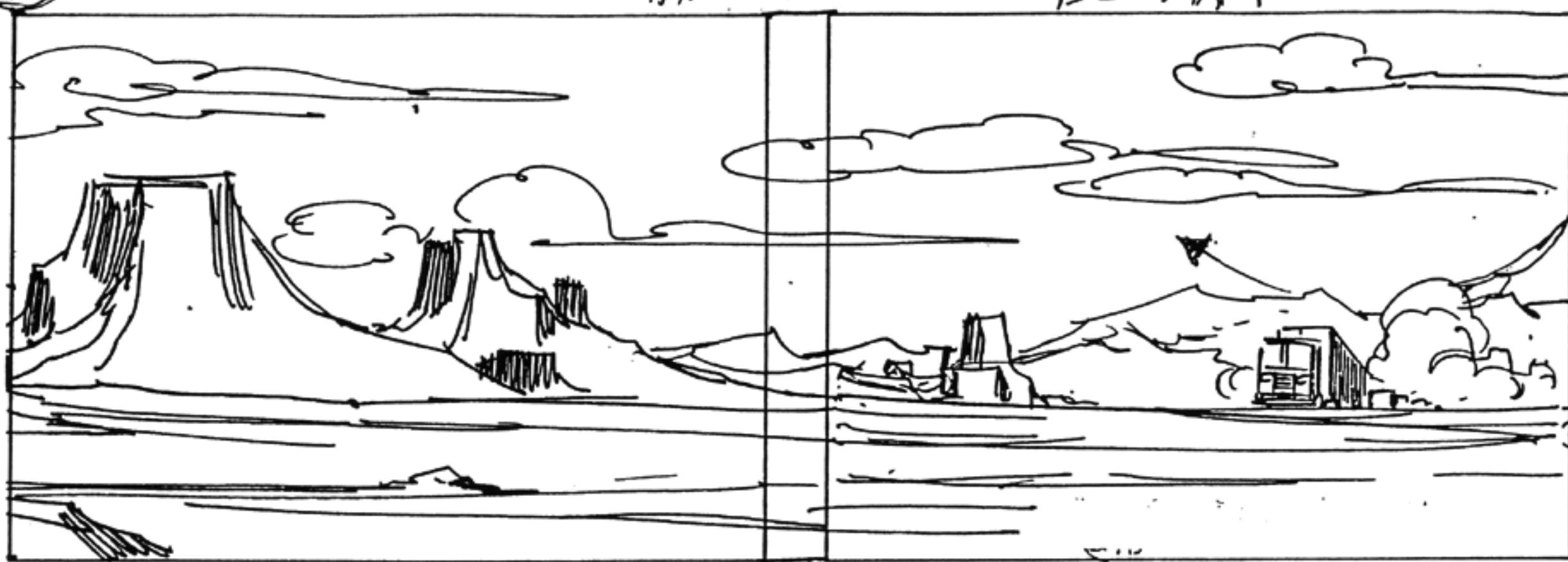

X.L.S. THE DESERT. PRIME LEADS THE AUTOBOT CONVOY ACROSS THE VAST LANDSCAPE.

174

PAN B.G.

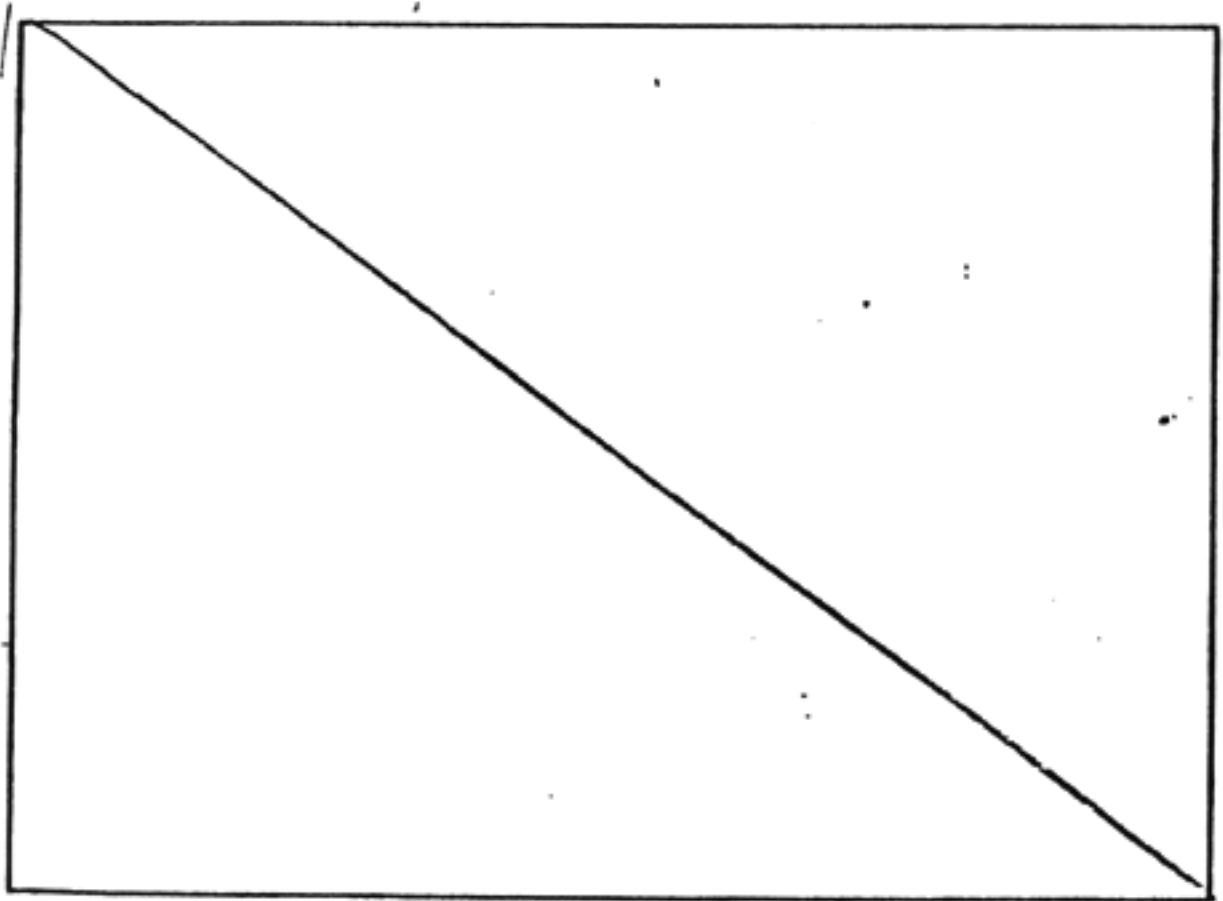

CONT

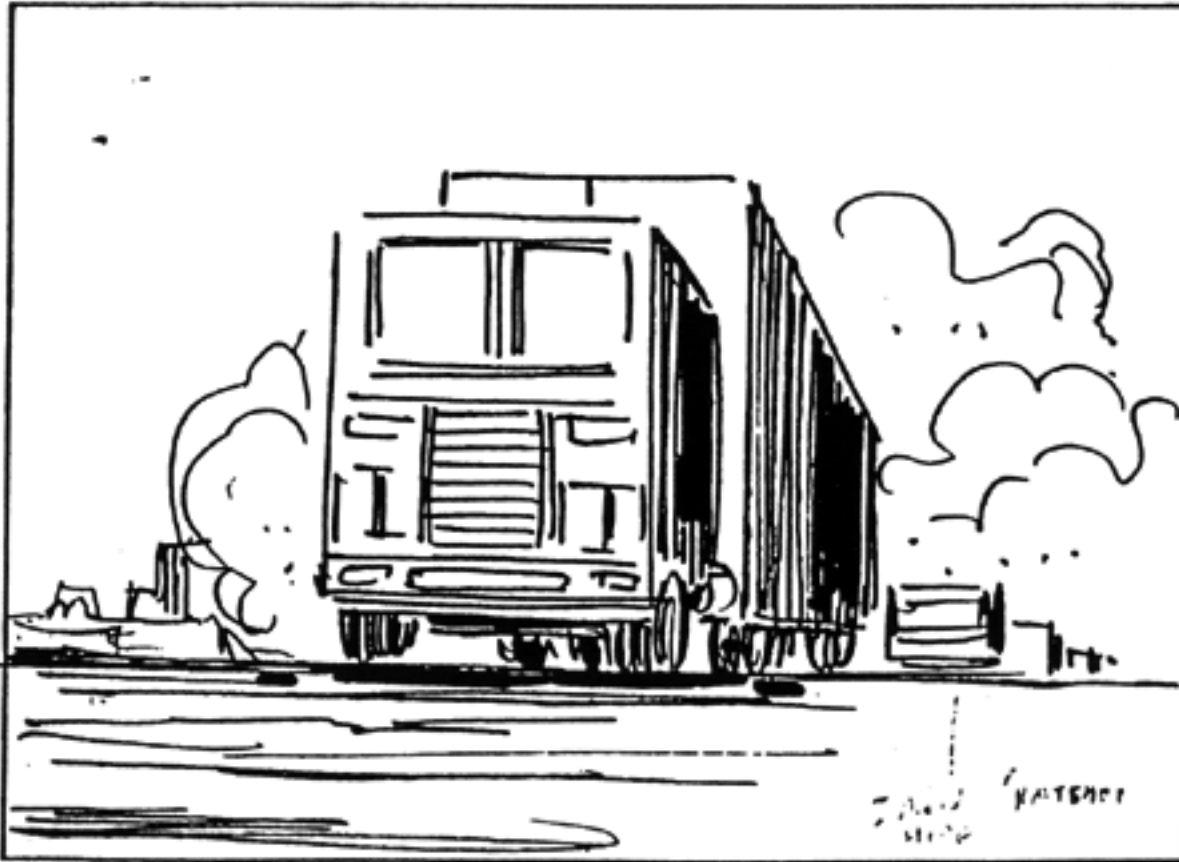

C.V. PRIME'S CAB (CHIP, SPIKE, SPARK PLUG)  
CHIP: ACCORDING TO MY CALCULATIONS,  
YOU SHOULDN'T HAVE MUCH TROUBLE, OPTIMUS.

175

ICAN BG



2 SHOT CHIP & SPIKE  
CHIP (CONT) YOUR STRENGTH IS FAR GREATER  
THEN MEGATRON'S.

177



C.U SPIKE SPIKE: I KNOW YOU  
WON'T! YOU'RE NO QUITTER!

cont



SPIKE: STOMP HIM GOOD, OPTIMUS!  
HE'S HAD IT COMING FOR A LONG,  
LONG TIME. B.G PAN

178



MICU. PRIME'S CAB.  
SPARKPLUG. HEY, GUYS...

176

B.G PAN 700-13

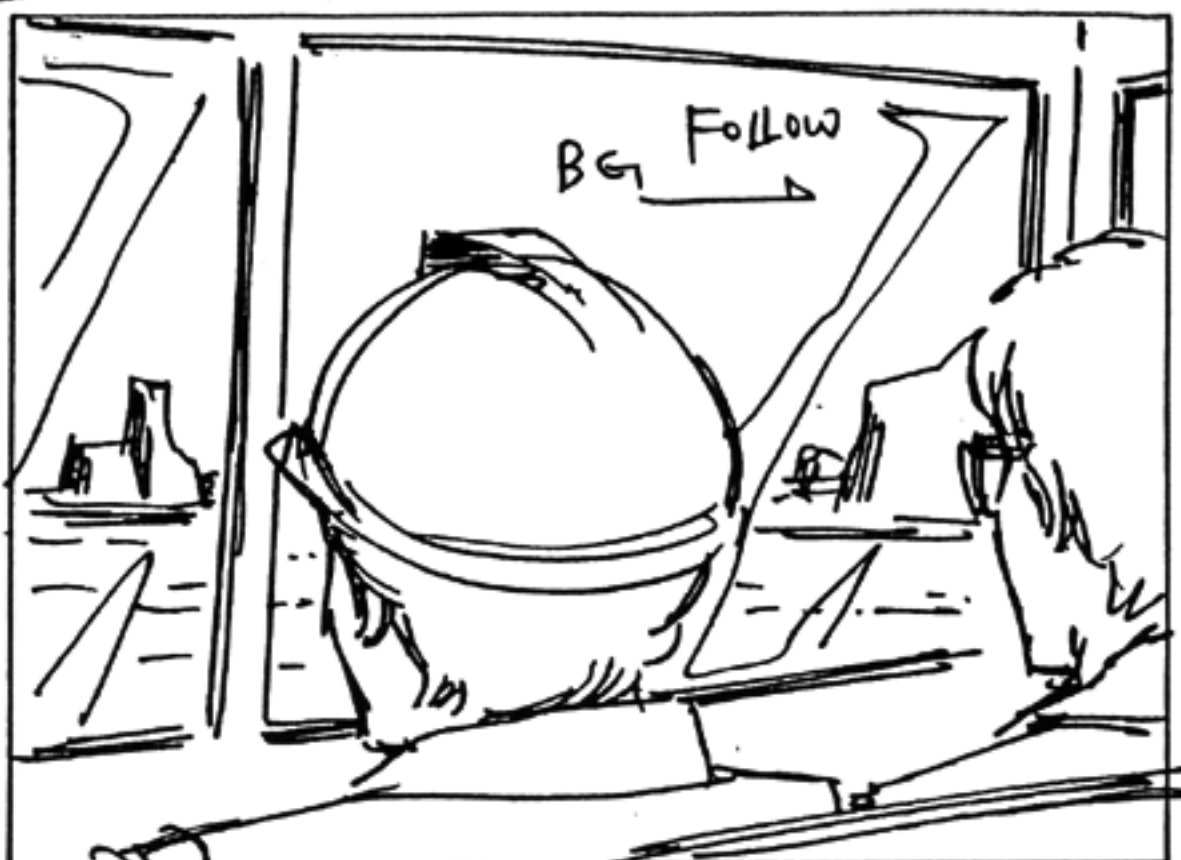

C.U. OPTS PRIME'S WINDSHIELD.  
PRIME: I WILL DO MY BEST NOT TO FAIL  
YOU -- THE OTHER AUTOBOTS -- OR THE EARTH.

CONT

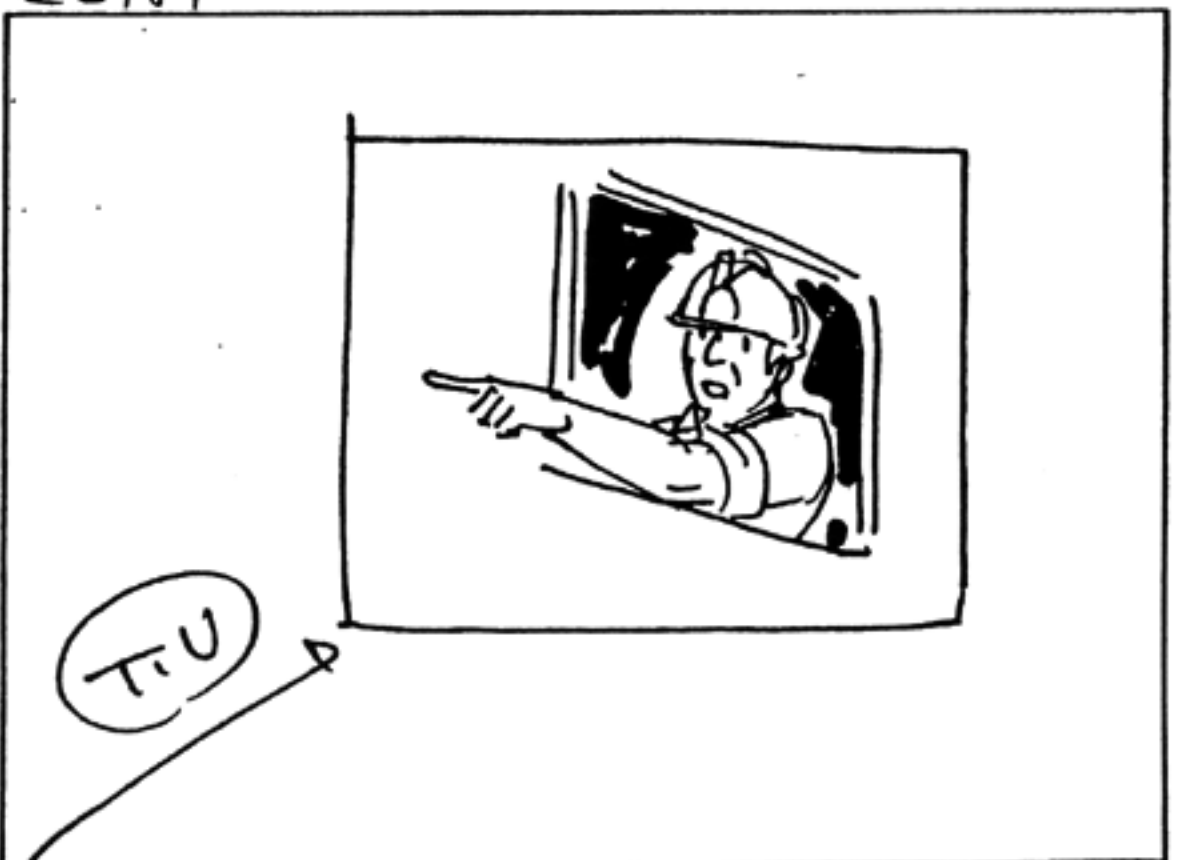

... I THINK WE'RE HERE

179

TRUCK IN

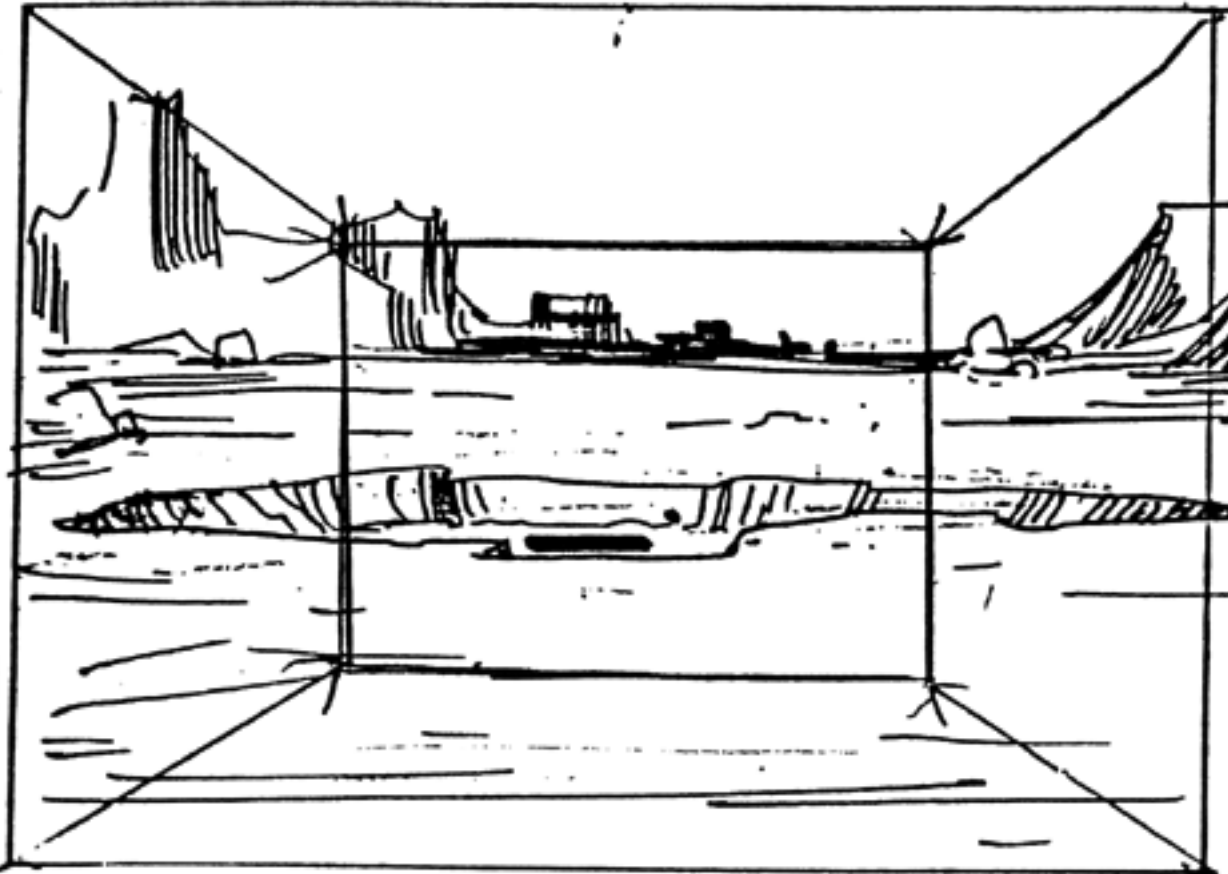

L.S. THE ROCKY BASIN

180

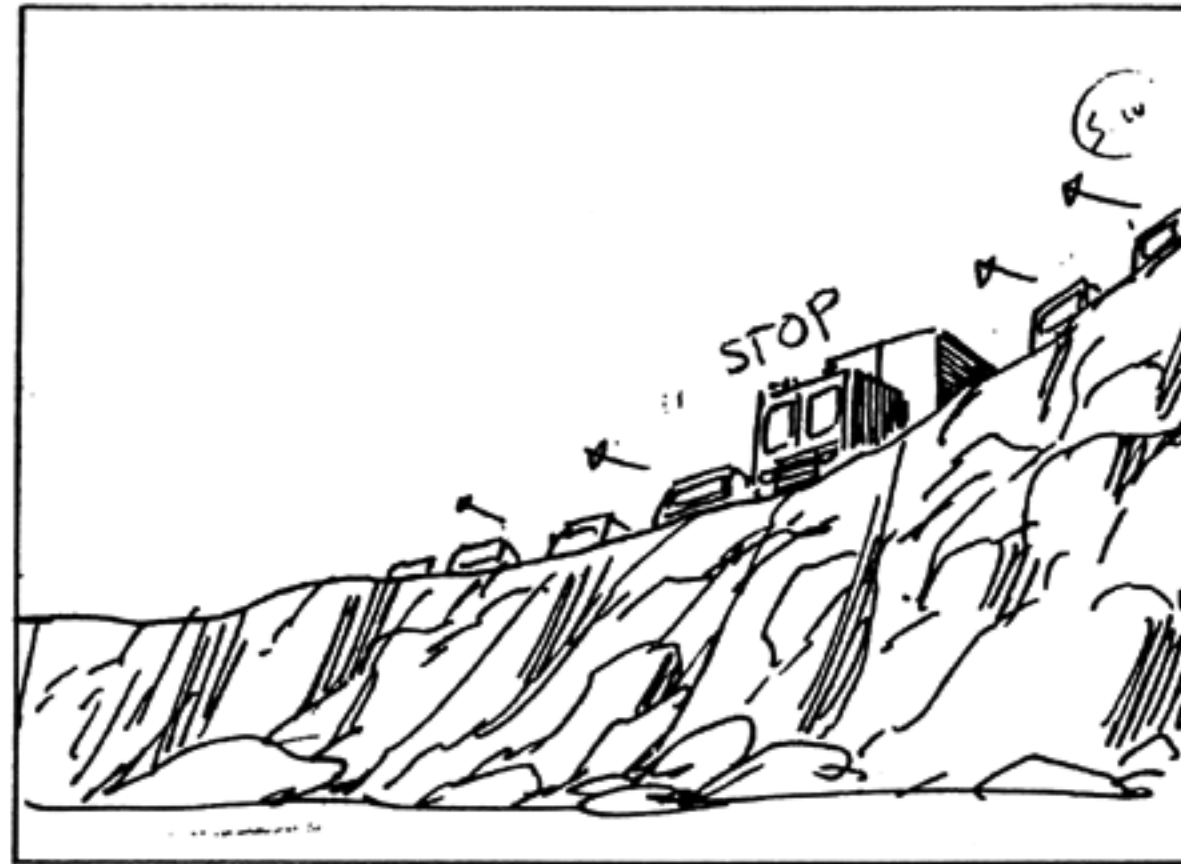

L.S. THE AUTOBOTS DRIVE IN AND COME TO A STOP NEAR THE EDGE OF THE BASIN. PRIME! AUTOBOTS ... TRANSFORM!

CONT

700-13

57

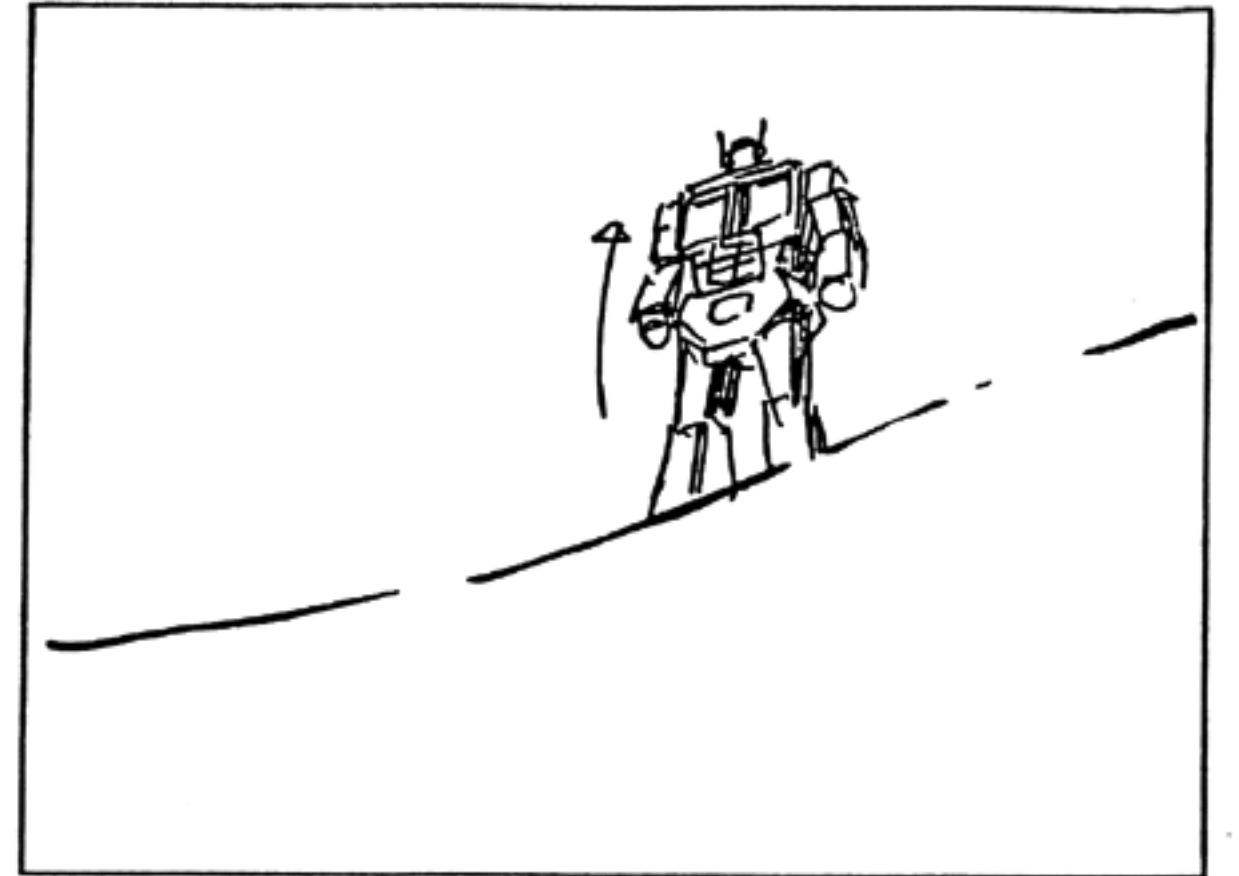

PRIME TRANSFORMS!

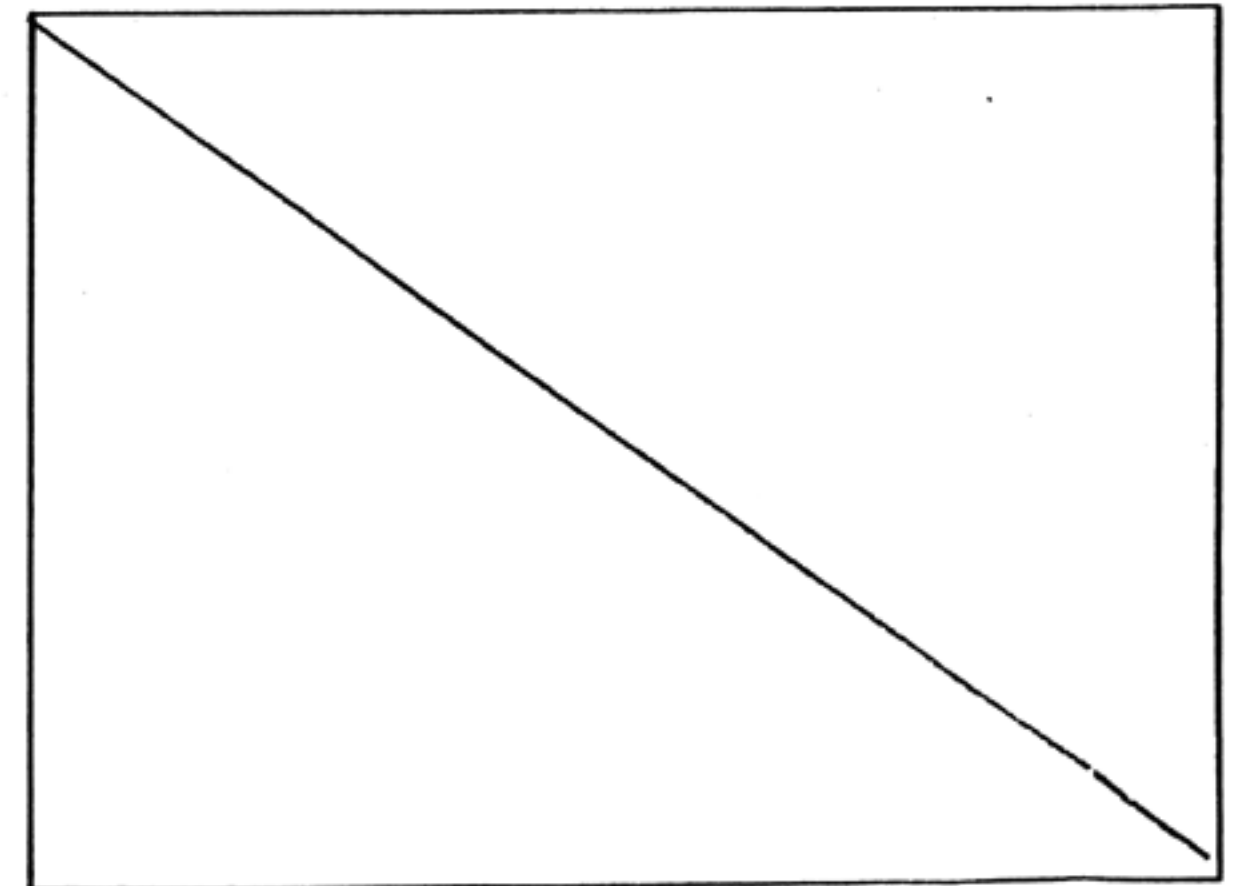
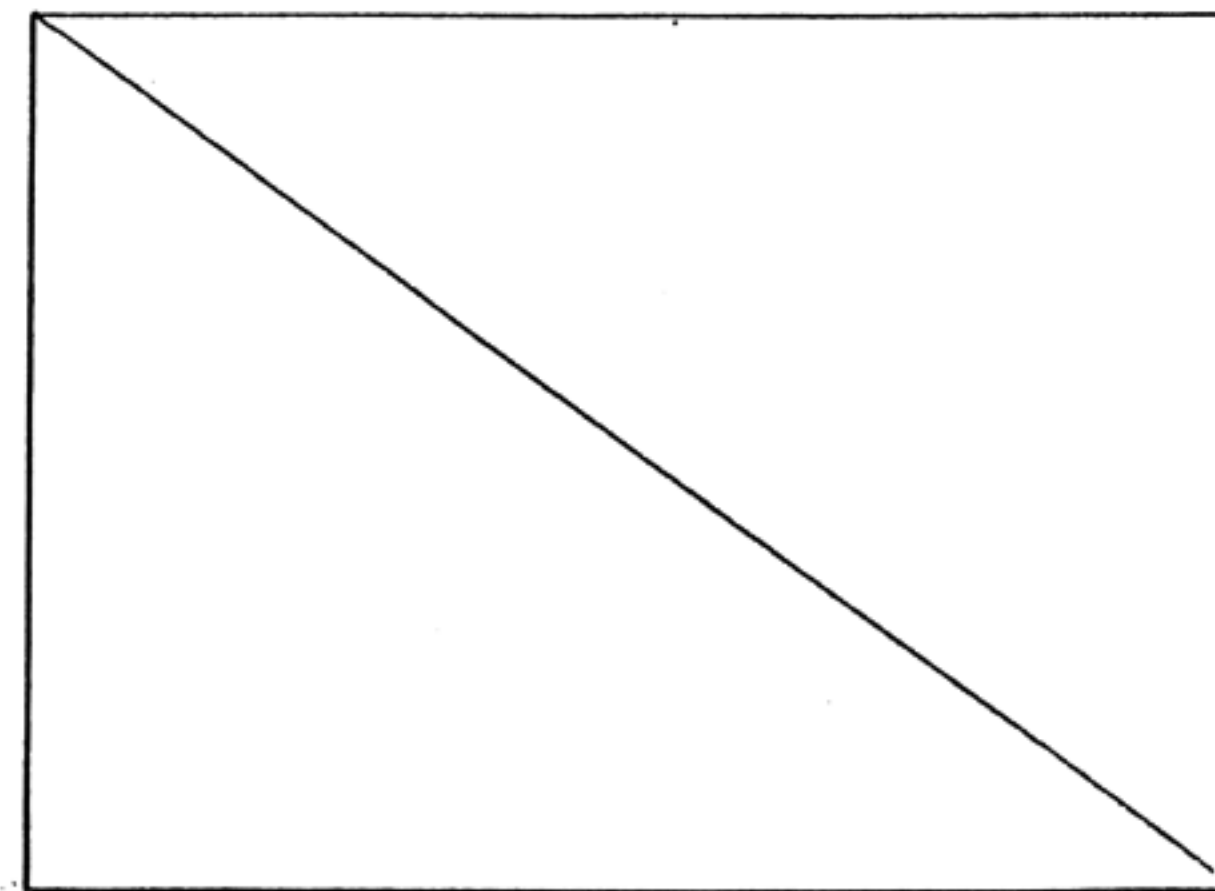
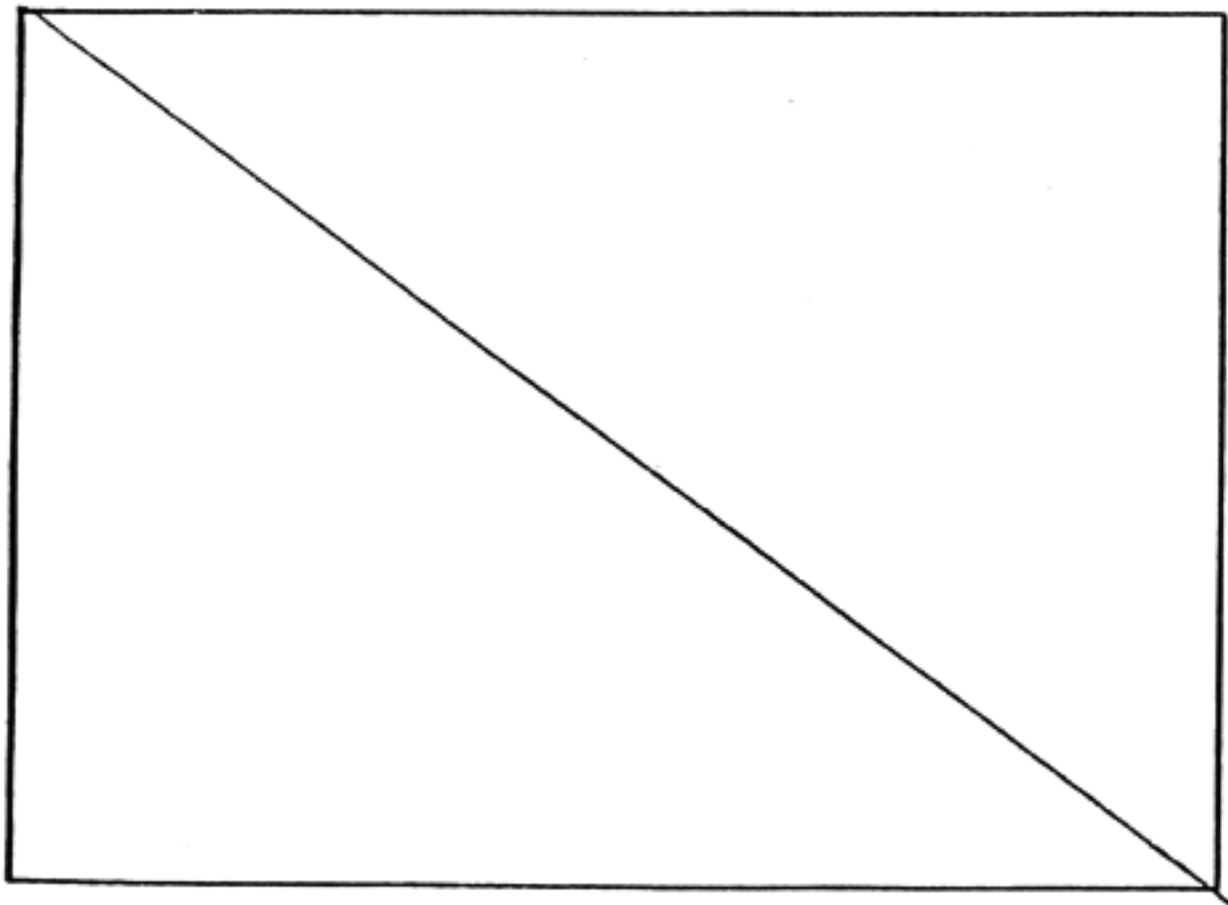

182

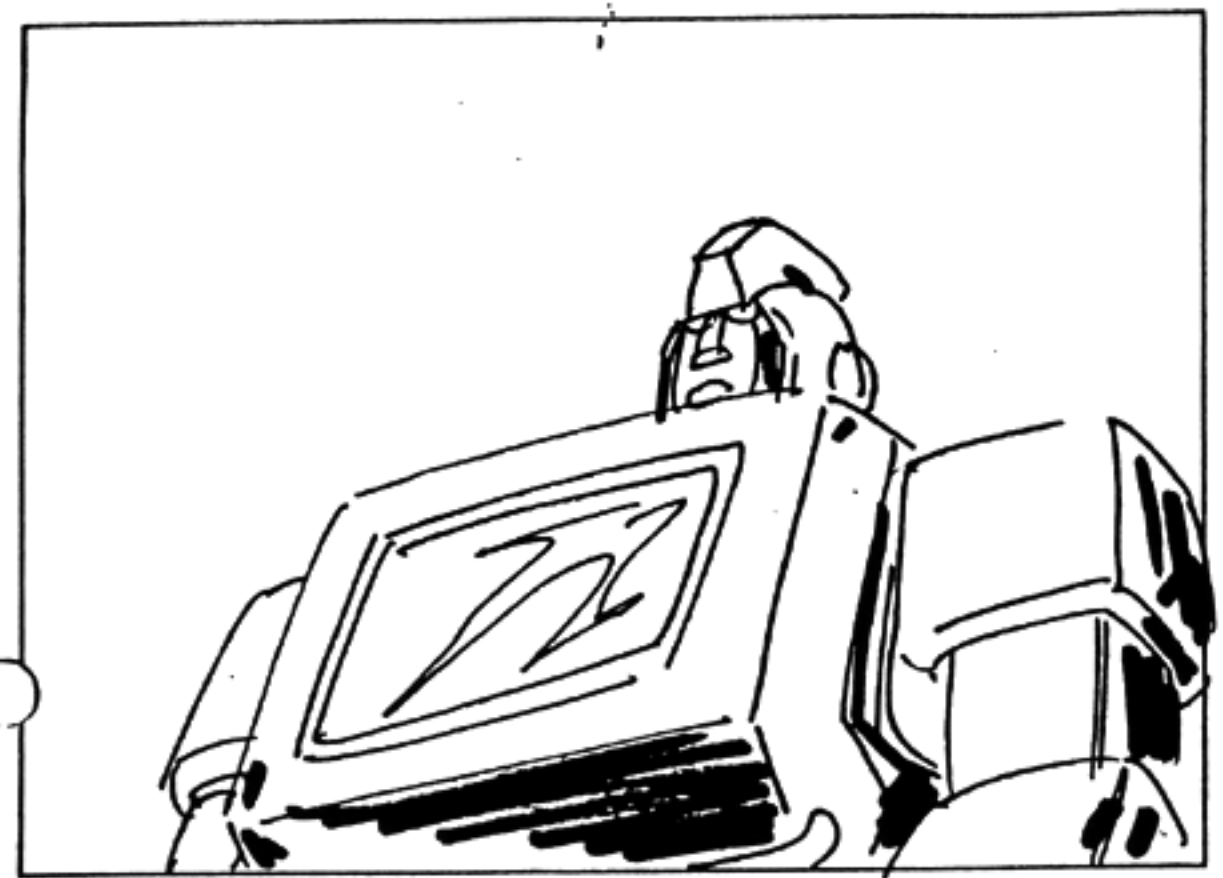

M.C.U. IRONHIDE  
IRONHIDE OKAY WERE HERE ...

183



M.S. CHIP, SPIKE, AUTOBOTS B.G  
CHIP: THAT ANSWER YOUR QUESTION  
IRONHIDE

181

START

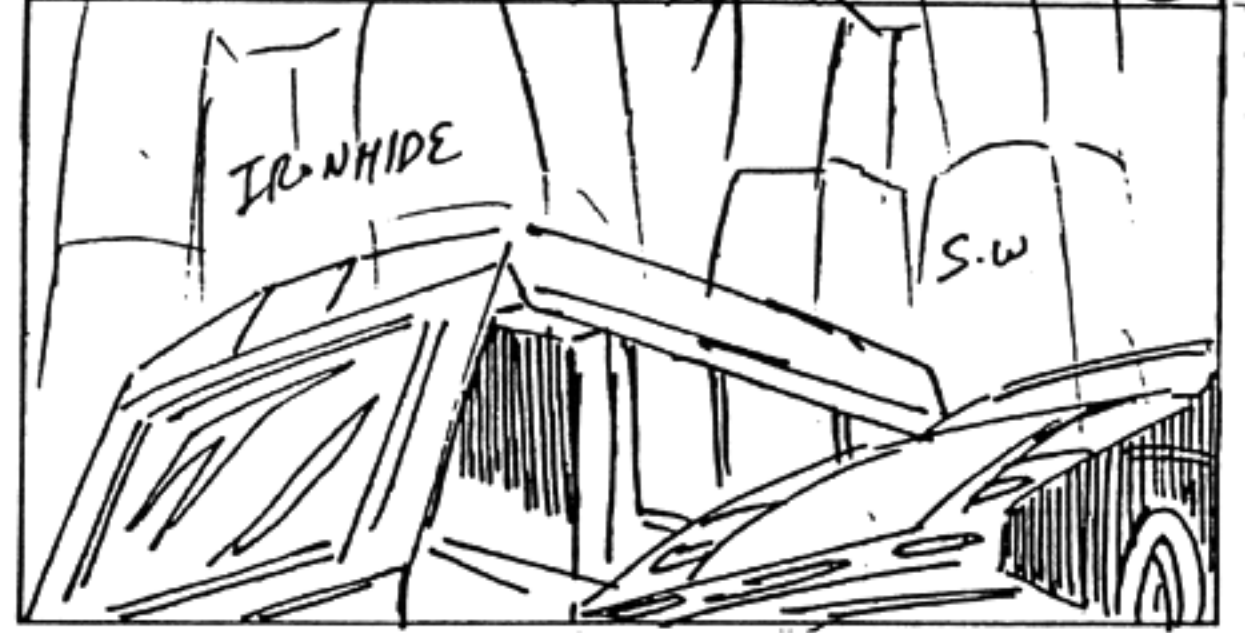
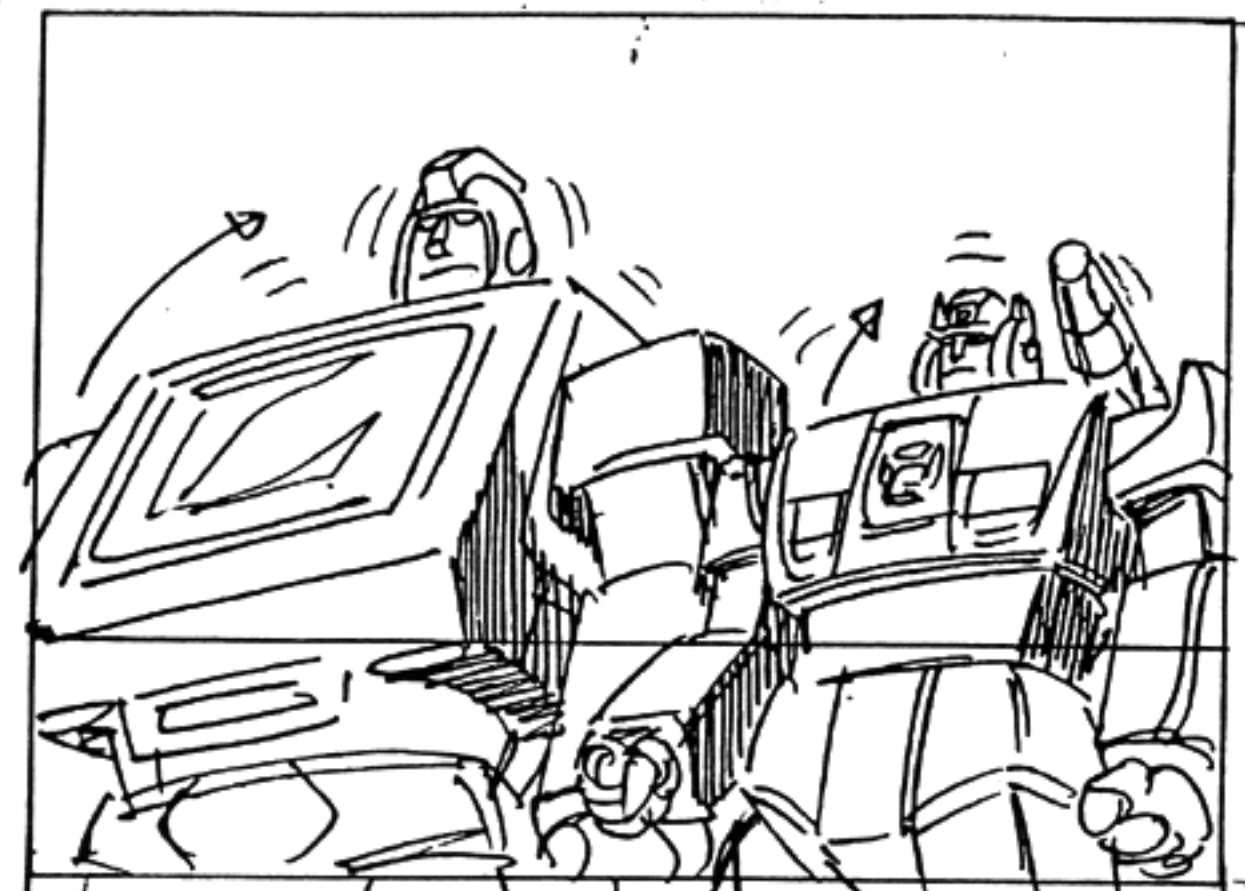

M.S. THE AUTOBOTS TRANSFORM!  
IRONHIDE & SIDESWIPE FOLLOWED  
BY ...

PAN →

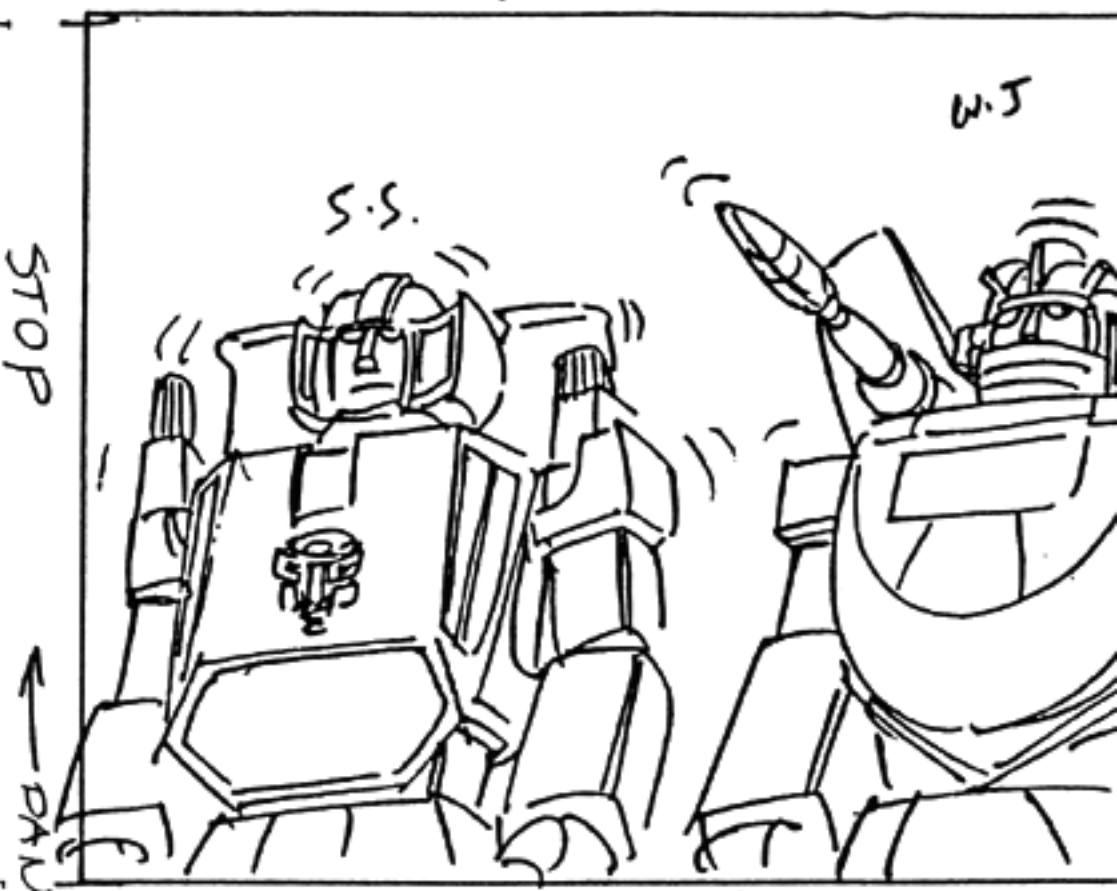

... SUNSTREAKER & WHEELJACK

STOP  
PAN ←  
START

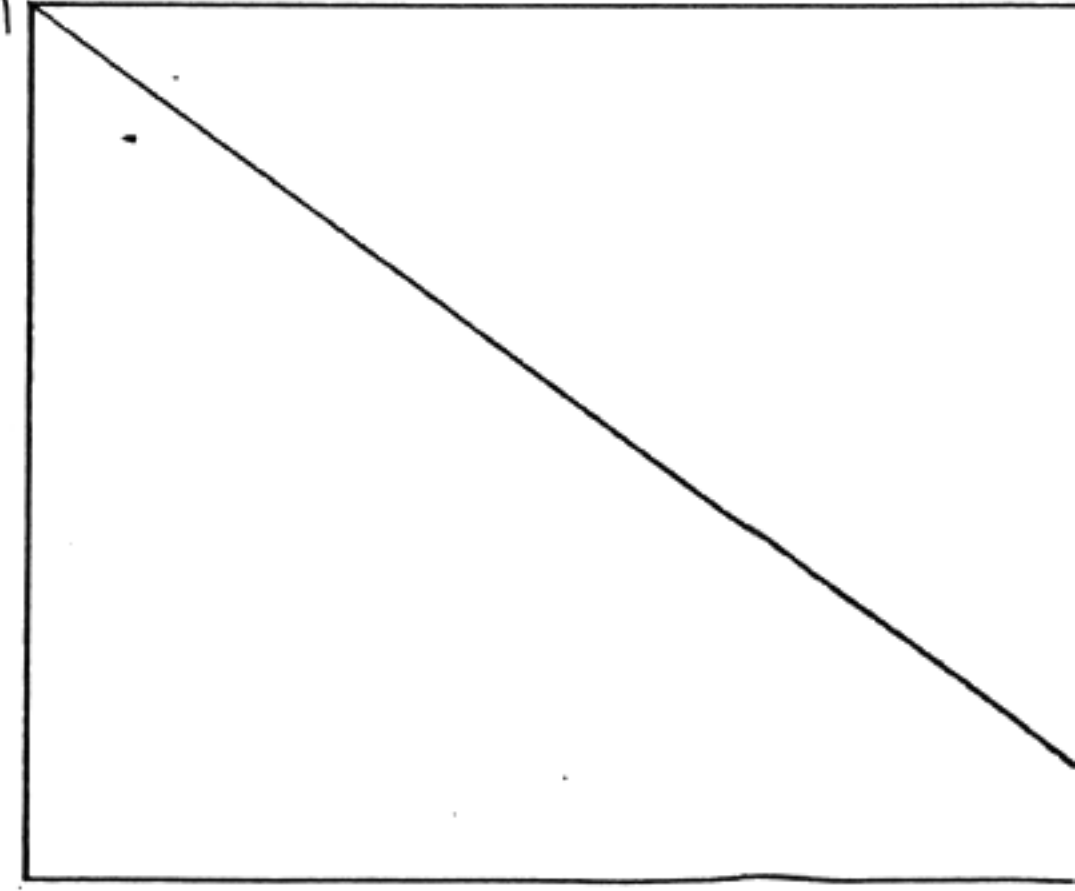

184



X.L.S DECEPTICONS.

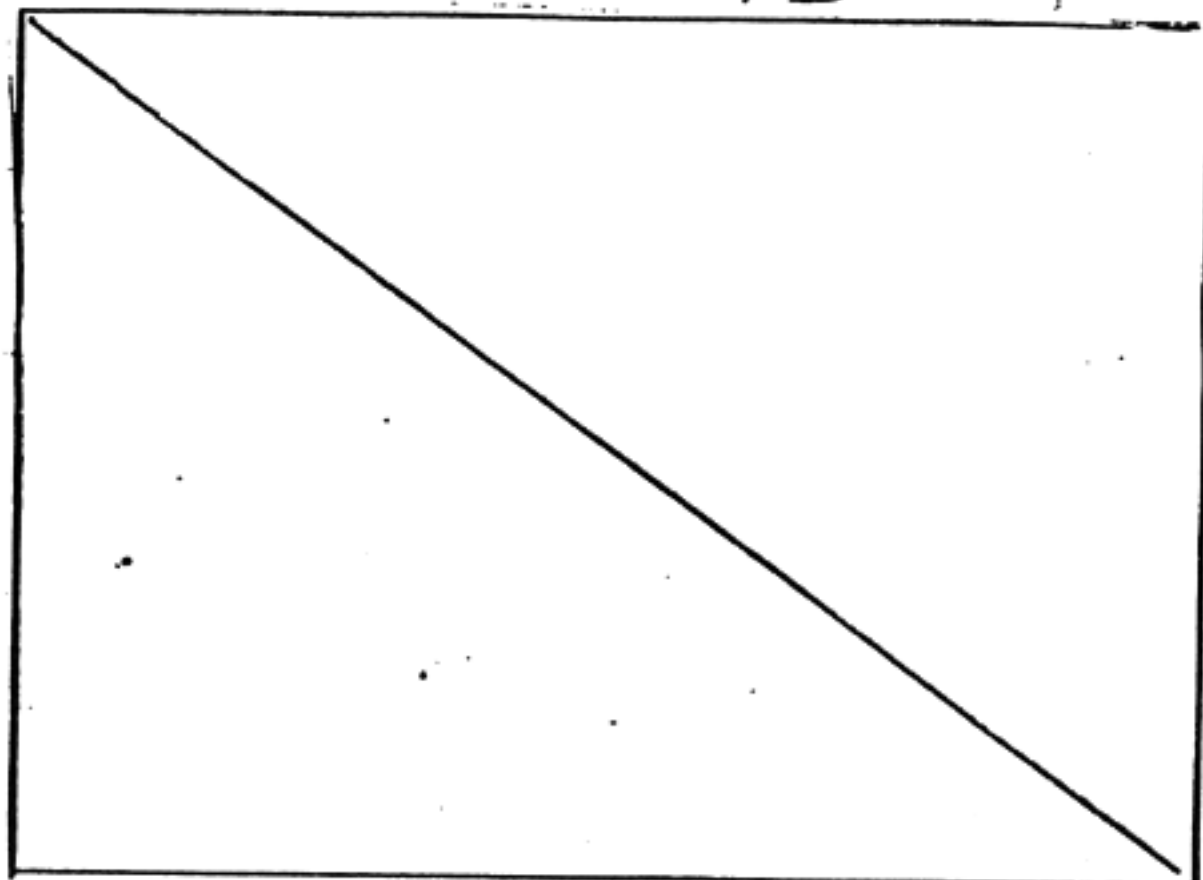
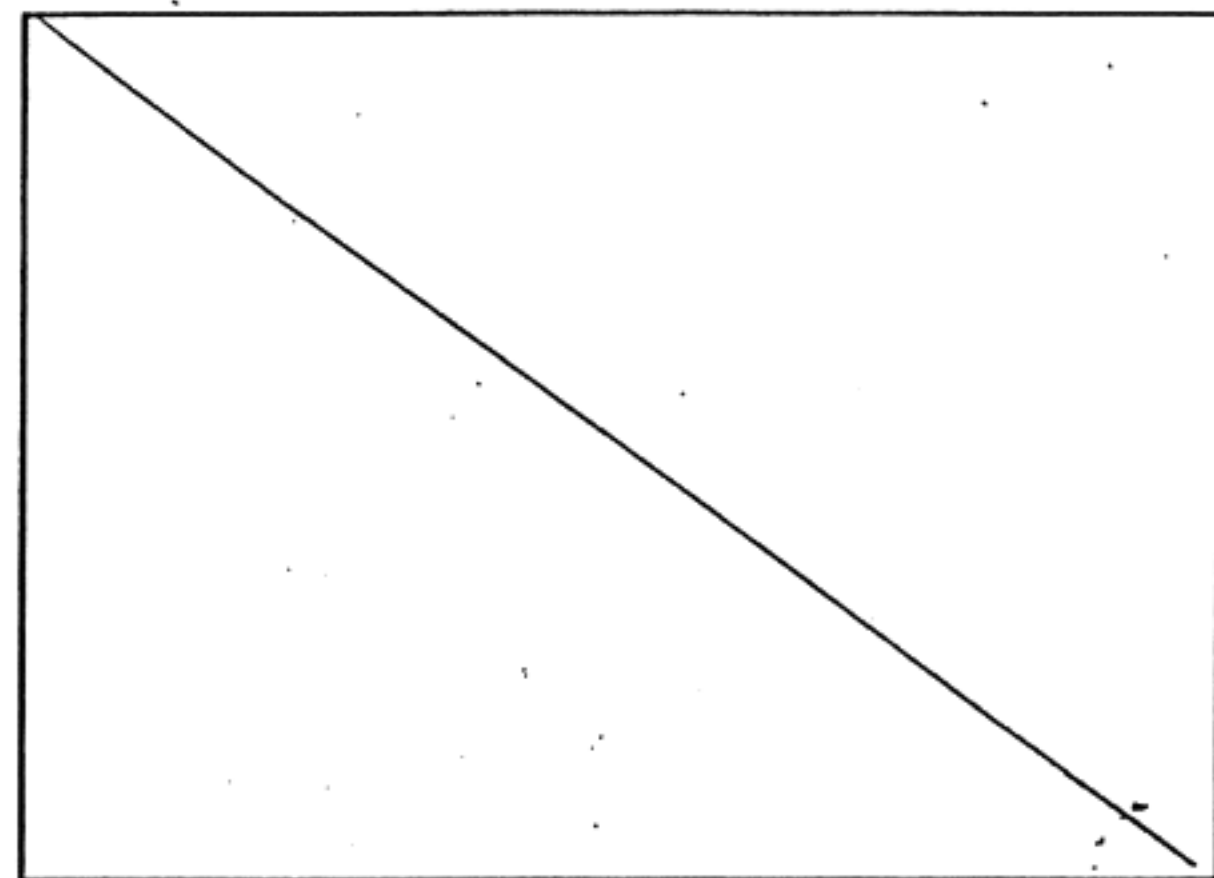

185

B.G. PAN

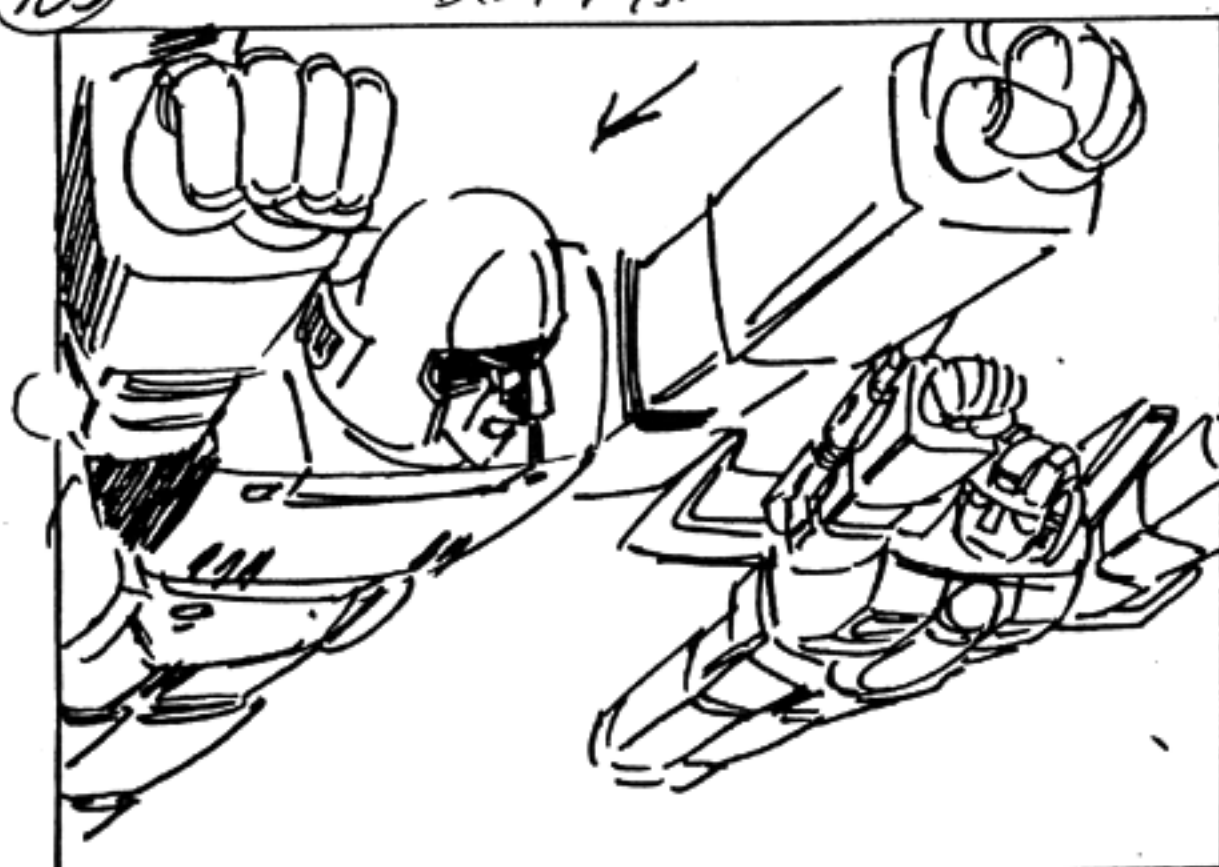

M.S. MEGATRON & STARSCREAM  
STARSCREAM: WITHOUT OUR POWER CHIP RECTIFIERS WE'RE LUCKY WE CAN STILL FLY, MEGATRON.  
MEGATRON: I WOULDN'T WANT YOU WALKING TO THE SHOW THAT MIGHT TIP OUR HANDS.

186

PAN BG

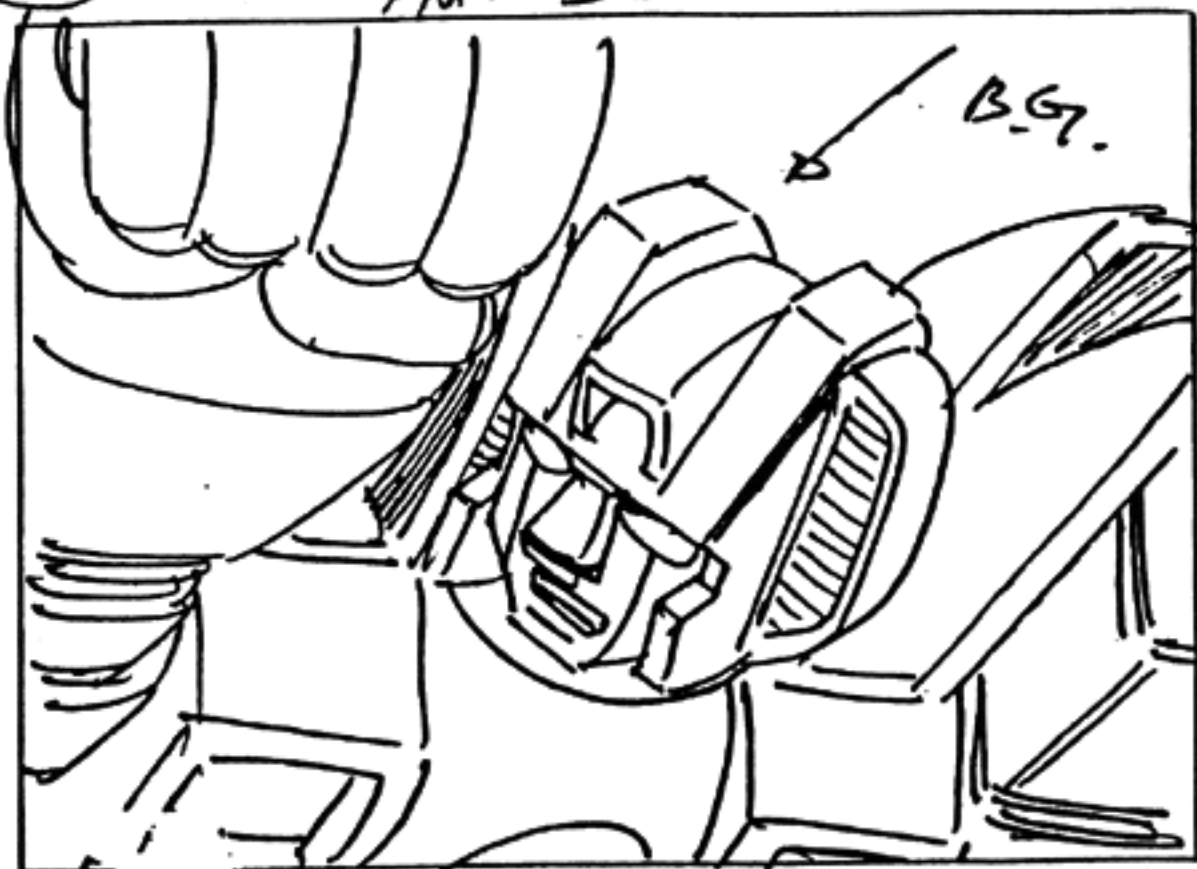

C.U. STARSCREAM.  
STARSCREAM: YOU WILL REMEMBER TO RETURN OUR CHIPS ONCE YOU'VE USED THEM AGAINST OPTIMUS PRIME, WON'T YOU?

187

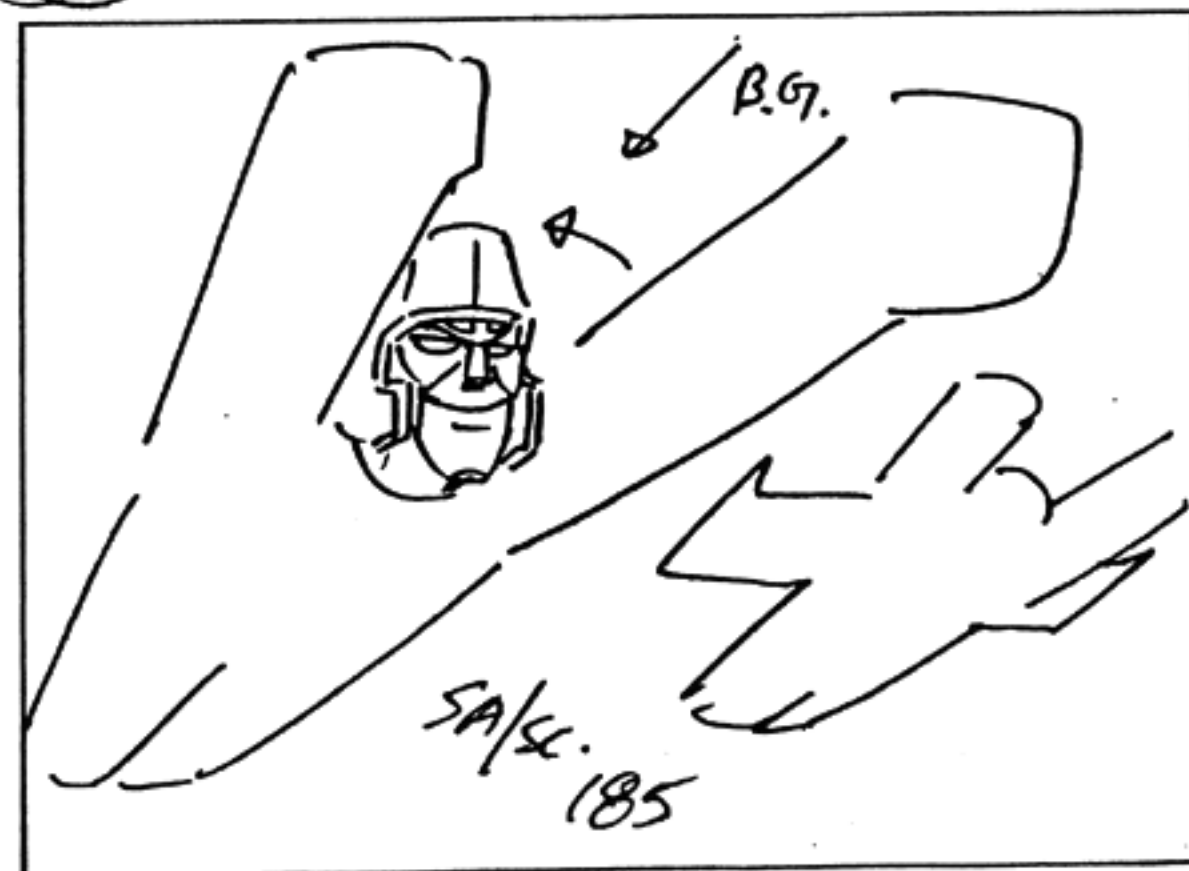

M.S. MEGATRON & STARSCREAM  
MEGATRON SMILES.

188

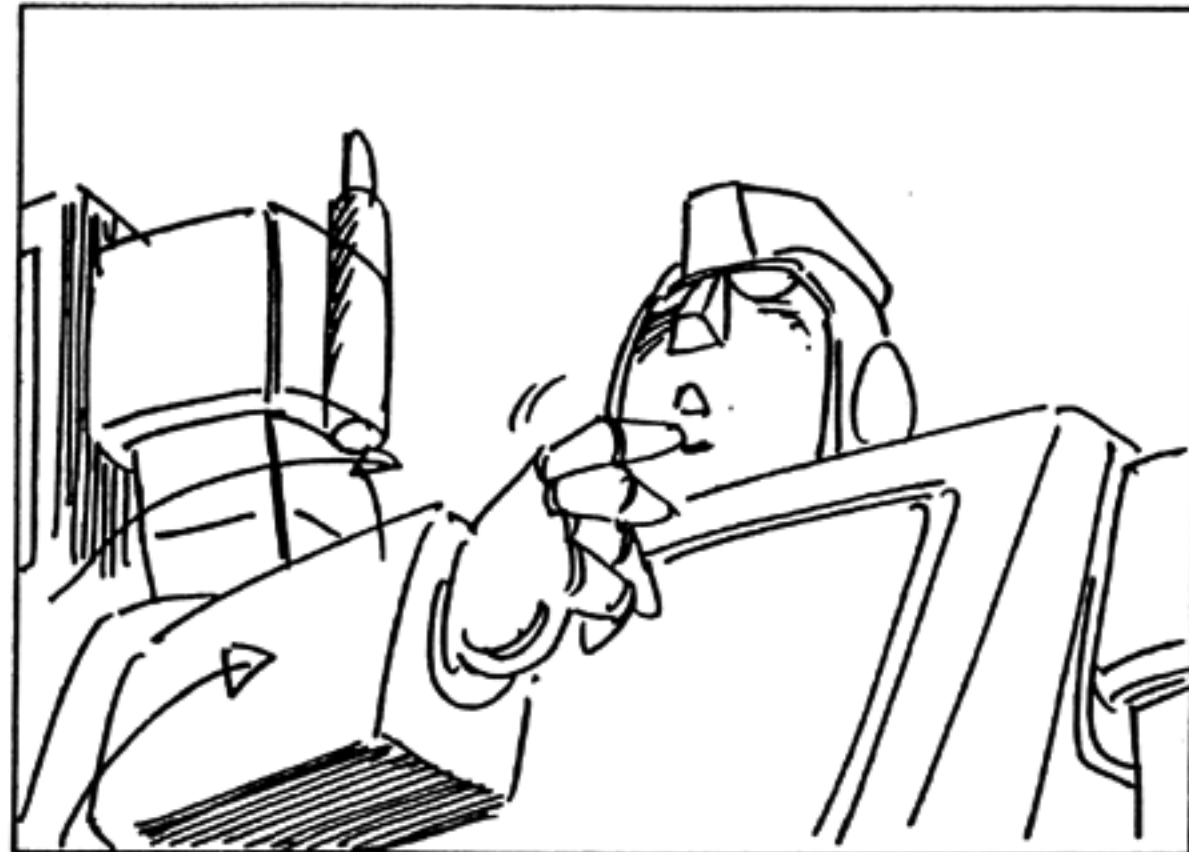
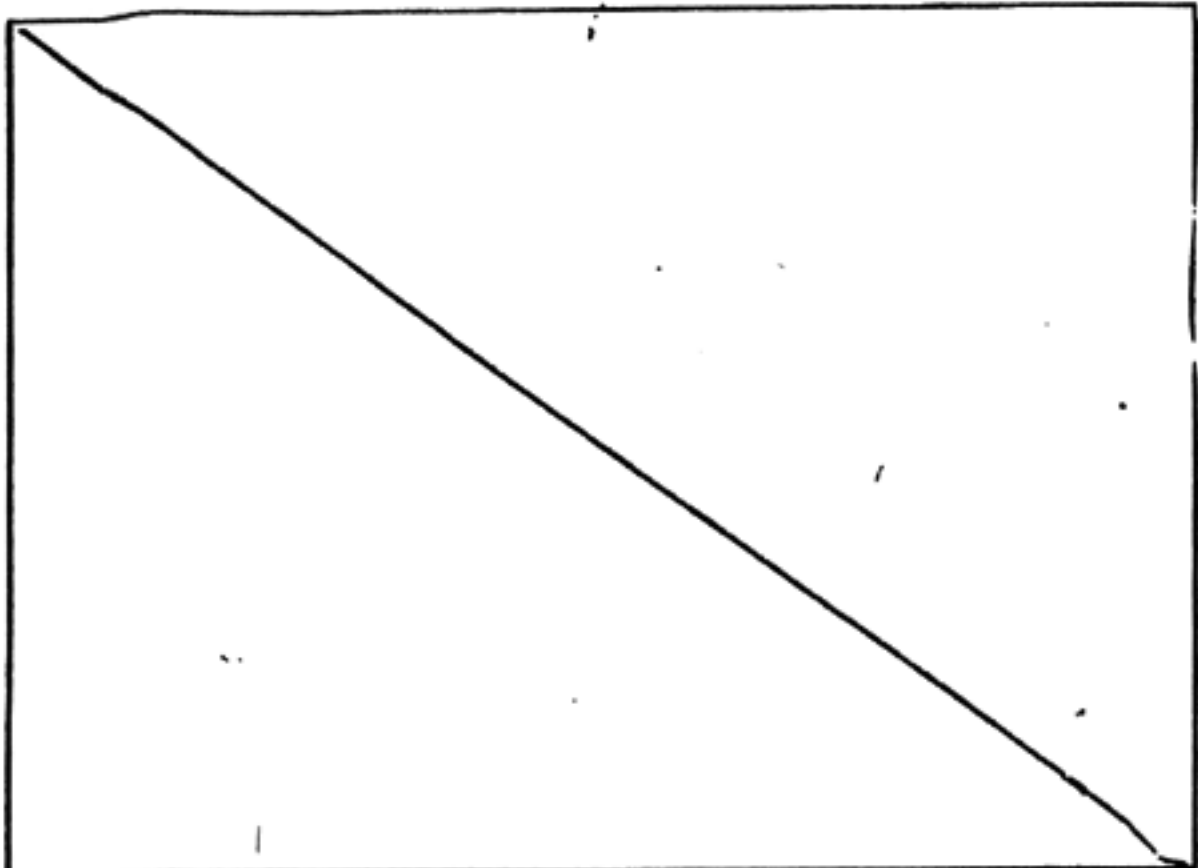

M.C.U. IRONHIDE  
IRONHIDE: STRANGE... SOME OF THOSE CRUMBS  
USUALLY LIKE TO SHOW OFF BY CHANGING  
TO THEIR JET PLANE MODES.

189

700-13

62

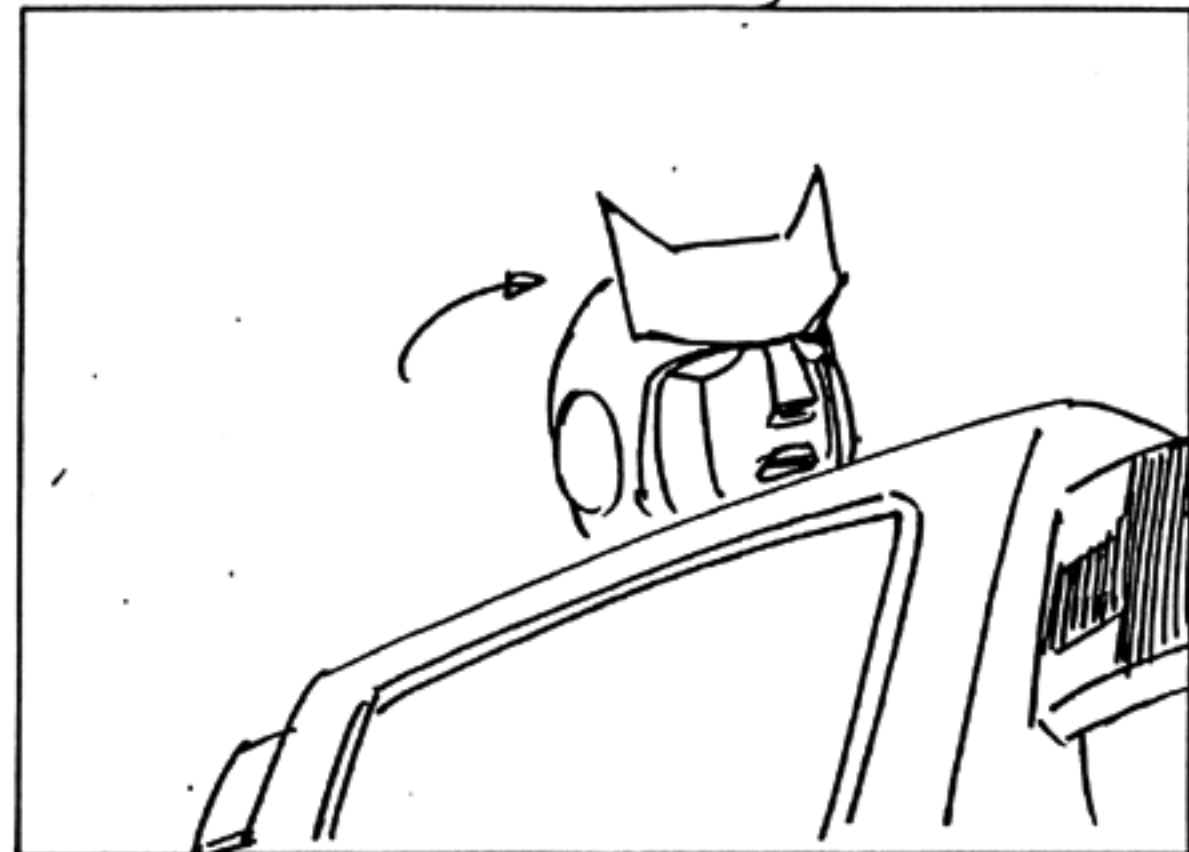

M.C.U. RATCHET  
RATCHET: NO BIGGIE, IRONHIDE. THEY PROBABLY  
DON'T WANT TO TAKE THE SPOT LIGHT AWAY  
FROM MEGATRON.

190

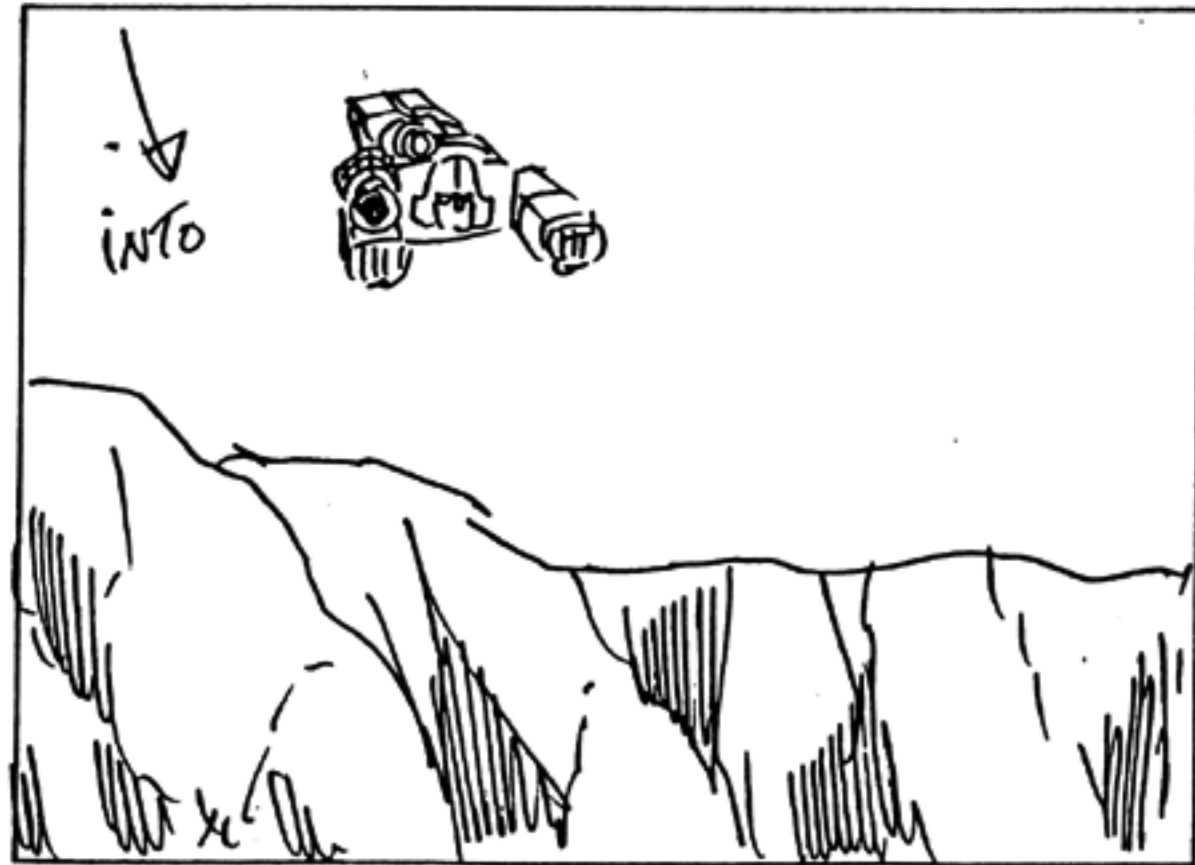
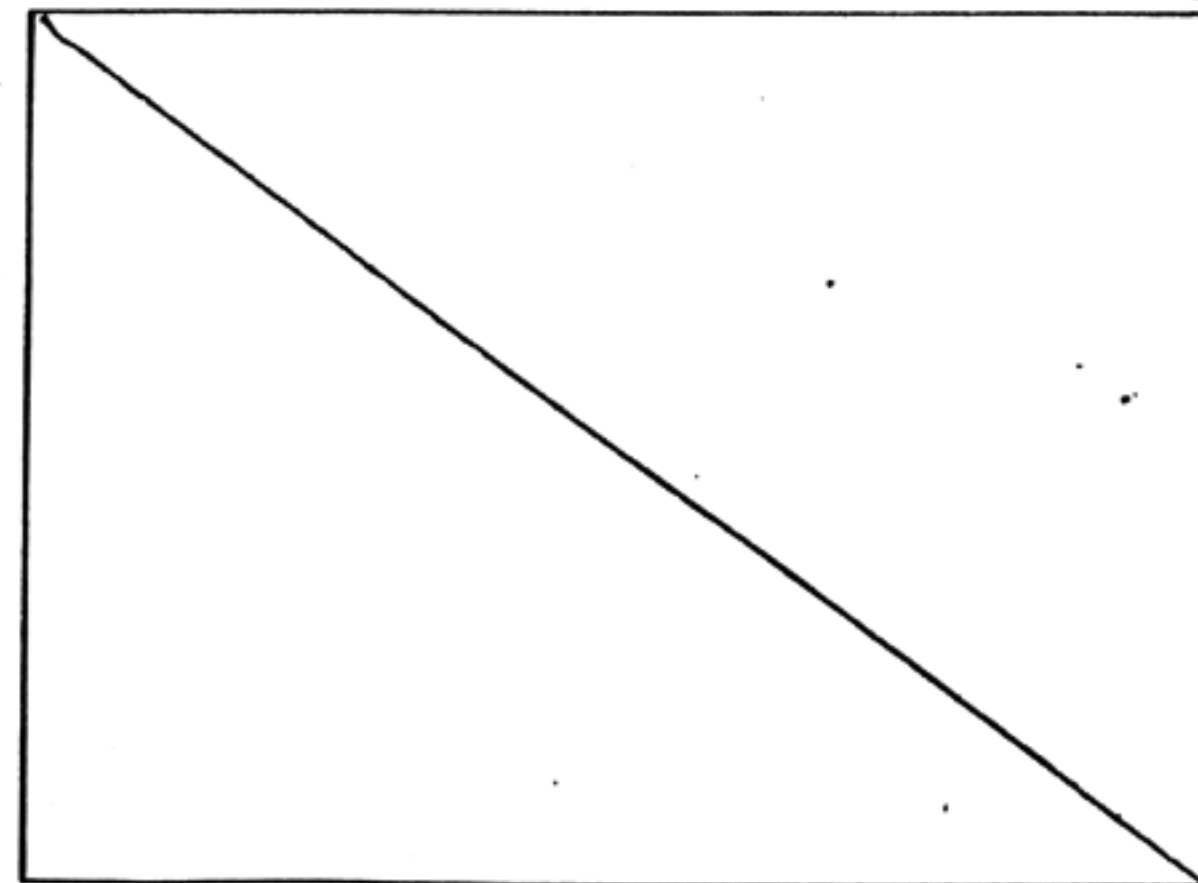

L.S.: MEGATRON & STARSCREAM. THEY  
COME IN FOR A LANDING.

CONT

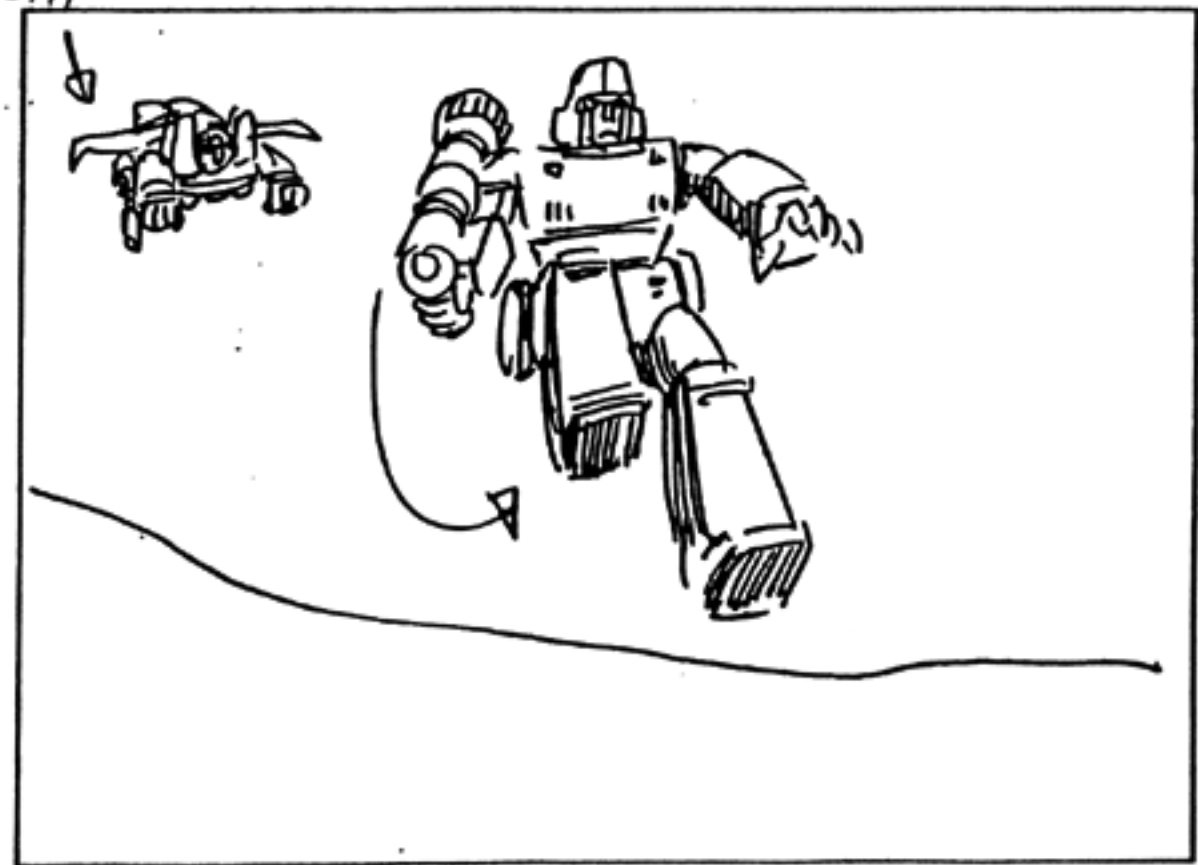

MEGATRON PROUDLY LANDS ON EDGE OF ROCKY  
BASIN

CONT 190

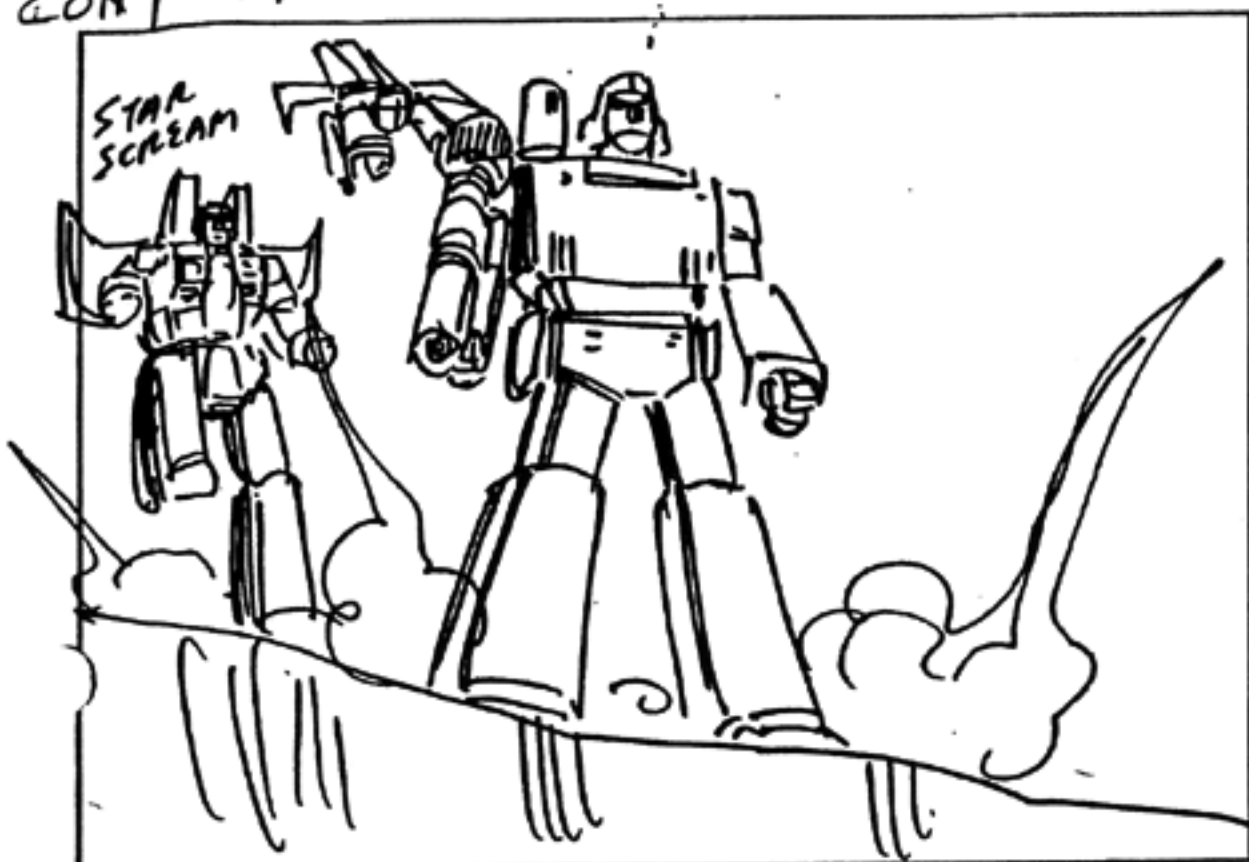

FOLLOWED BY THE OTHER DECEPTICONS WHO KEEP BEHIND HIM.

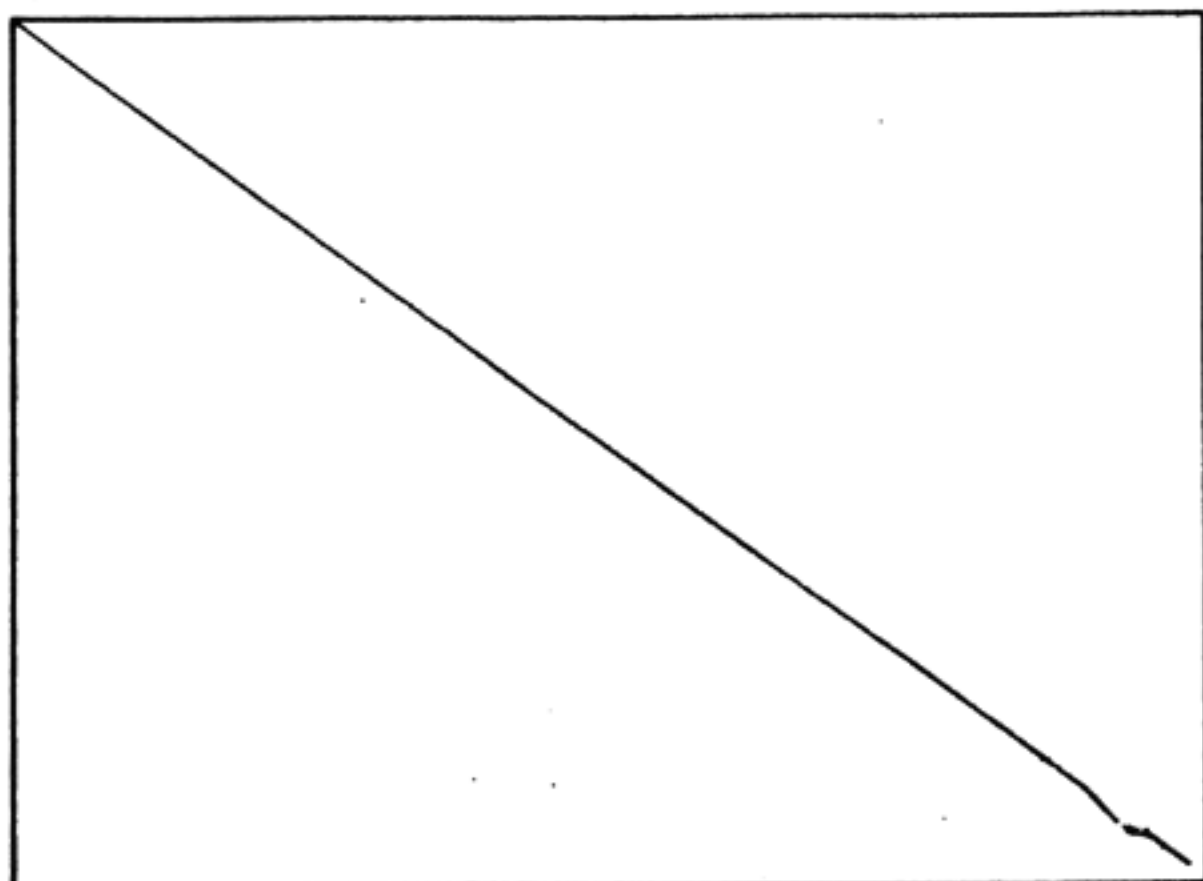

191

700-13

63



C.U. MEGATRON  
MEGATRON: HAIL, OPTIMUS PRIME... AND WELCOME TO DEFEAT!

192

START

PAN →

STOP

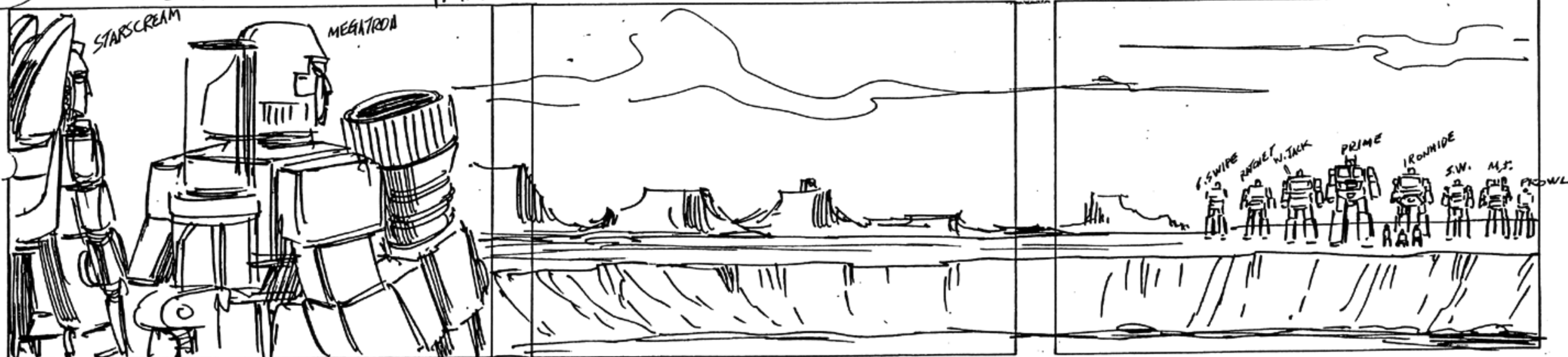

M.S. MEGATRON & STARScream, PAN TO L.S. AUTOBOTS

OPTIMUS PRIME: DEFEAT, MEGATRON? IT SEEMS TO ME OUR BATTLE HAS NOT YET BEGUN!

193



C.U. MEGATRON

CONT

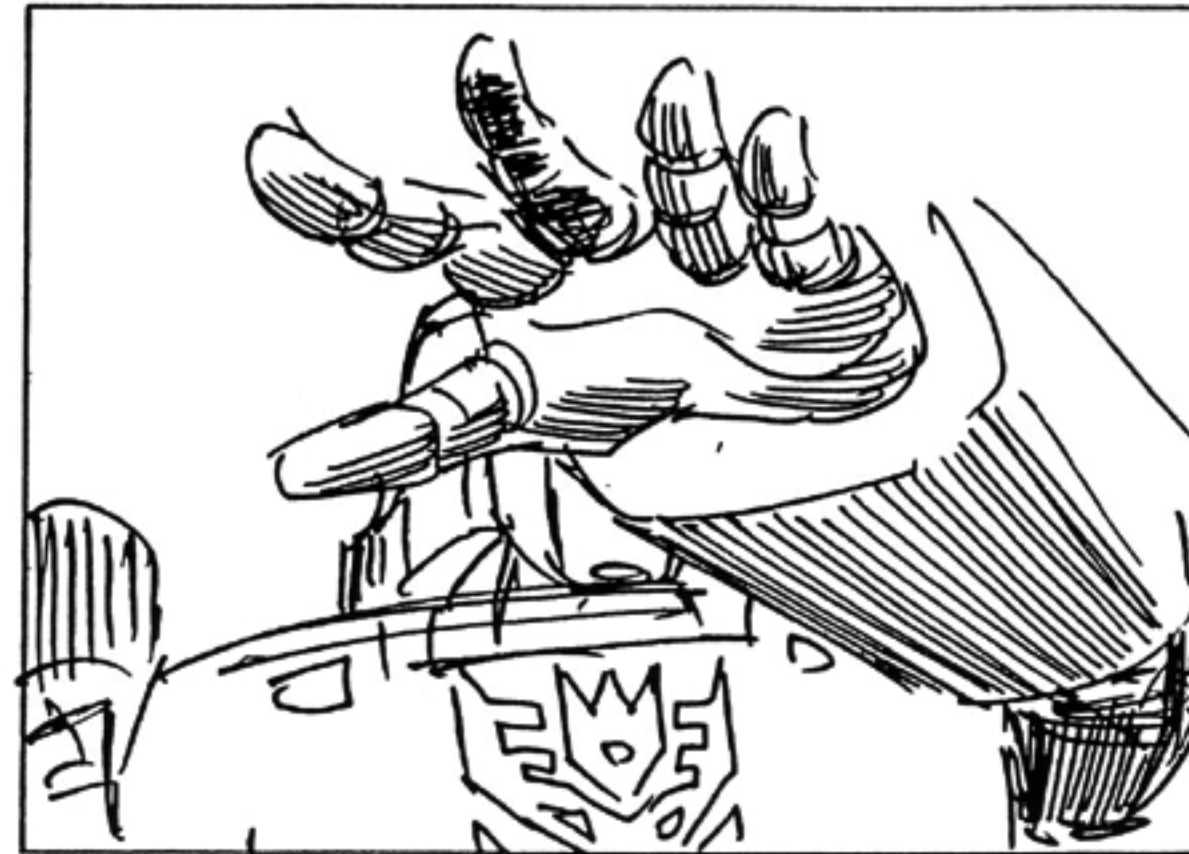

CONT

700-13

64



MEGATRON: AS SOON AS OUR RESPECTIVE ARMIES TAKE THEIR PLACES ...

WE SHALL CORRECT THAT SMALL OVERSIGHT.

194

START

PAN →

STOP

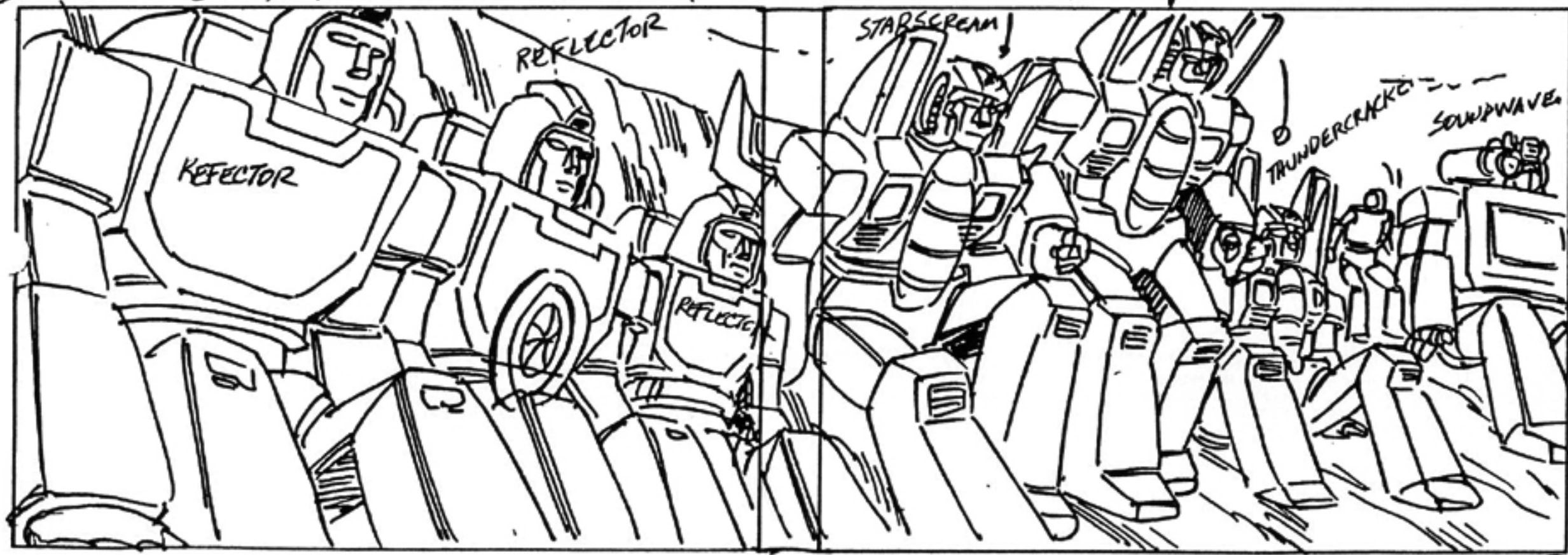

AS THE DECEPTICONS TAKE THEIR PLACES ON THE SIDE OF THE BASIN.

195



C.U. OPTIMUS PRIME.  
PRIME: REMEMBER THE LAW, MEGATRON.  
THIS BATTLE IS BETWEEN YOU AND ME - ALONE  
AND UNARMED!

196

700-13

65

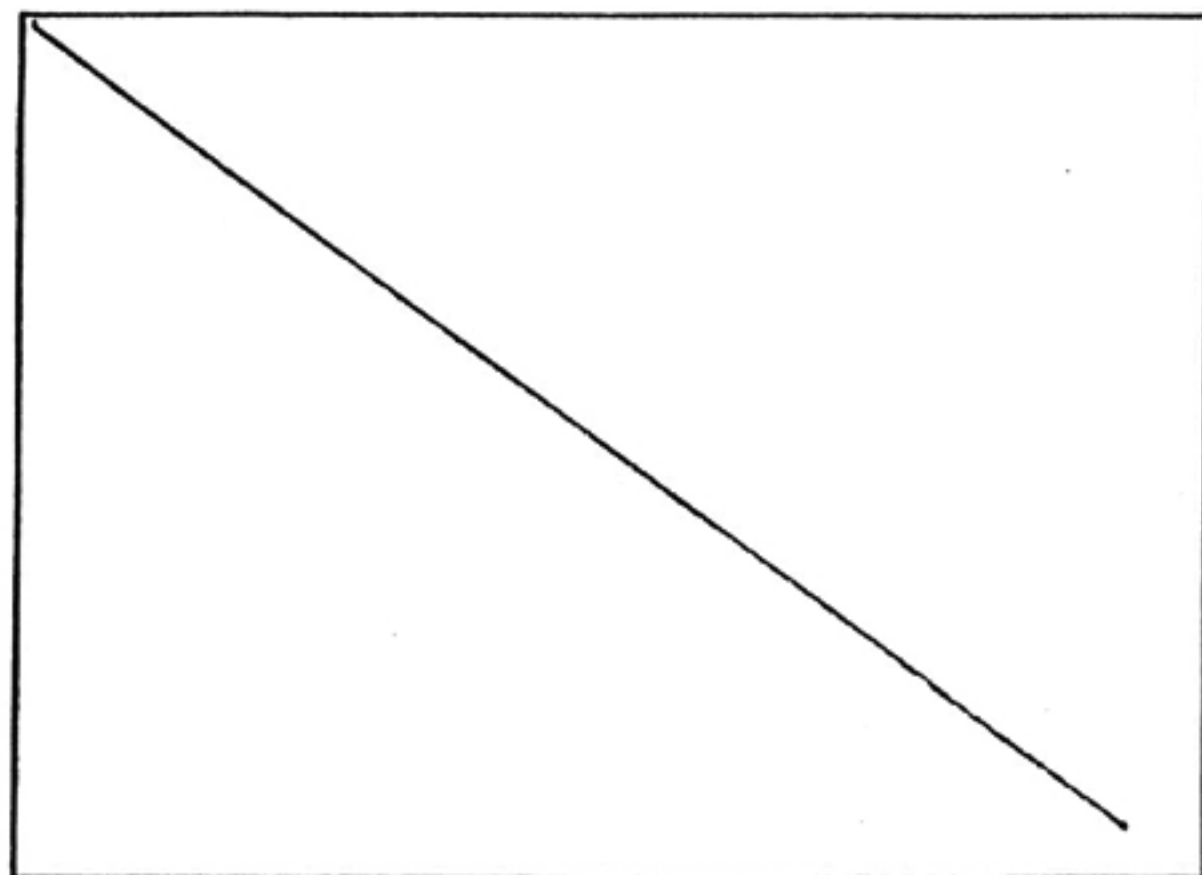
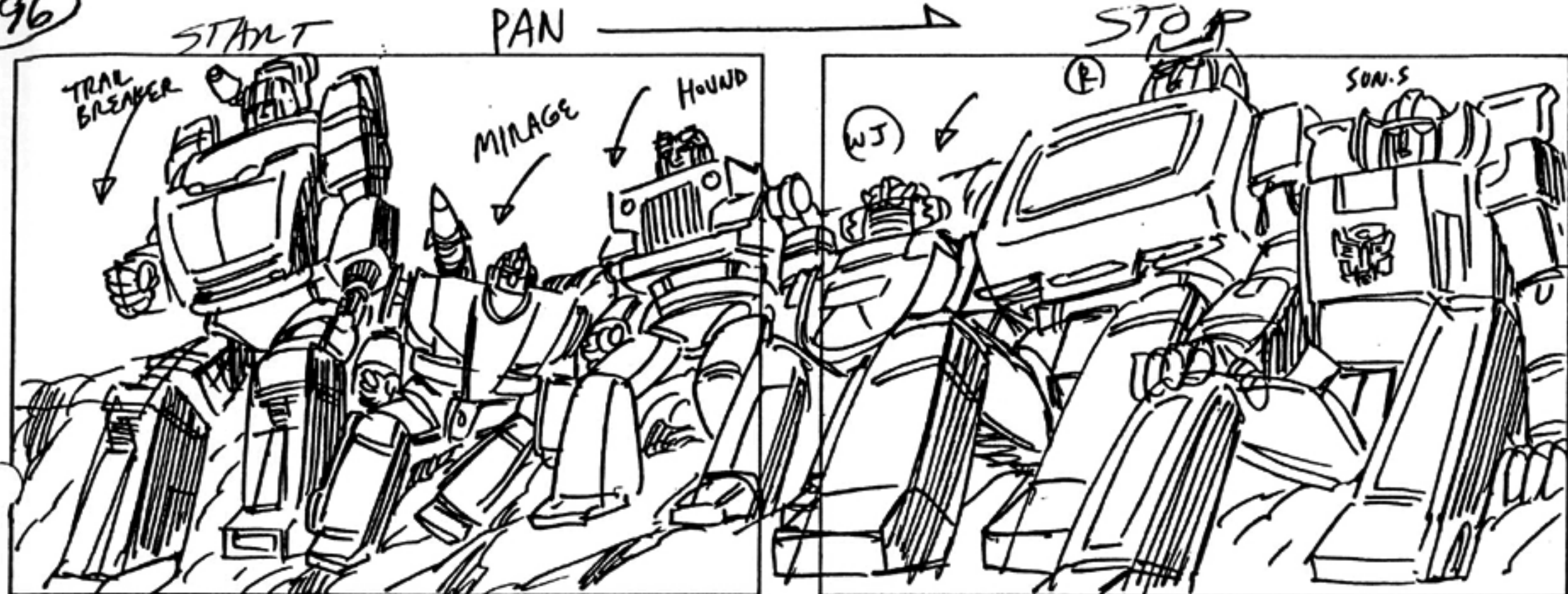

M.S. THE AUTOBOTS TAKE THEIR PLACES.

197

198

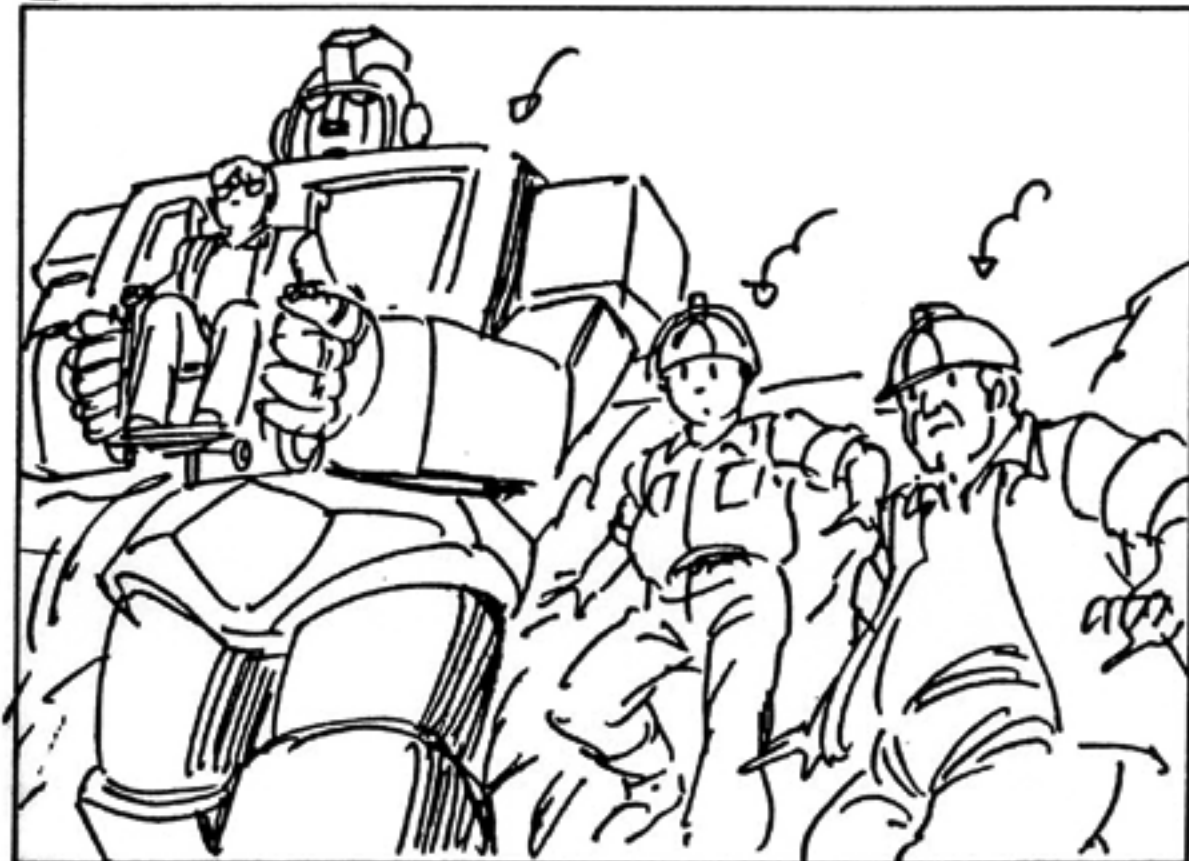
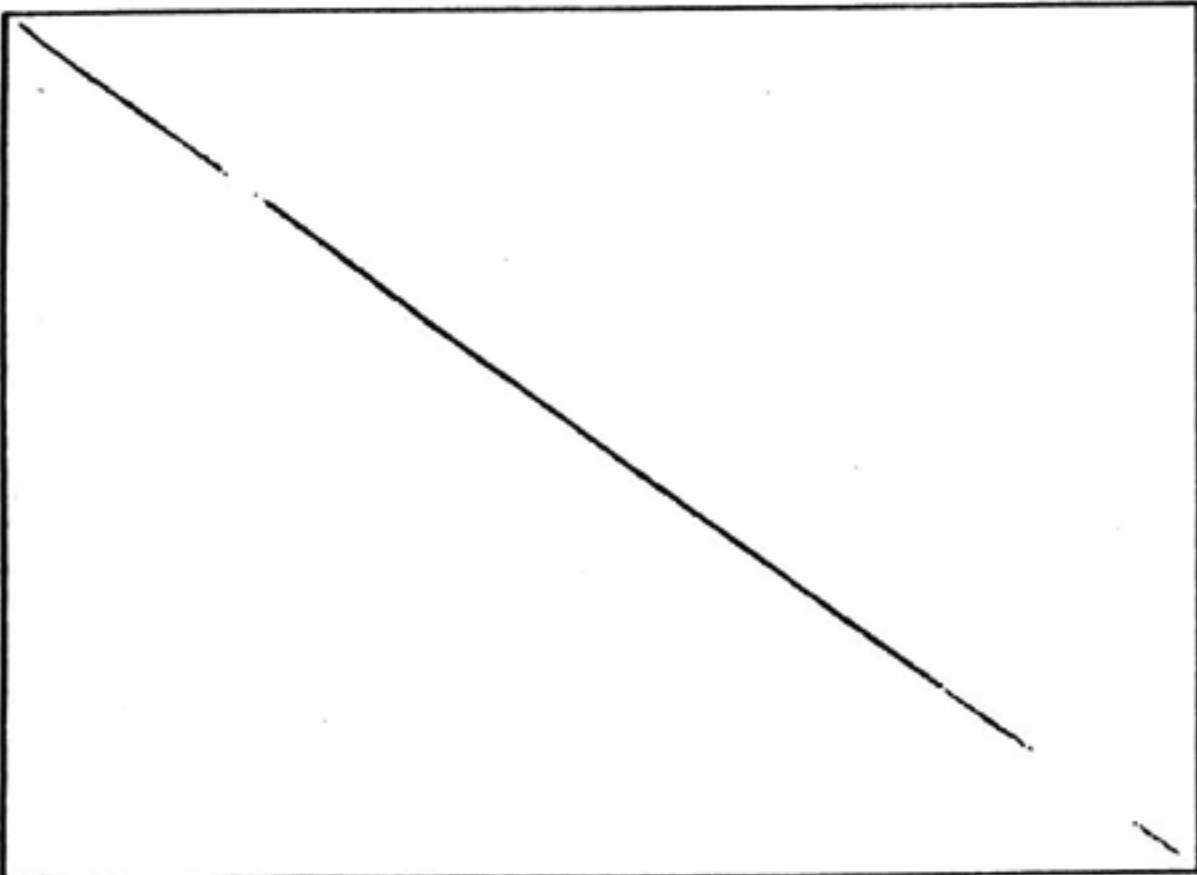

M.S. IRONINDE, CHIP SPIKE, SPARKPLUG, COMING DOWN BASIN EMBANKMENT.

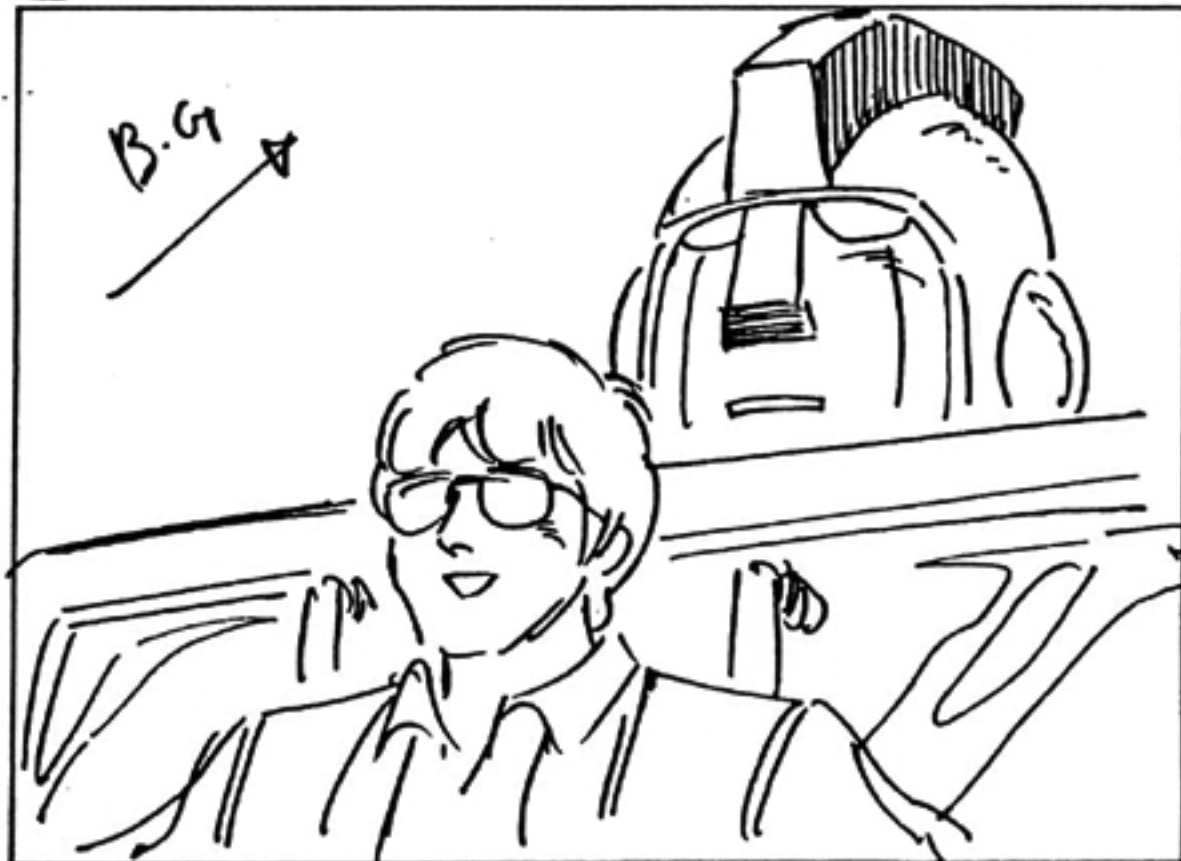

C.U. IRONINDE & CHIP.  
CHIP: DOESN'T THIS REMIND YOU OF THE GLADIATORIAL COMBAT IN ANCIENT ROME?

CONT 198



IRONHIDE: MAYBE IT WOULD IF I KNEW WHAT YOU WERE TALKING ABOUT.

SPIKE(VO) EARTH HISTORY - SKIP IT.  
CONT

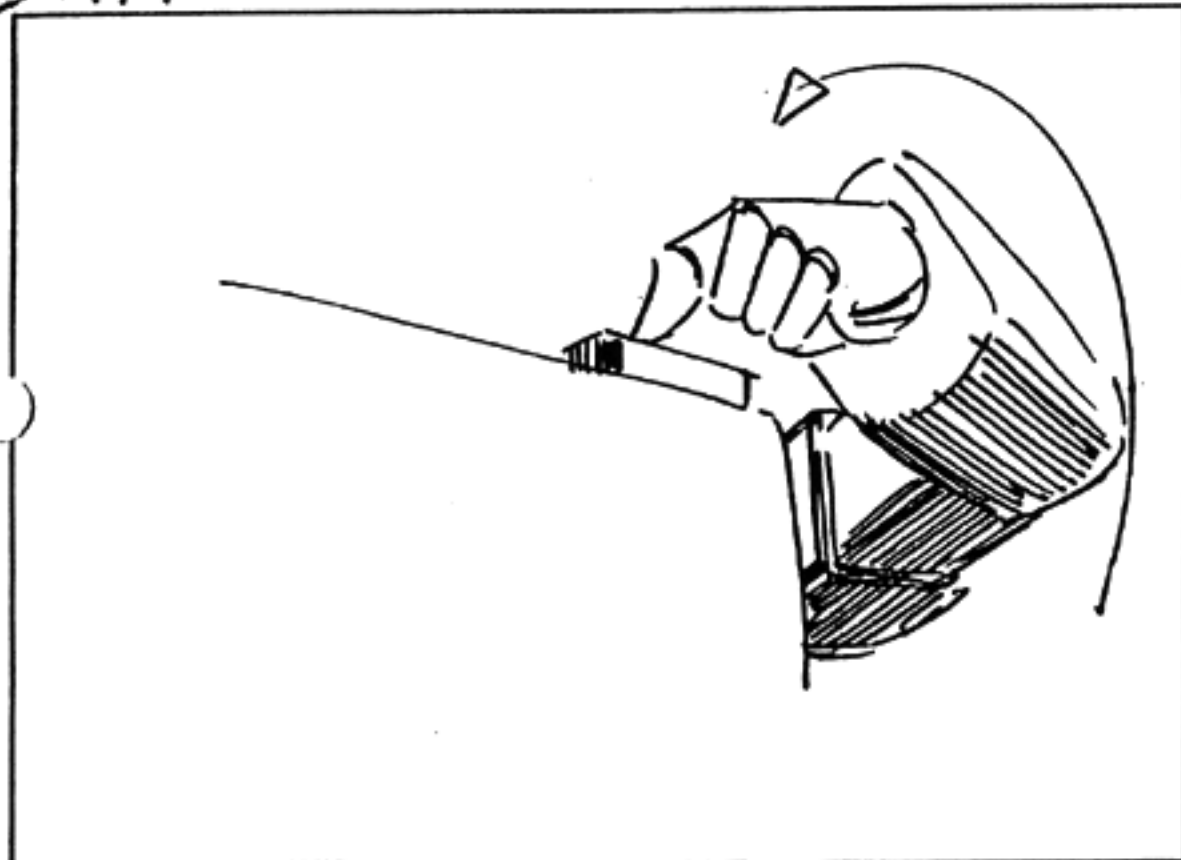

HE PUSHES THE EJECT BUTTON ...

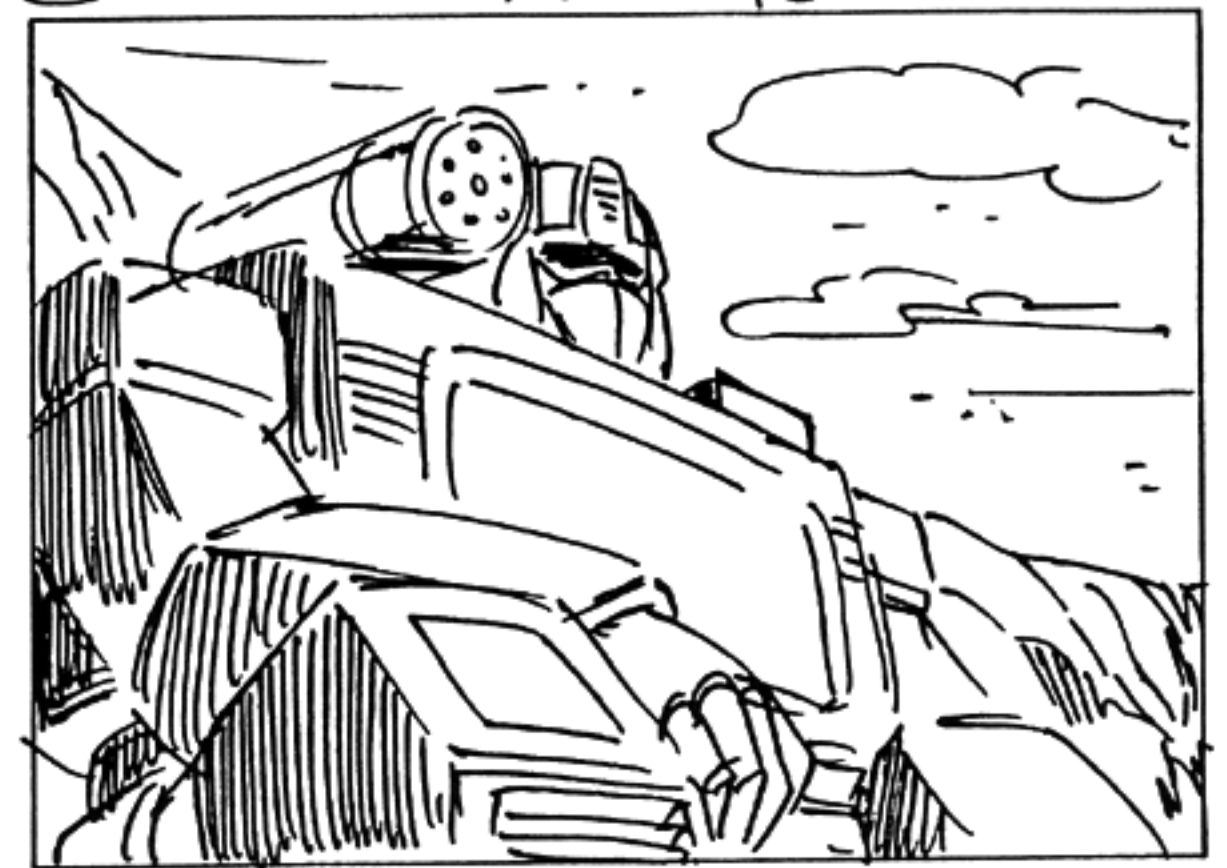
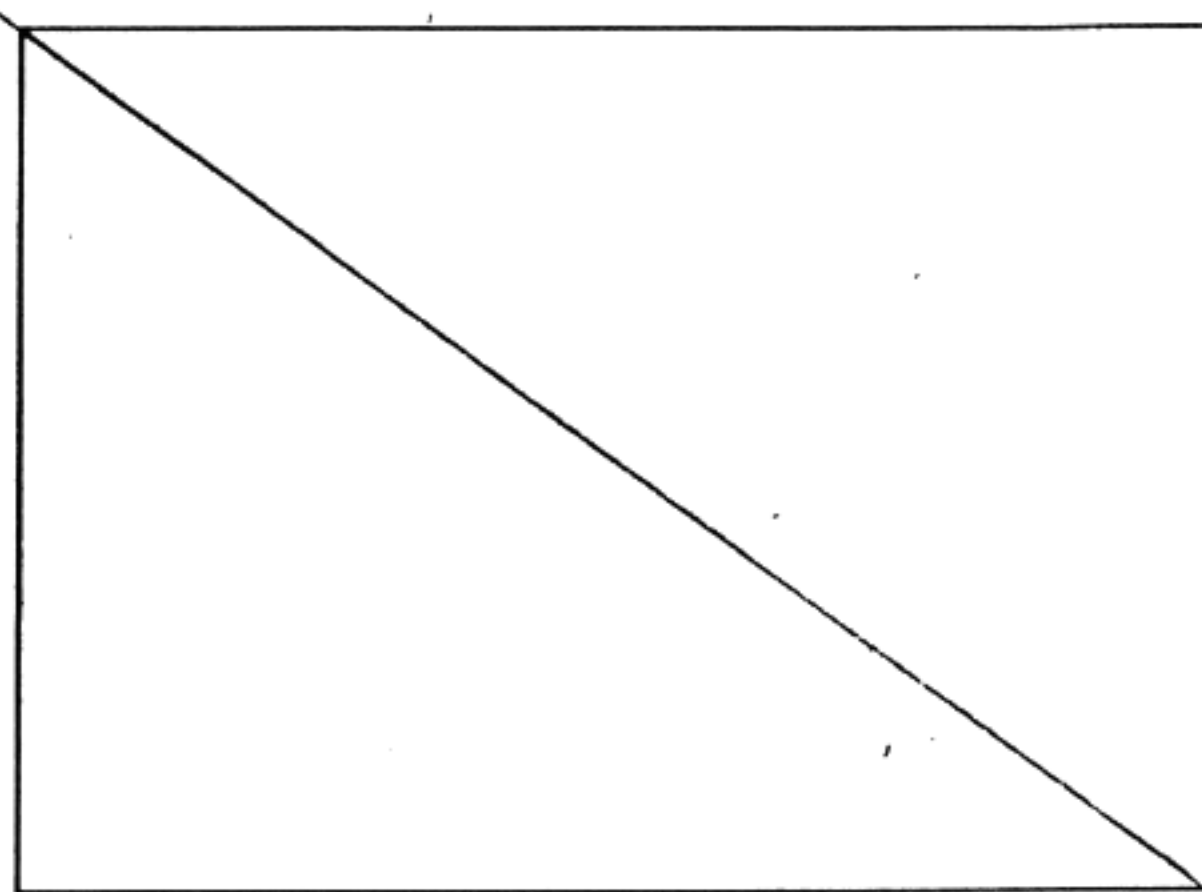

M.S. SOUNDWAVE

CONT

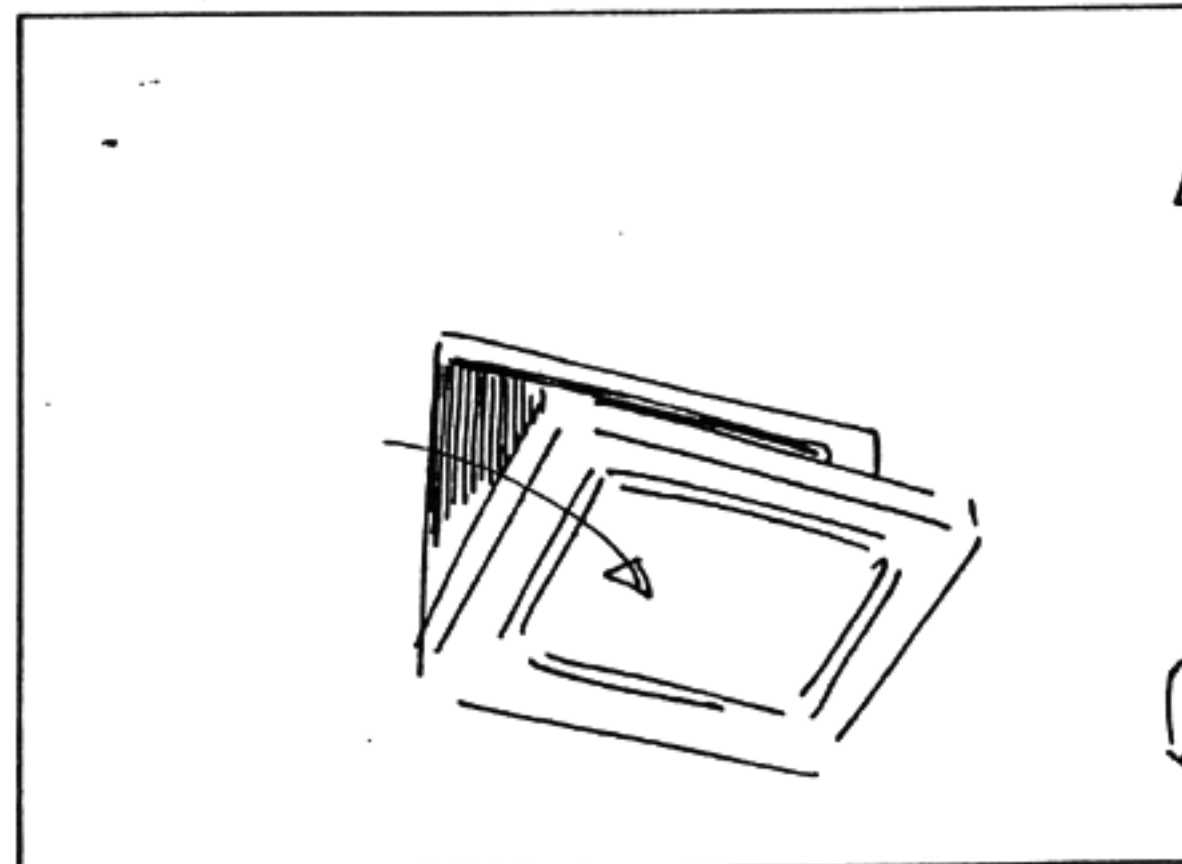

... THE DOOR IN HIS CHEST OPENS ...

CONT

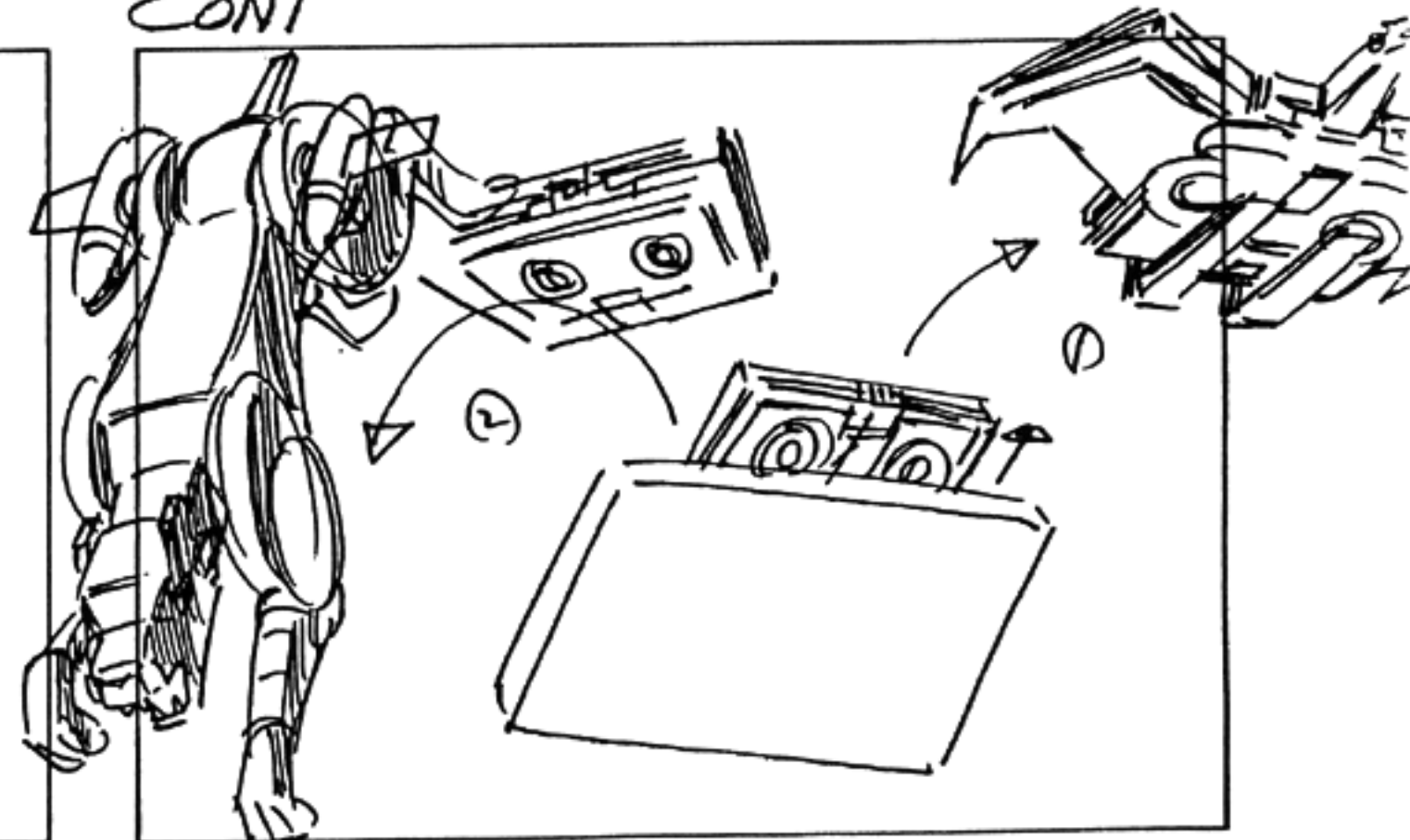

... AND RAVAGE & LASERBEAK POP OUT AND TRANSFORM.

201

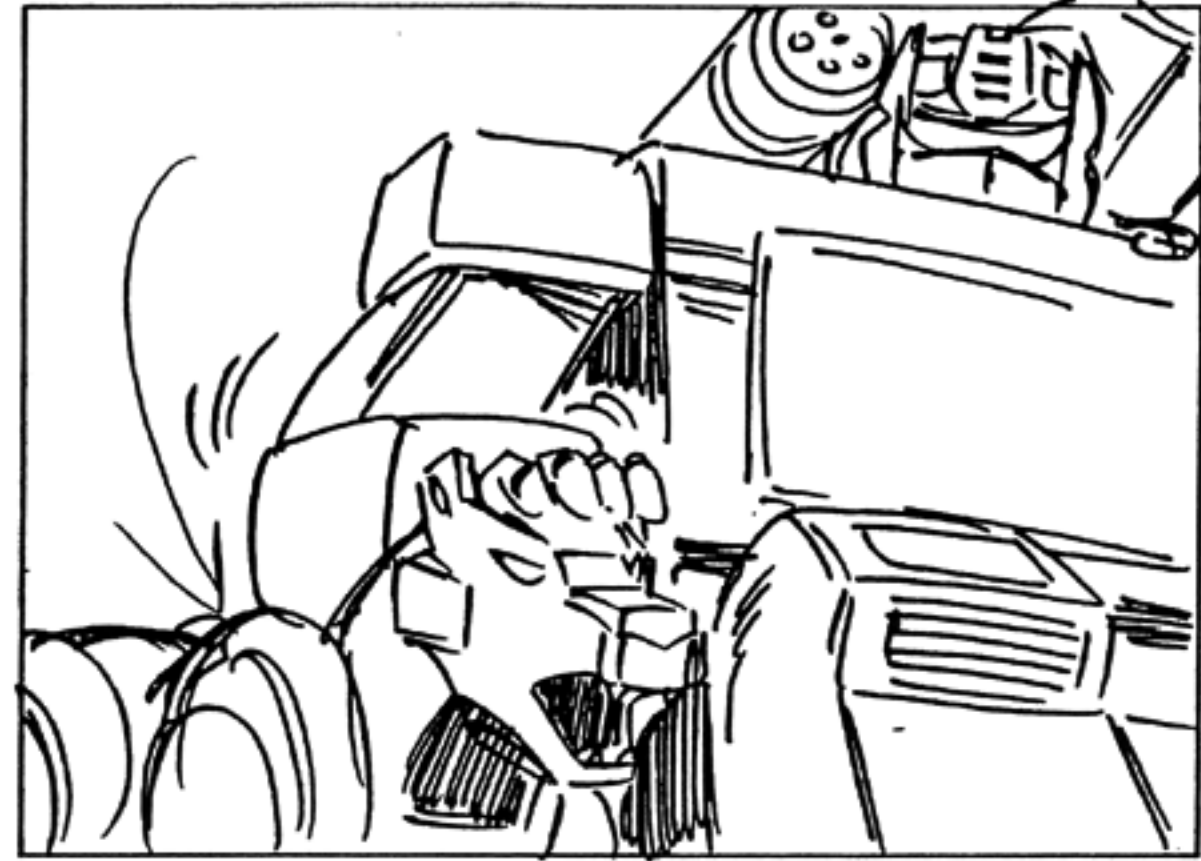
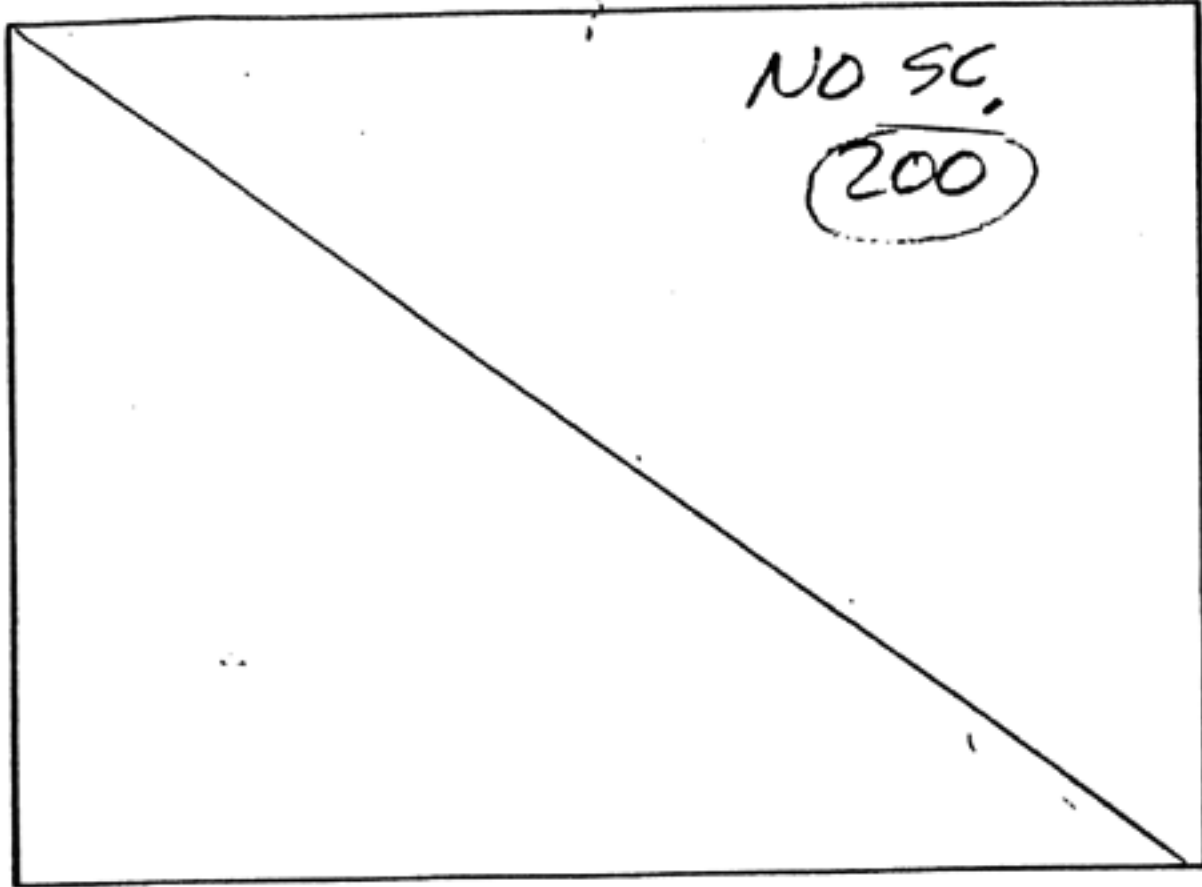

1. M.S. RAVAGE & SOUNDWAVE. RAVAGE SITS NEXT TO SOUNDWAVE WHO PATS HIM  
CONT

202

TOW-13

67

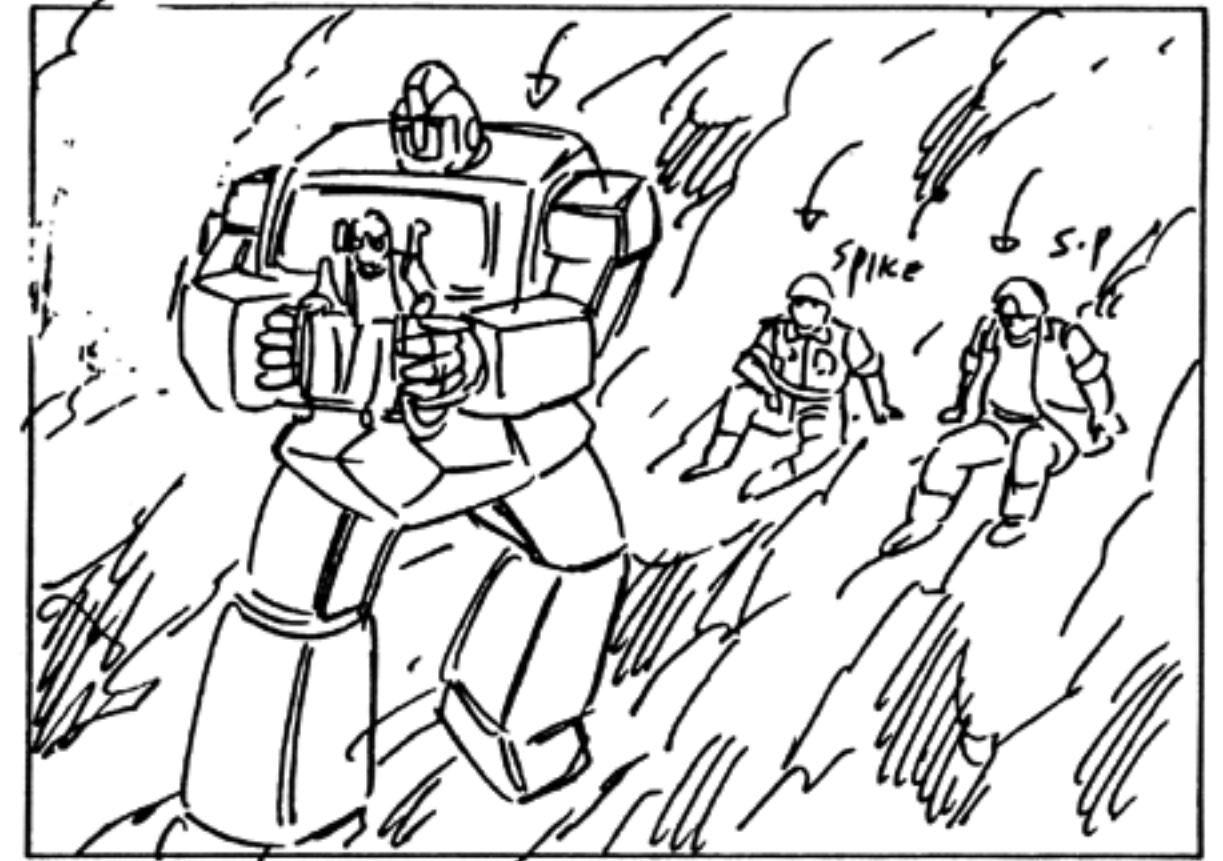

M.I.S. IRONHIDE, CHIP, SPIKE SPARKPLUG TAKE UP THEIR POSITION ON THE BASINS WALL.

CONT

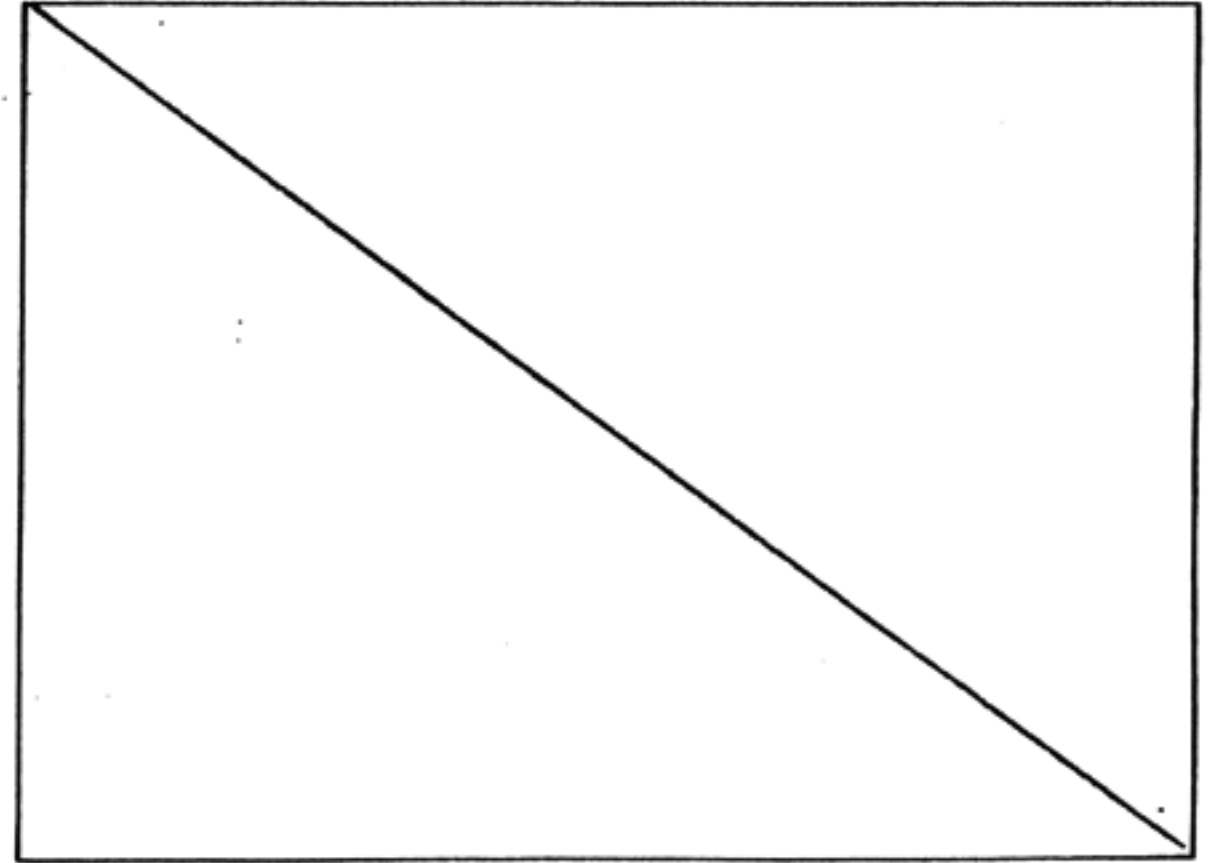
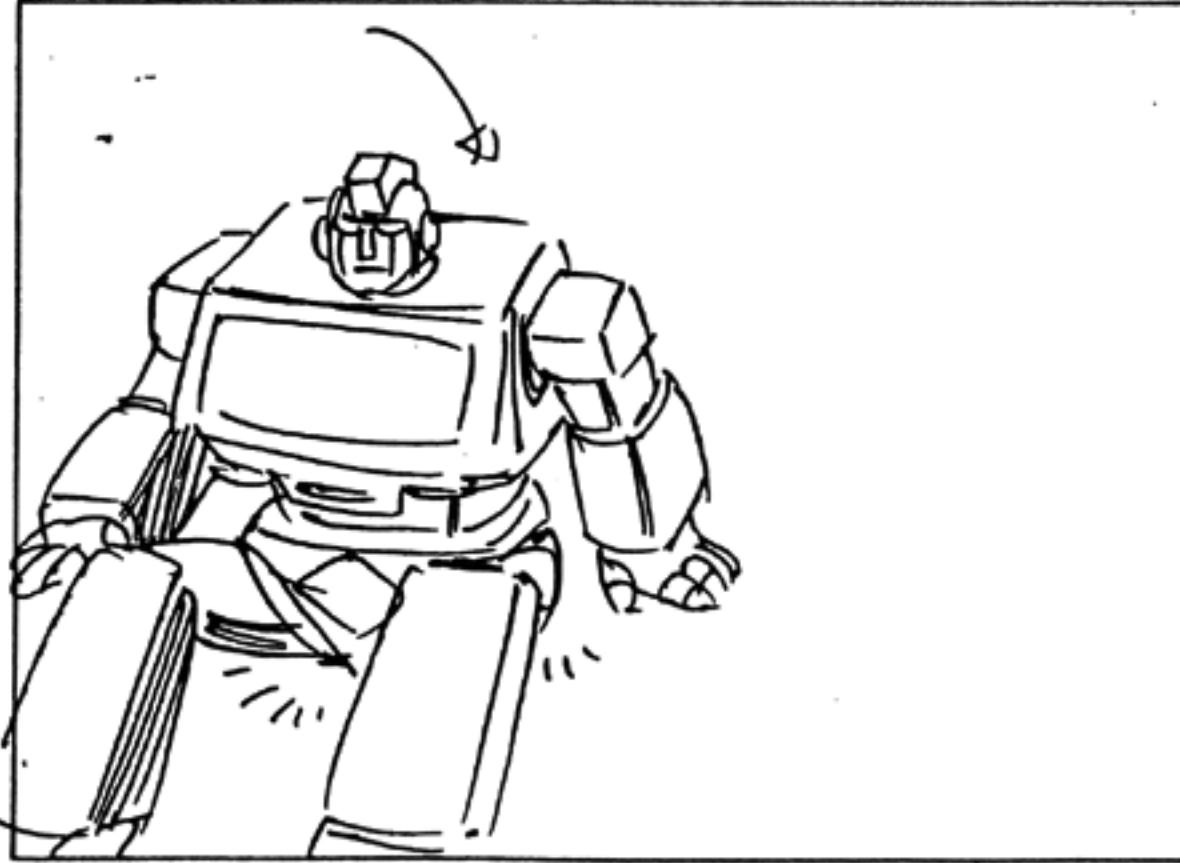
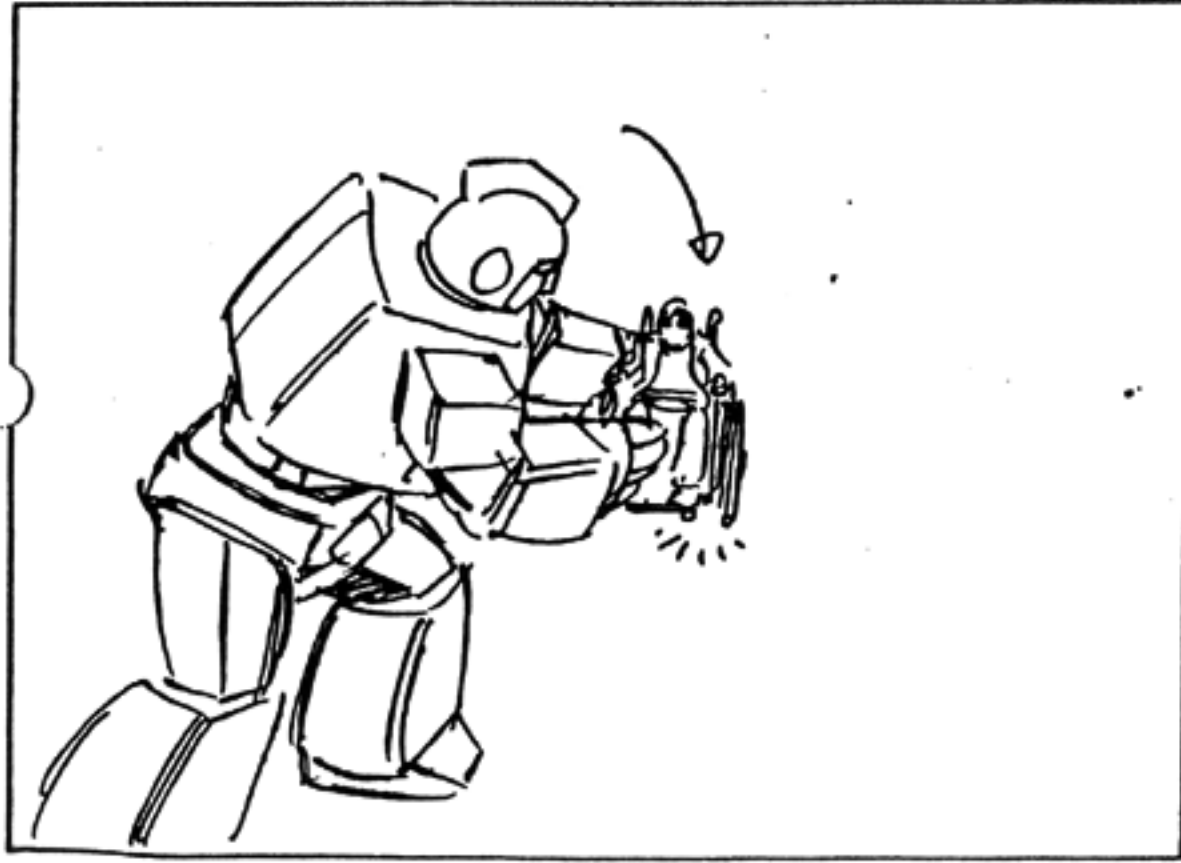

203

TRUCK OUT 10 FIELD

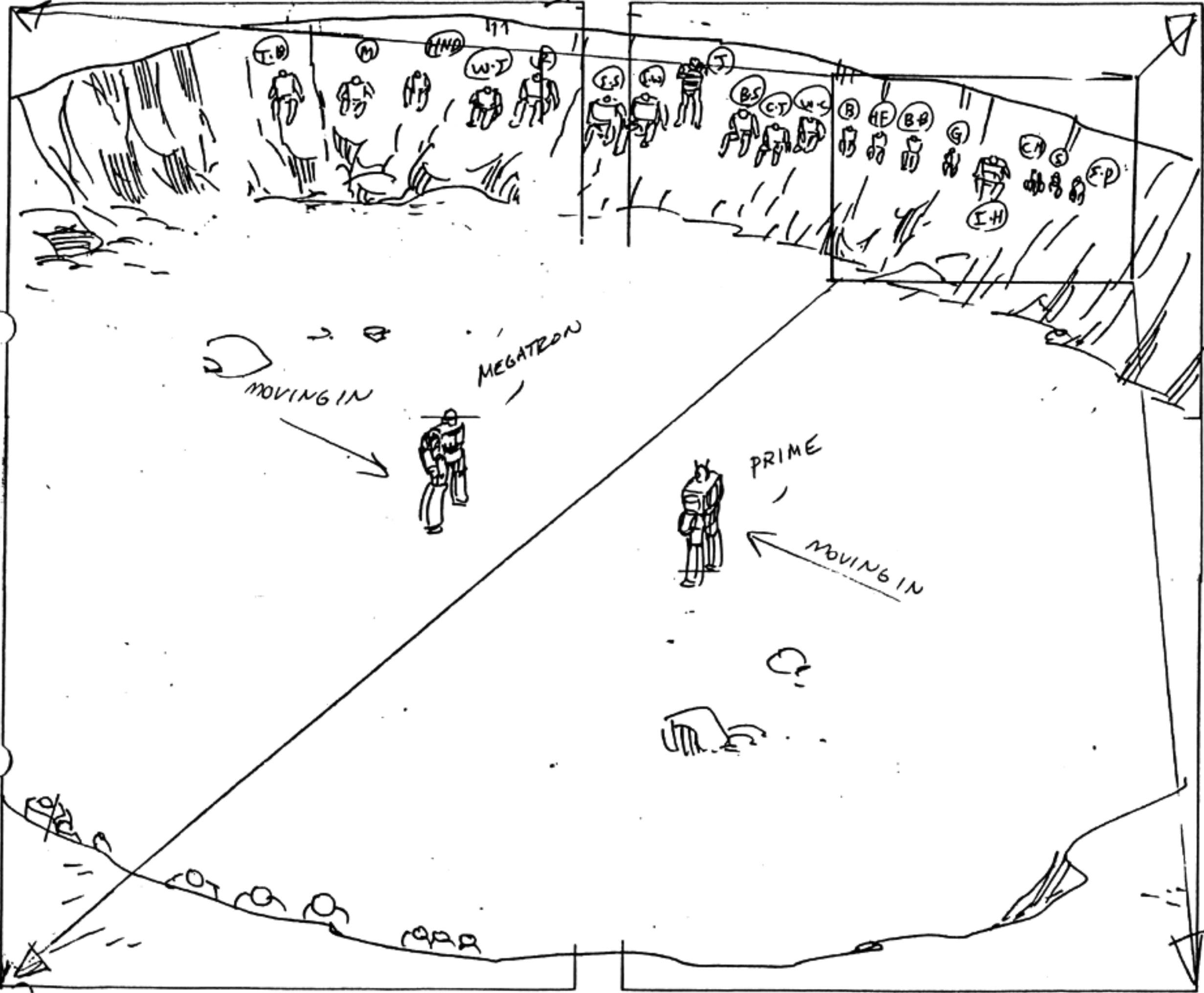

204

700 - 13 B6 PAN

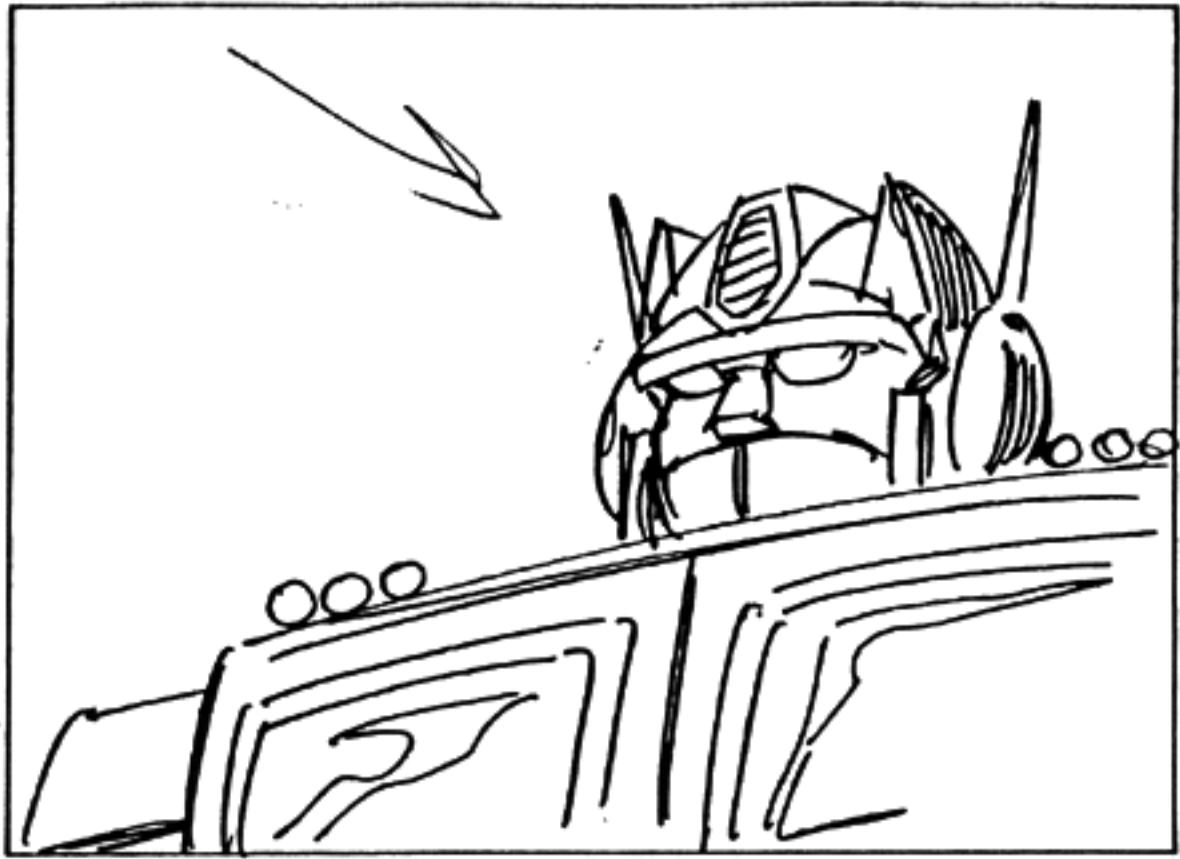

CU PRIME, WALKING  
PRIME: SOLO COMBAT MEGATRON.

205

B6 PAN

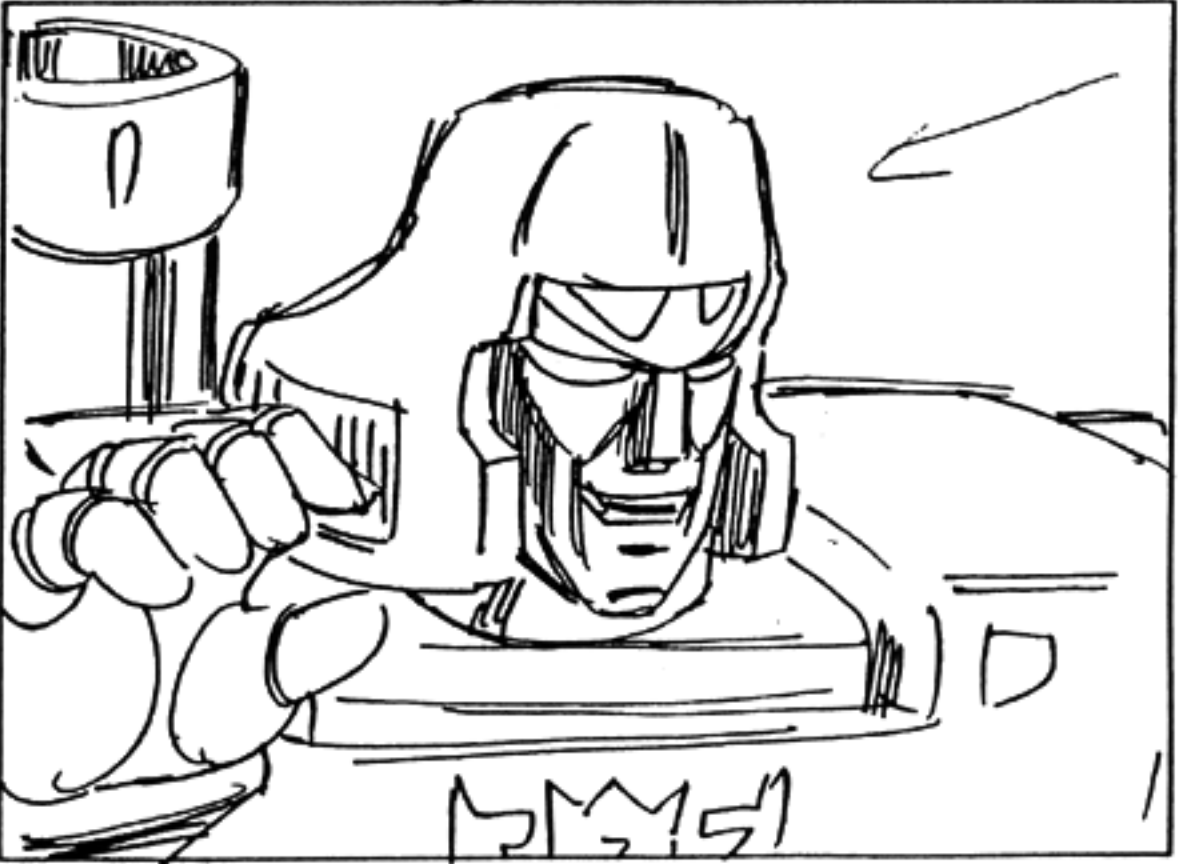

CU MEGATRON, WALKING, RAISES HAND  
MEGATRON: WITH THE VANQUISHED AND HIS ARMY EXILED TO DEEP SPACE FOREVER!

THE ROCKY BASIN LINED WITH AUTOBOTS & DECEPTICONS.  
PRIME & MEGATRON APPROACH EACH OTHER IN THE CENTER

206

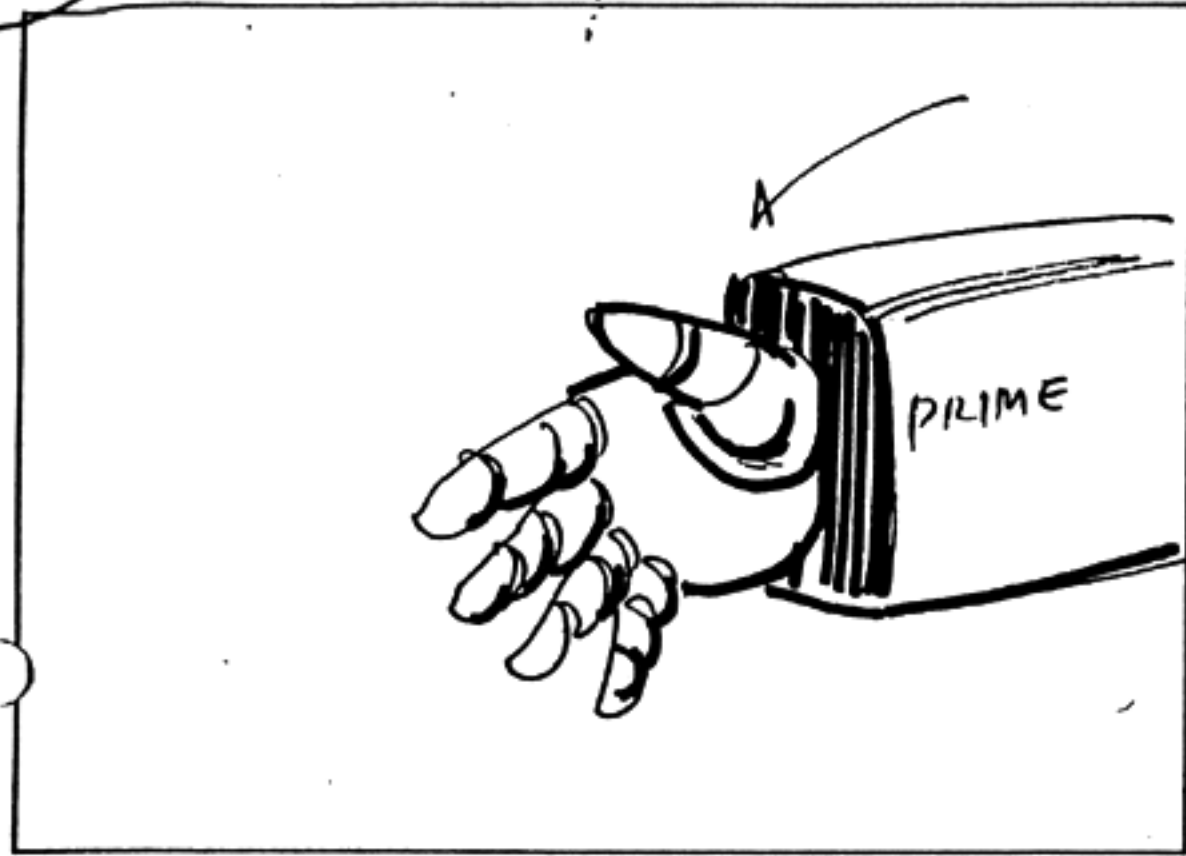

CU PRIME'S HAND ...

CONT

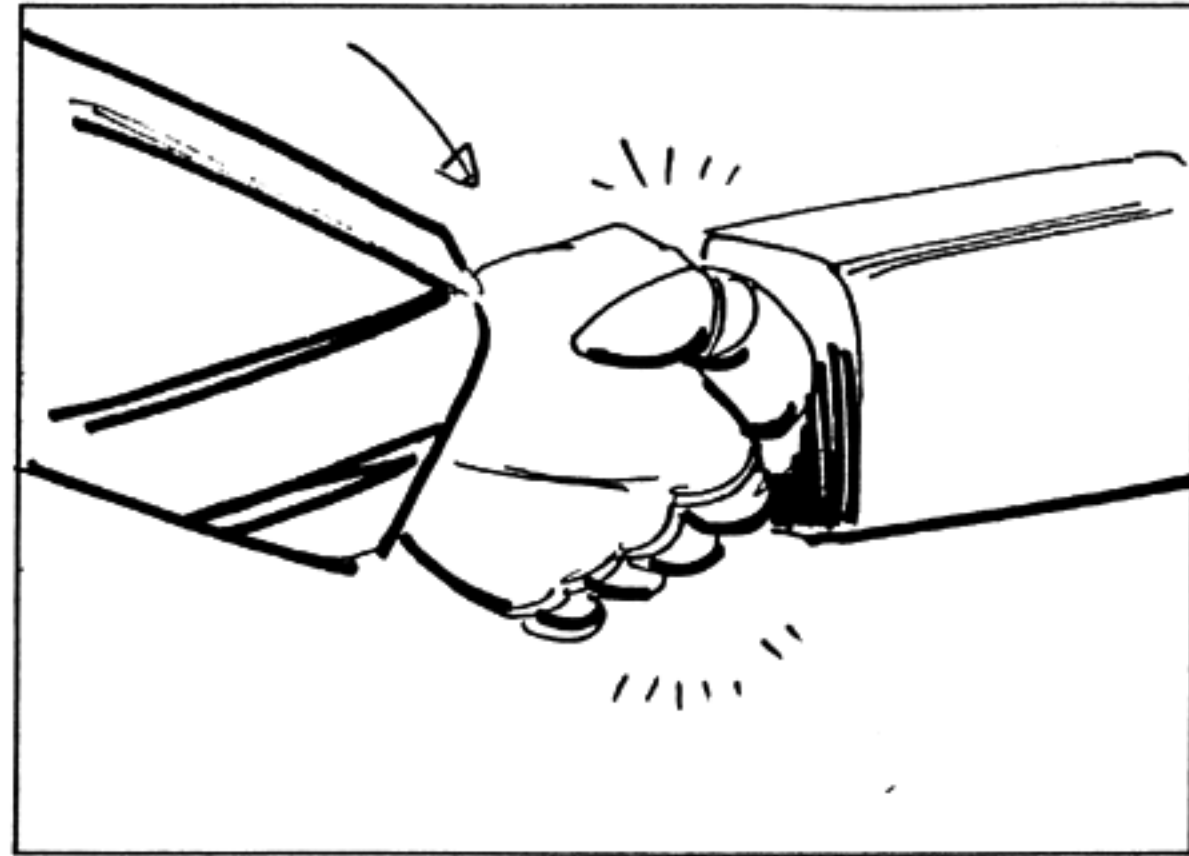

... MEGATRON'S HAND CLASPS PRIME'S ...

CONT

700-13

69

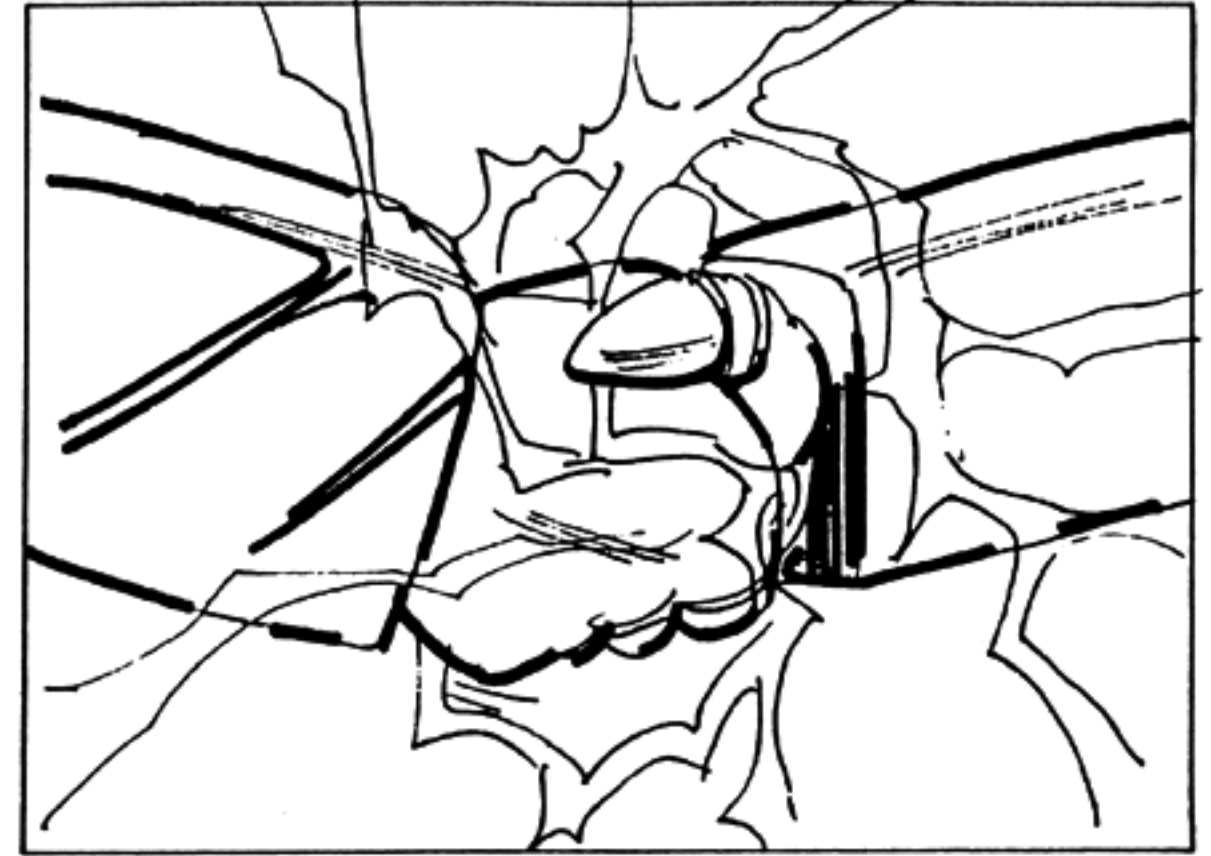

CAUSING IT TO SPARK & CRACKLE.

207

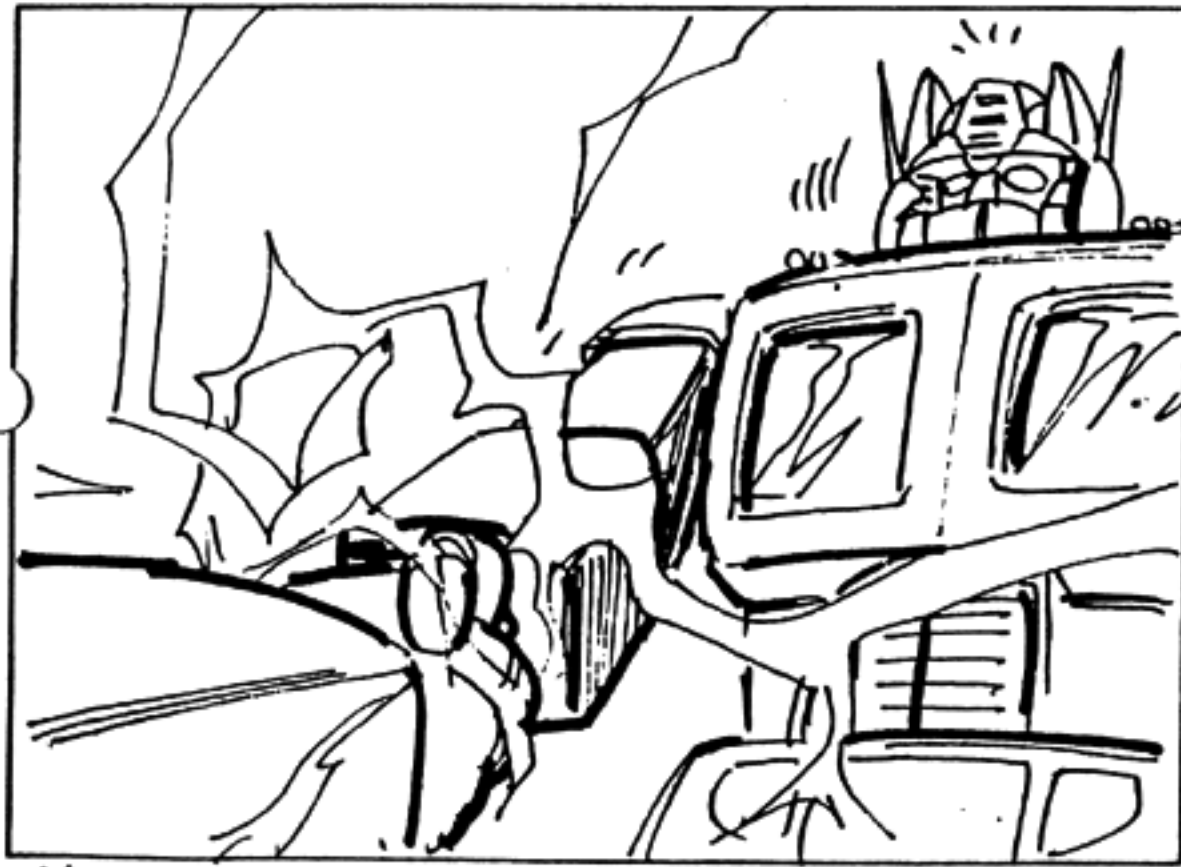

MS. PRIME. HE REACTS WITH SURPRISE.

208



CU MEGATRON HE SMILES.

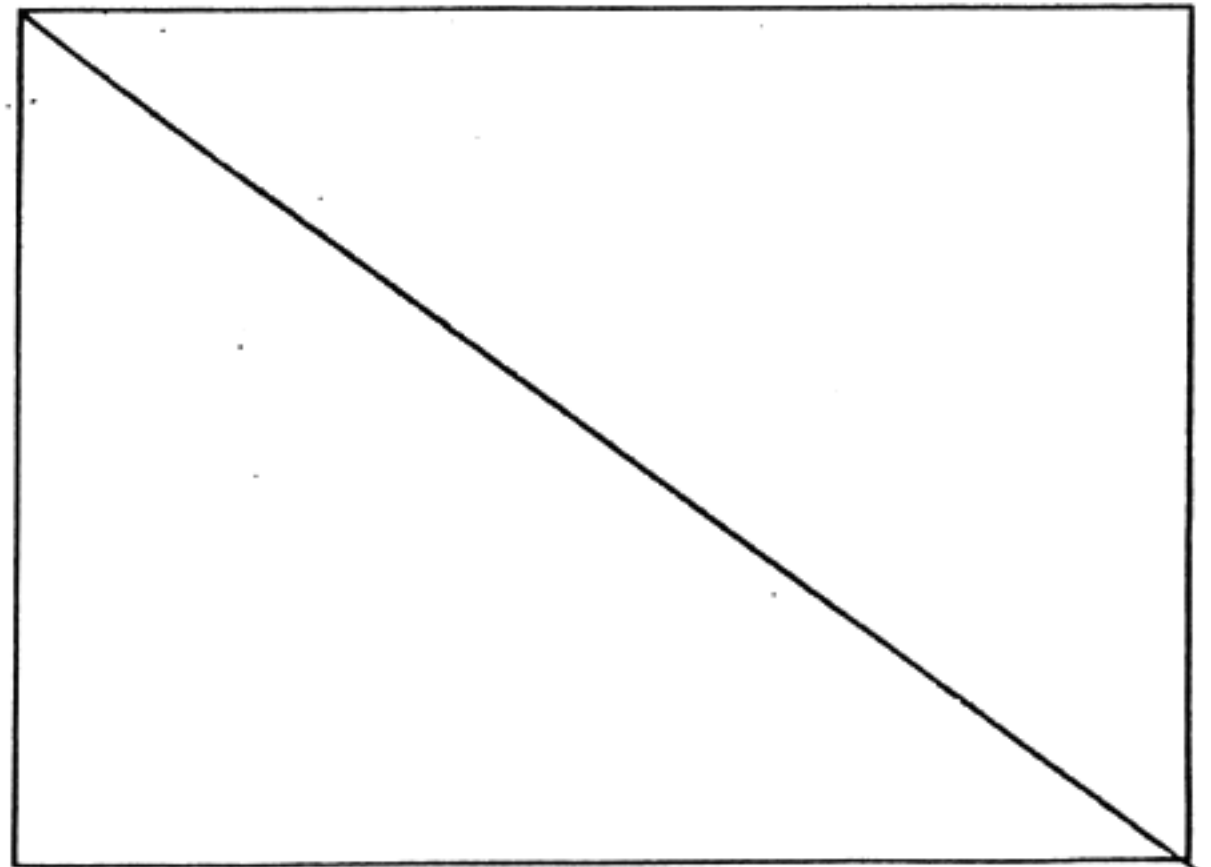

209

STOP

PAN

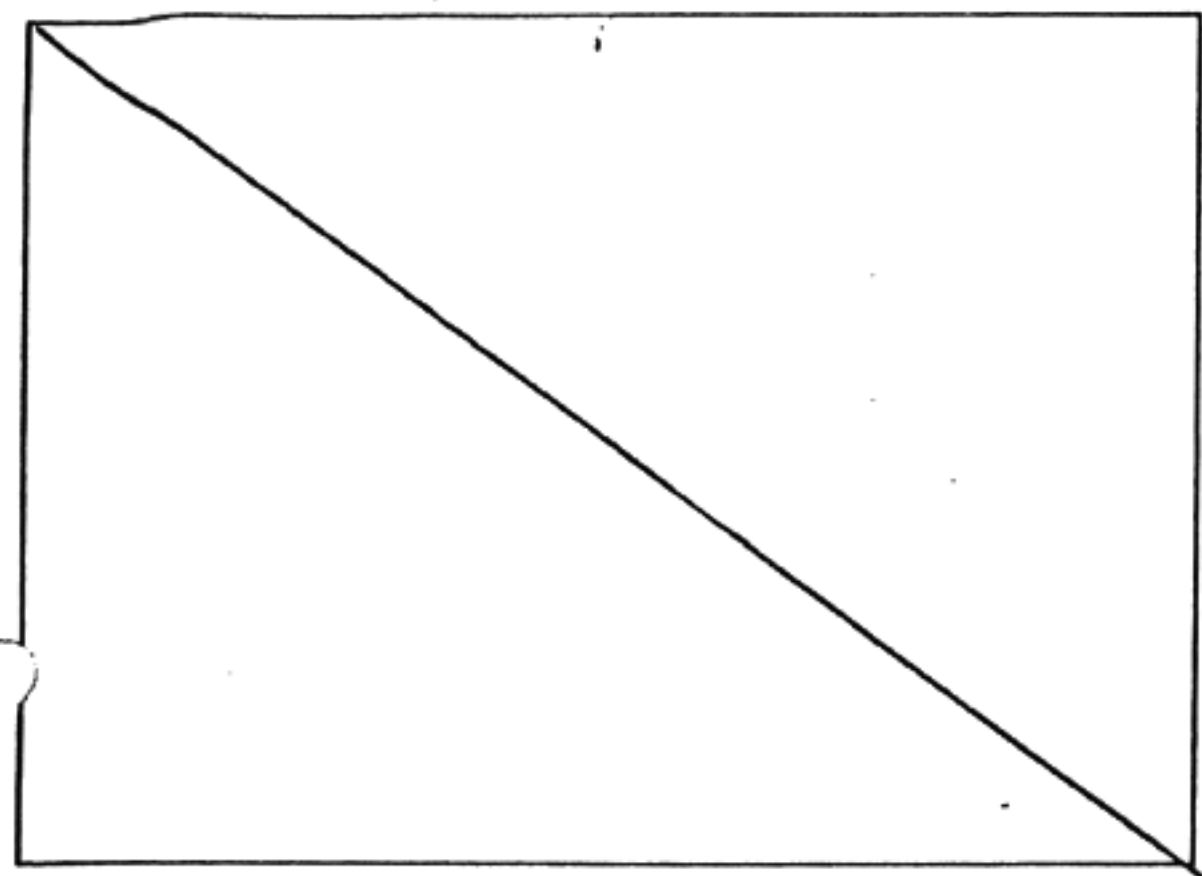

M.S. MEGATRON & PRIME, AS MEGATRON SWINGS PRIME AROUND BY THE HAND, AND THEN LETS GO. PRIME IS HURLED ACROSS THE BASIN.

210



M.S. IRONHIDE, CHIP, SPIKE, SPARKPLUG. THEY ARE SHOCKED!

211

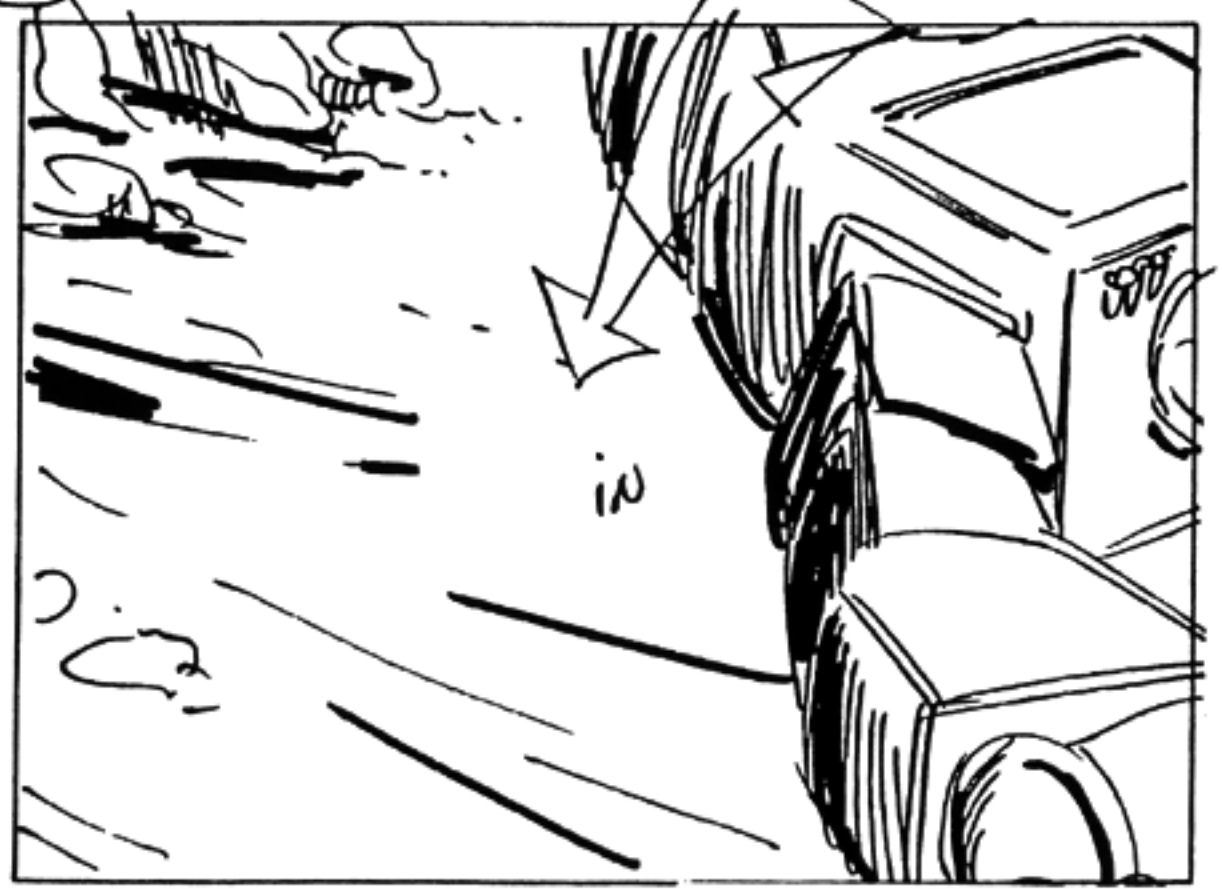

D.S PRIME.. HE FALLS AND HITS HARID ON HIS BACK...

CONT

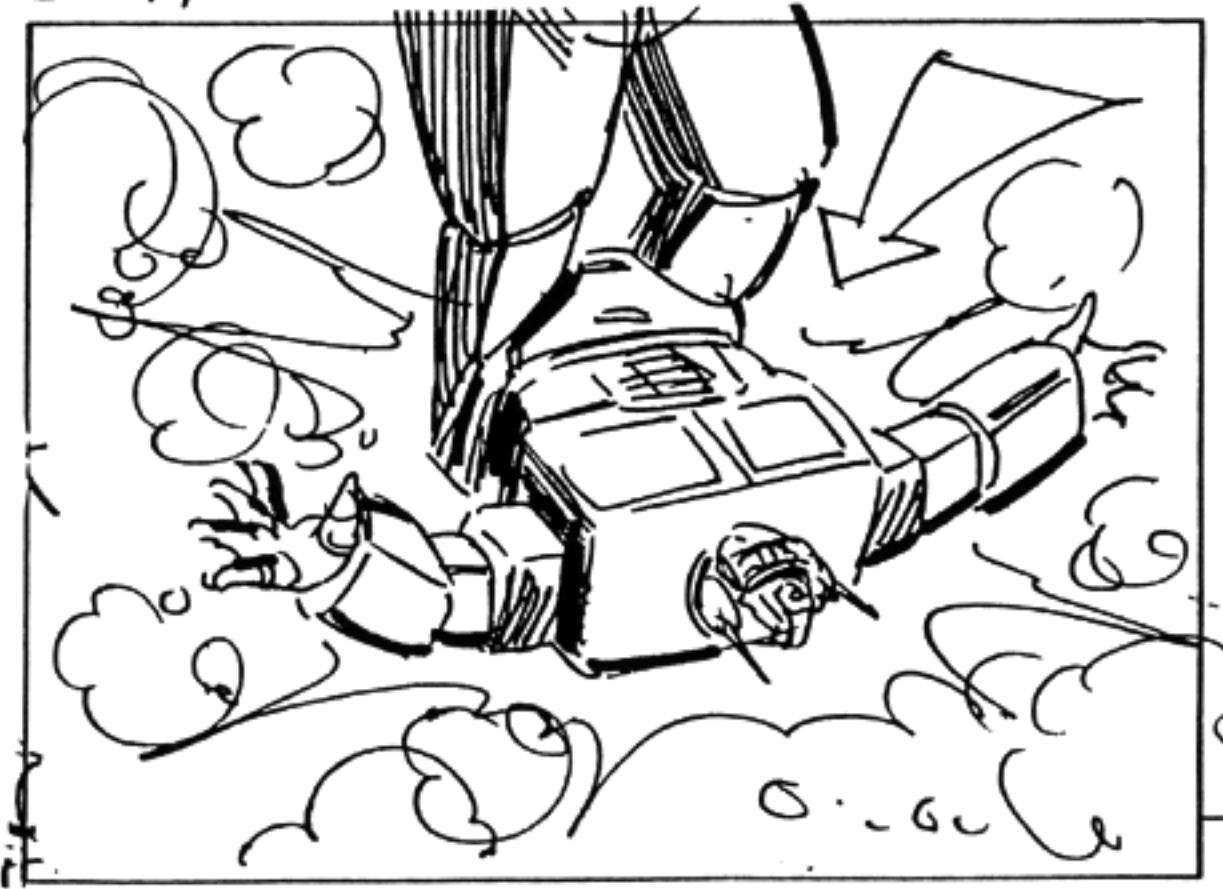

CONT

CONT 211

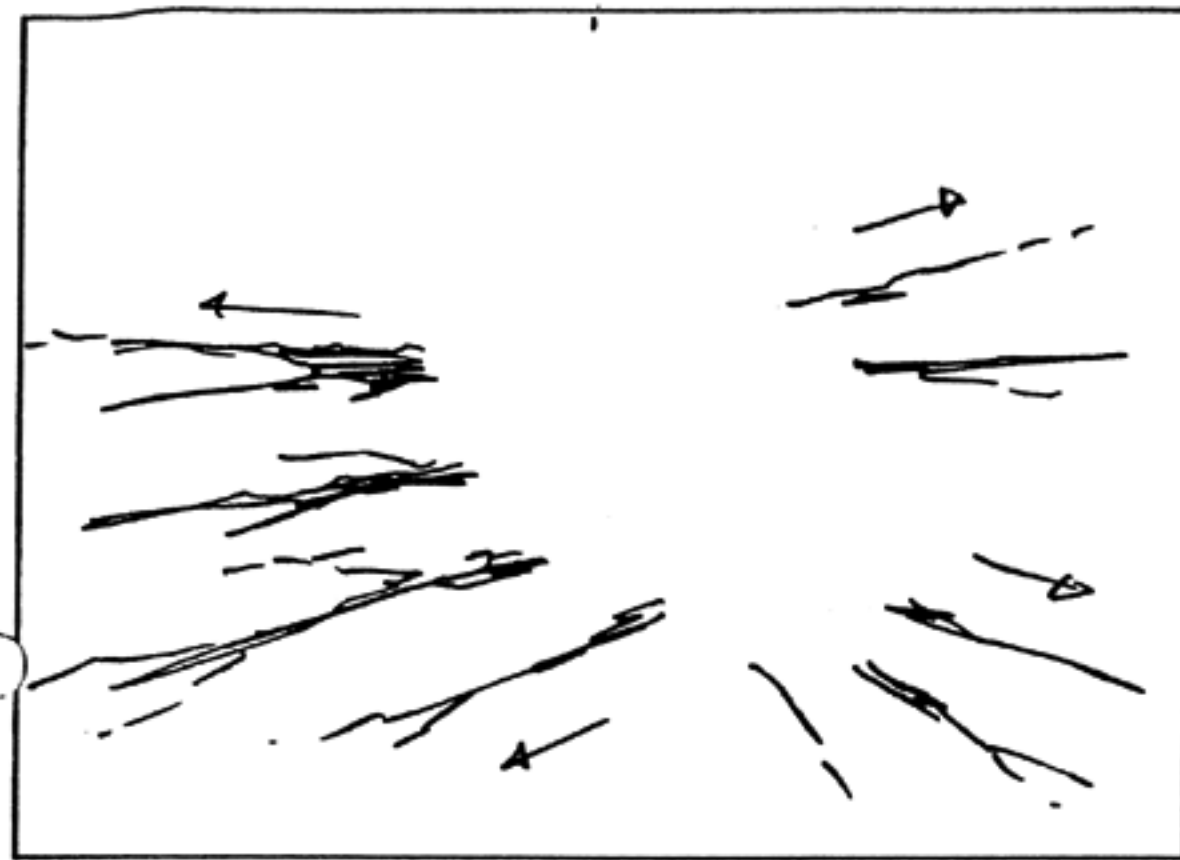

... THE GROUNDS BELOW HIM COLLAPSE.

212

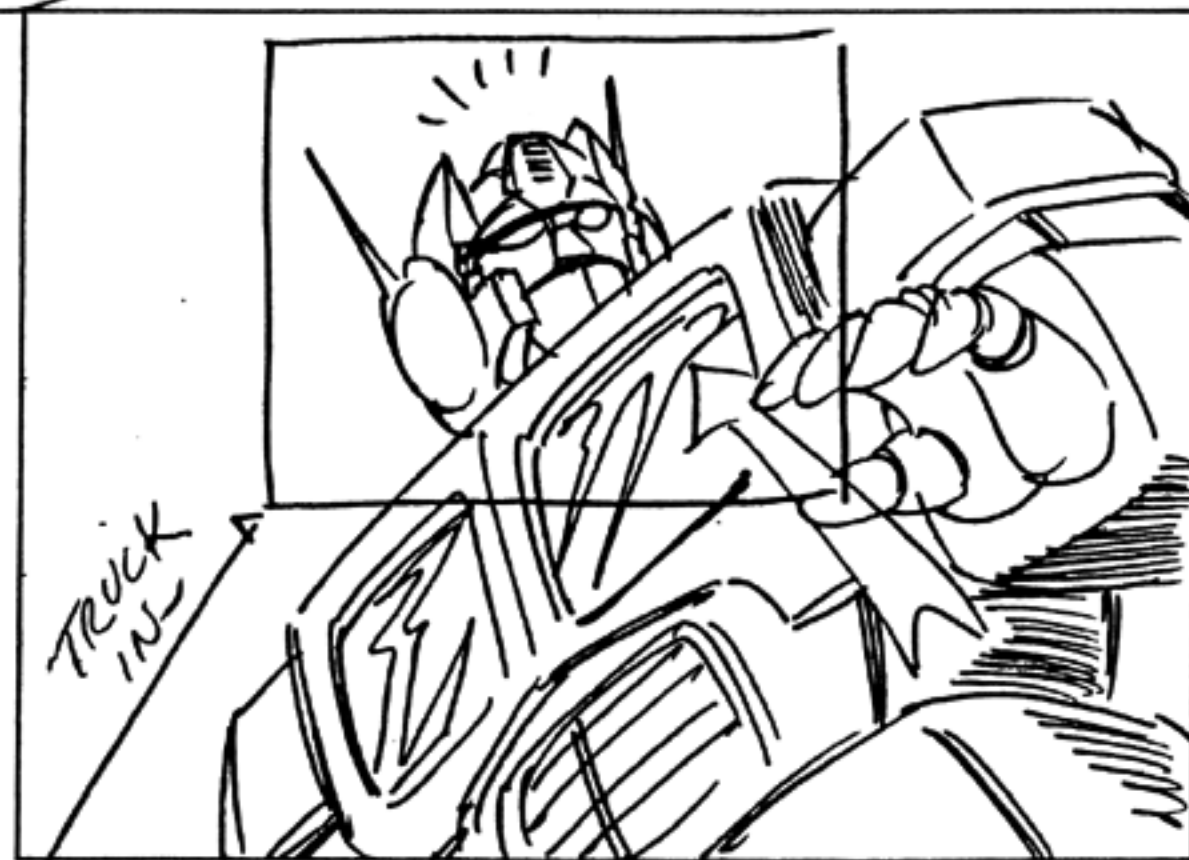

M.S. PRIME. HE GETS TO HIS FEET  
PRIME! NEVER KNEW HE WAS SO...STRONG!

213

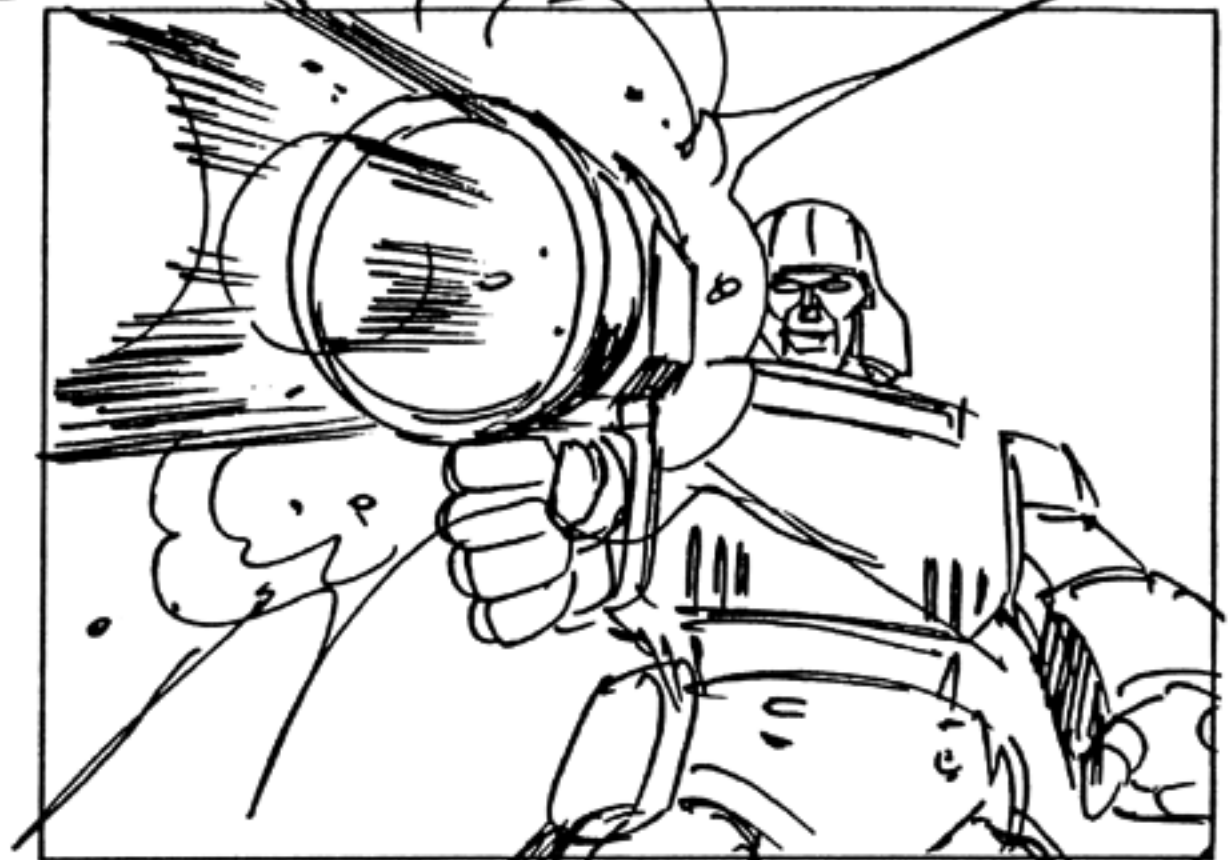

M.S. MEGATRON HE AIMS HIS  
FUSION CANNON AND FIRES OUT  
STARSCREAM CLUSTER BOMBS

700-13

71

214

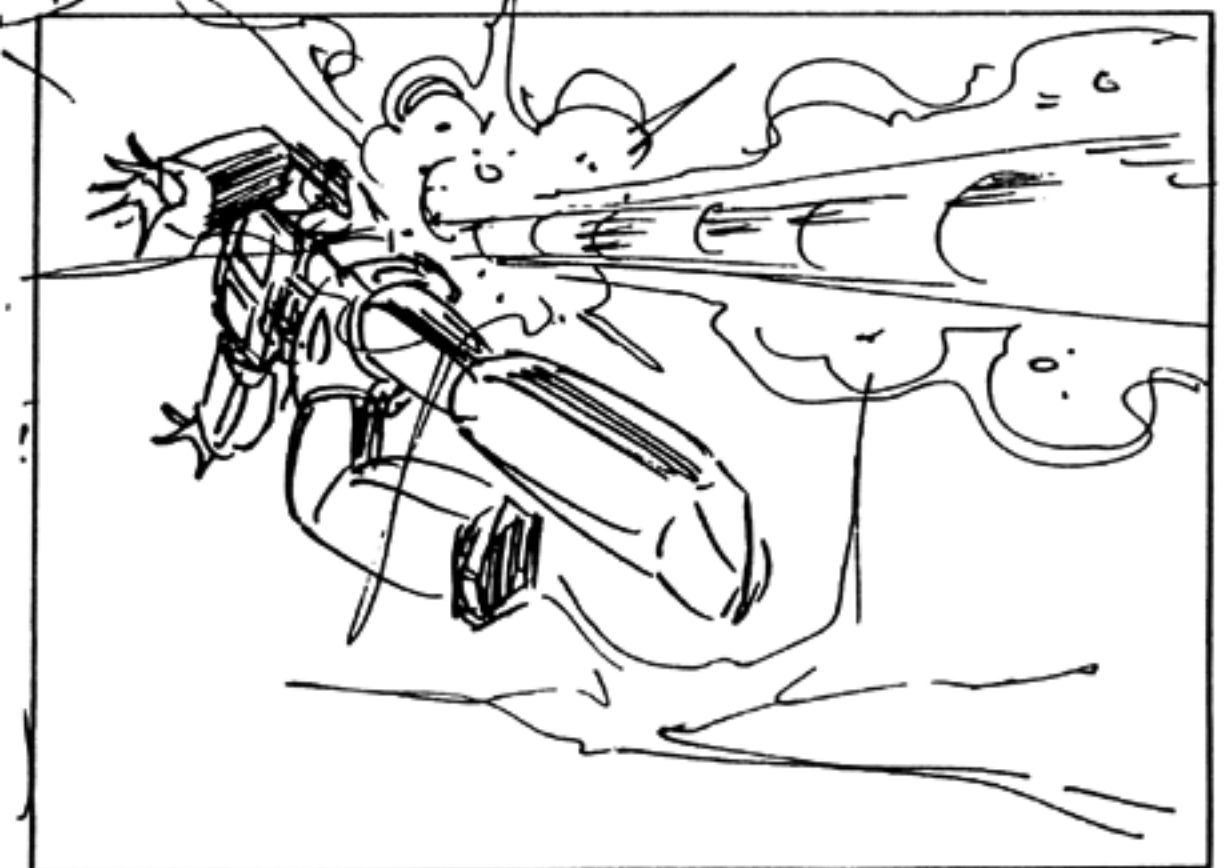

L.S. PRIME. THE CLUSTER BOMBS  
HIT HIM KNOCKING HIM OFF OF HIS FEET,

215



2 SHOT SKYWARP & STARSCREAM  
STARSCREAM (SOTTO) MY POWER CHIP GIVES  
HIM THE USE OF MY CLUSTER BOMBS.

216

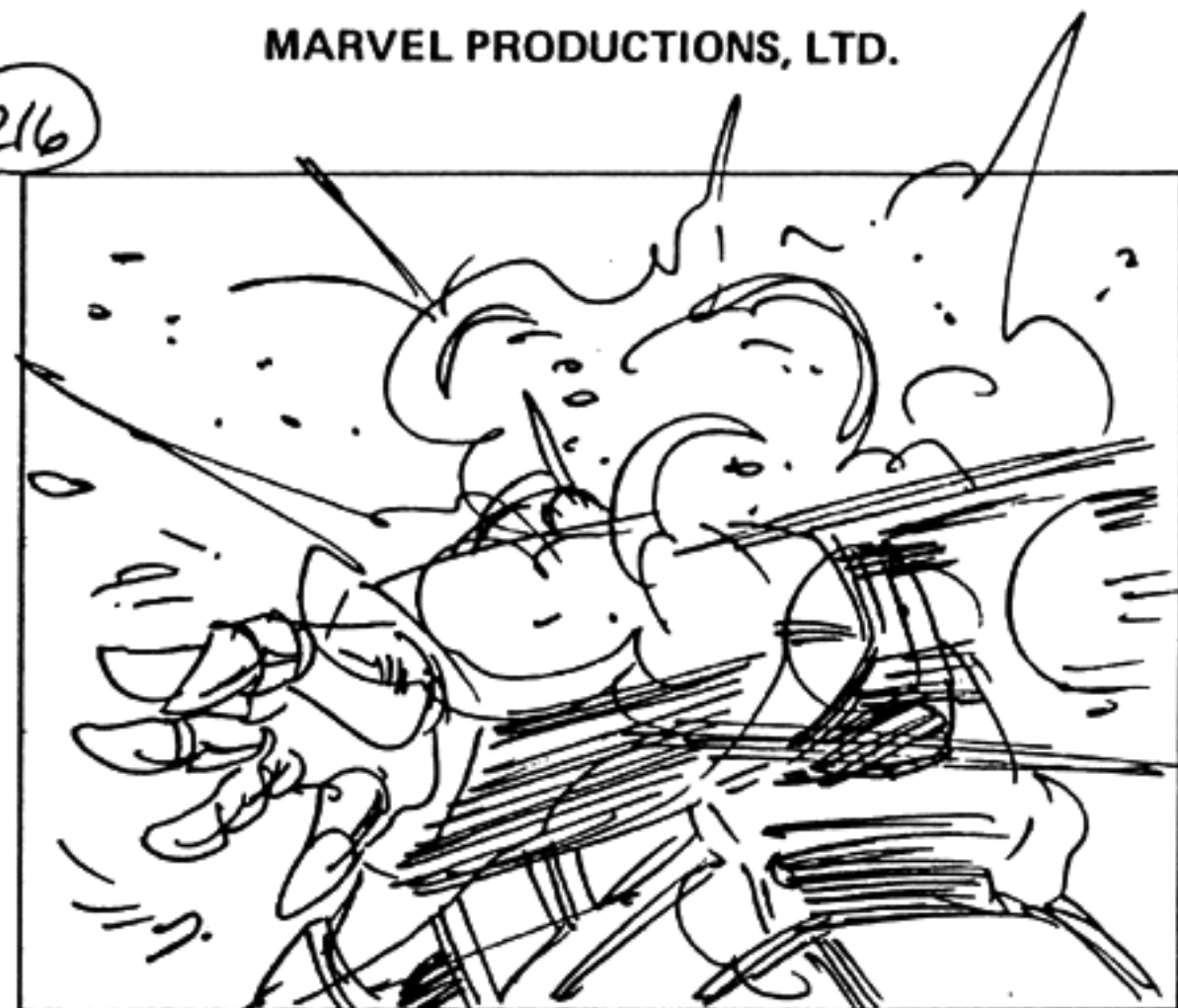

MICU. PRIME AS HE IS BEING  
BUSTED BY MEGATRON, HE GETS  
TO HIS FEET COVERING HIMSELF..

CONT

100-13

72



... WITH HIS HANDS. HE STAND UP AND..

CONT

217

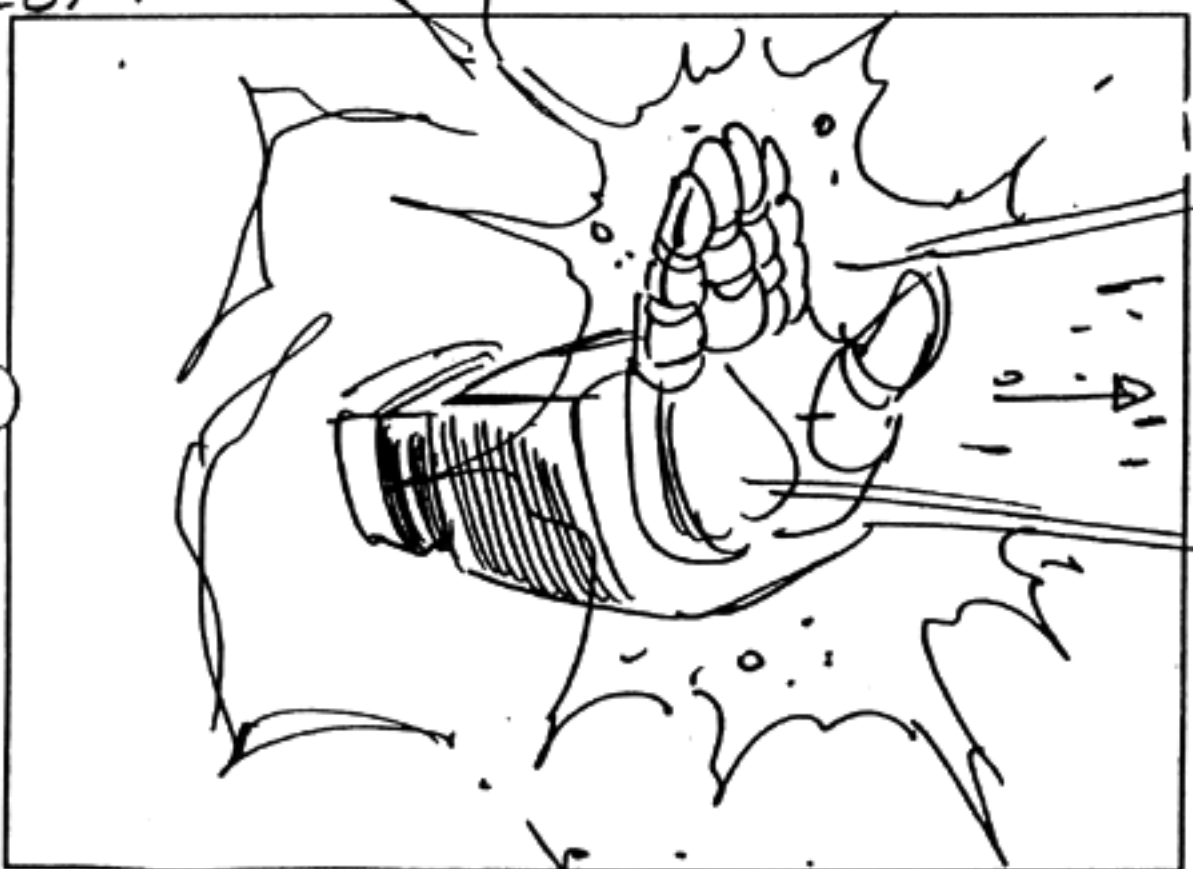

... EXTENDS HIS HAND, SENDING OUT  
AN ELECTRICAL BEAM..

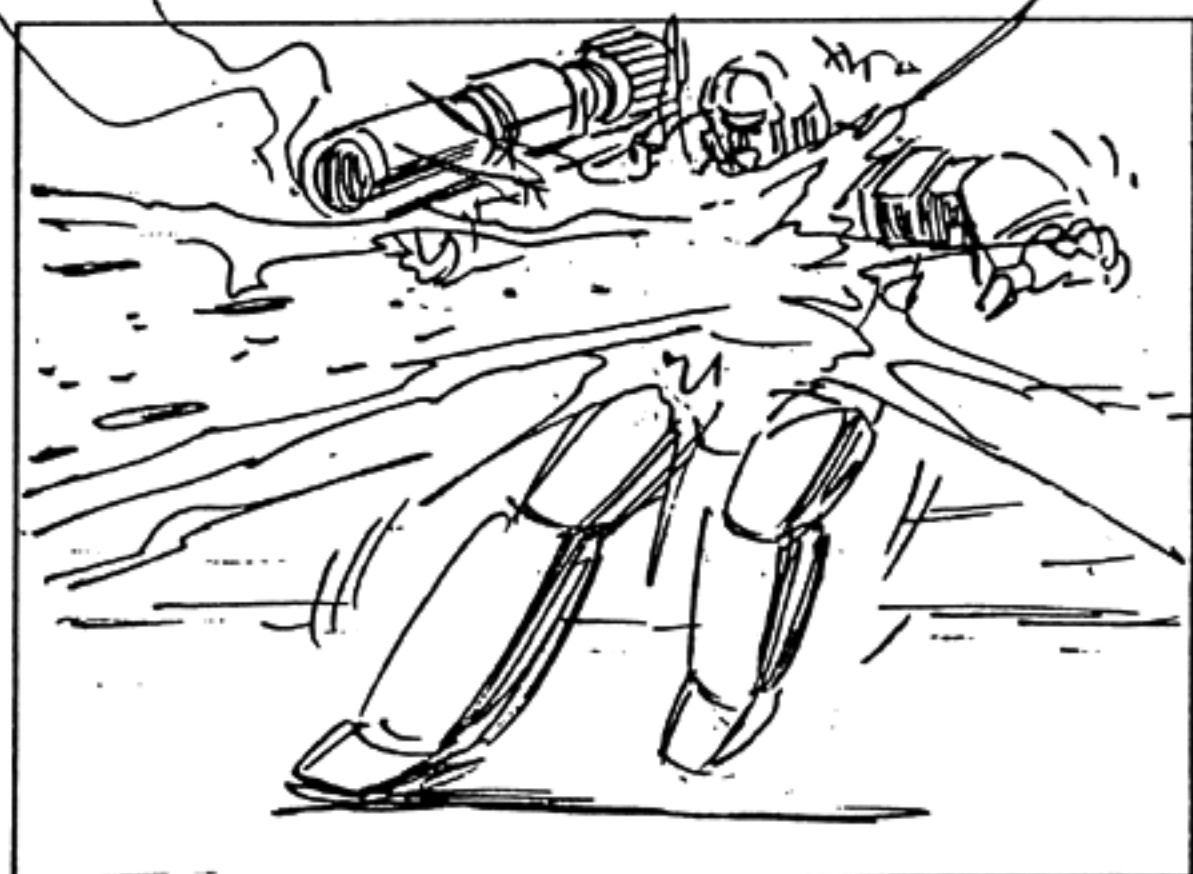

45. MEGATRON THAT RIPS INTO  
MEGATRON.

218



MS. IRONHIDE, CHIP, SPIKE, SPARK PLUG  
SPIKE: AWWRIGHT, OPTIMUS! ZAP IN GOOD!

700-13

72A

219

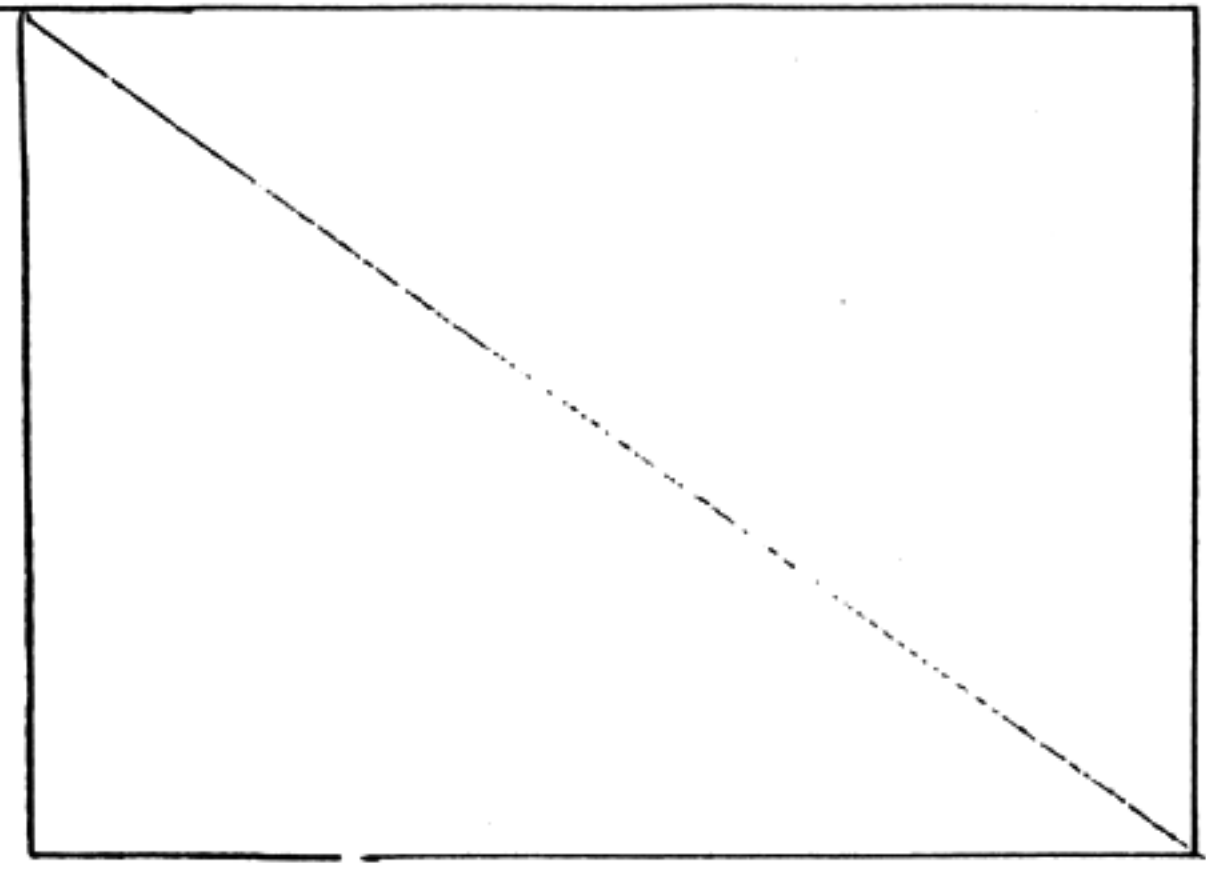
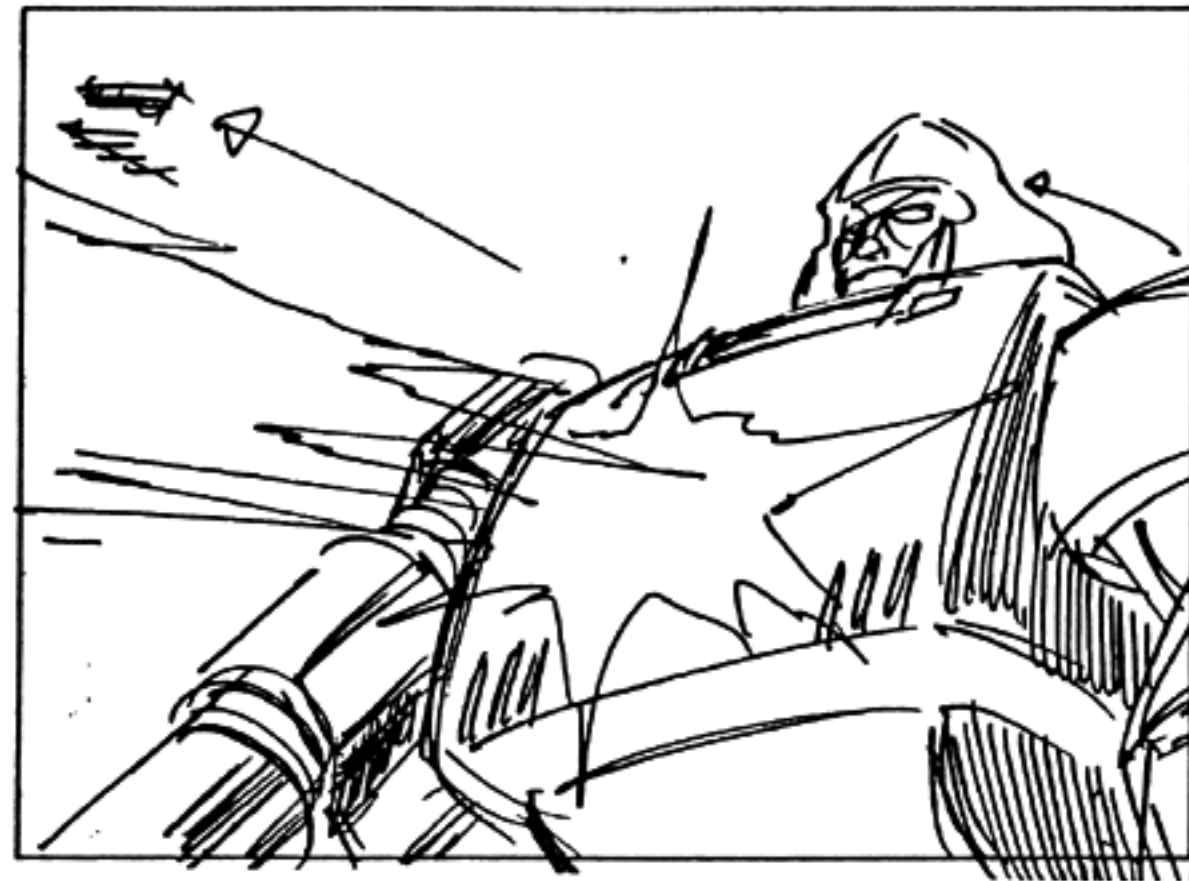
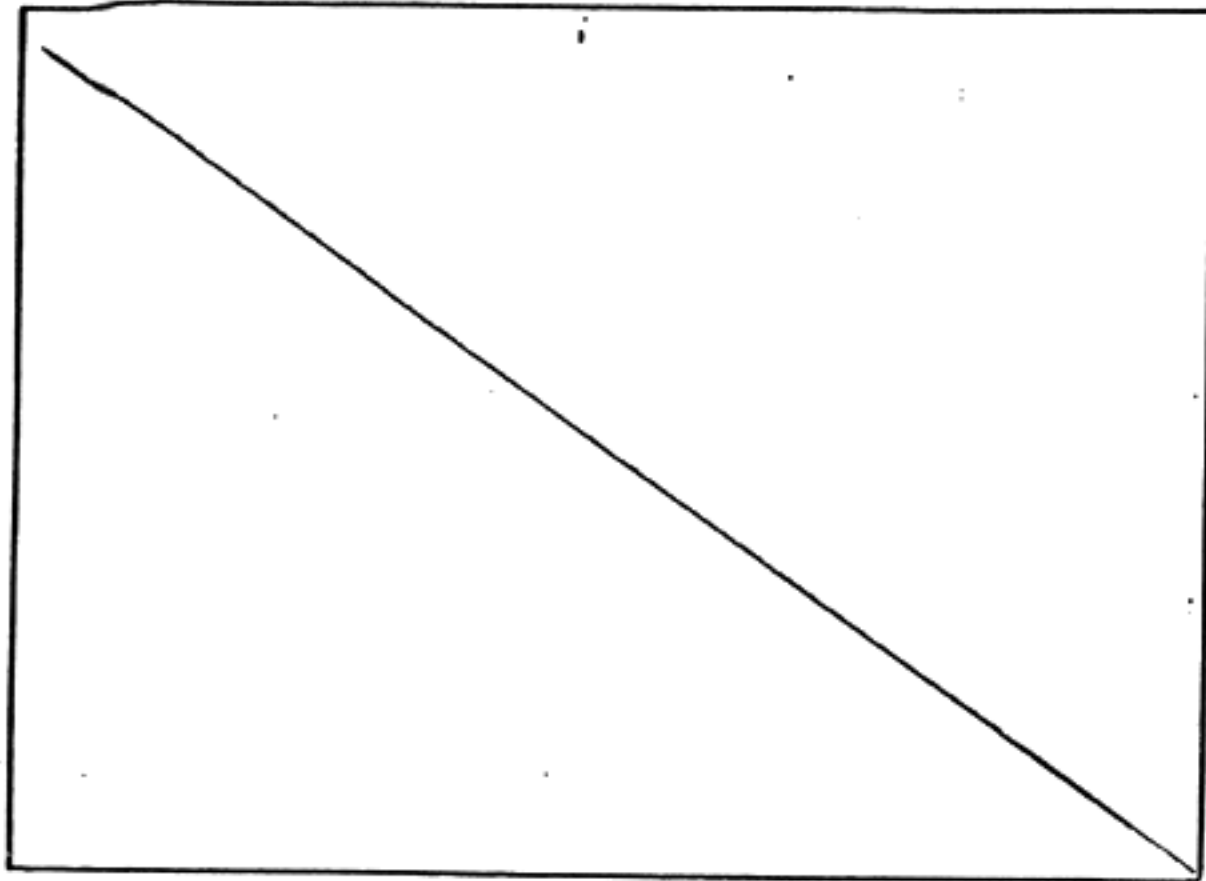

MICU. MEGATRON AS THE ELECTRICAL BOLT BOUNCES OFF OF HIS CHEST.

220 TOWARD PRIME

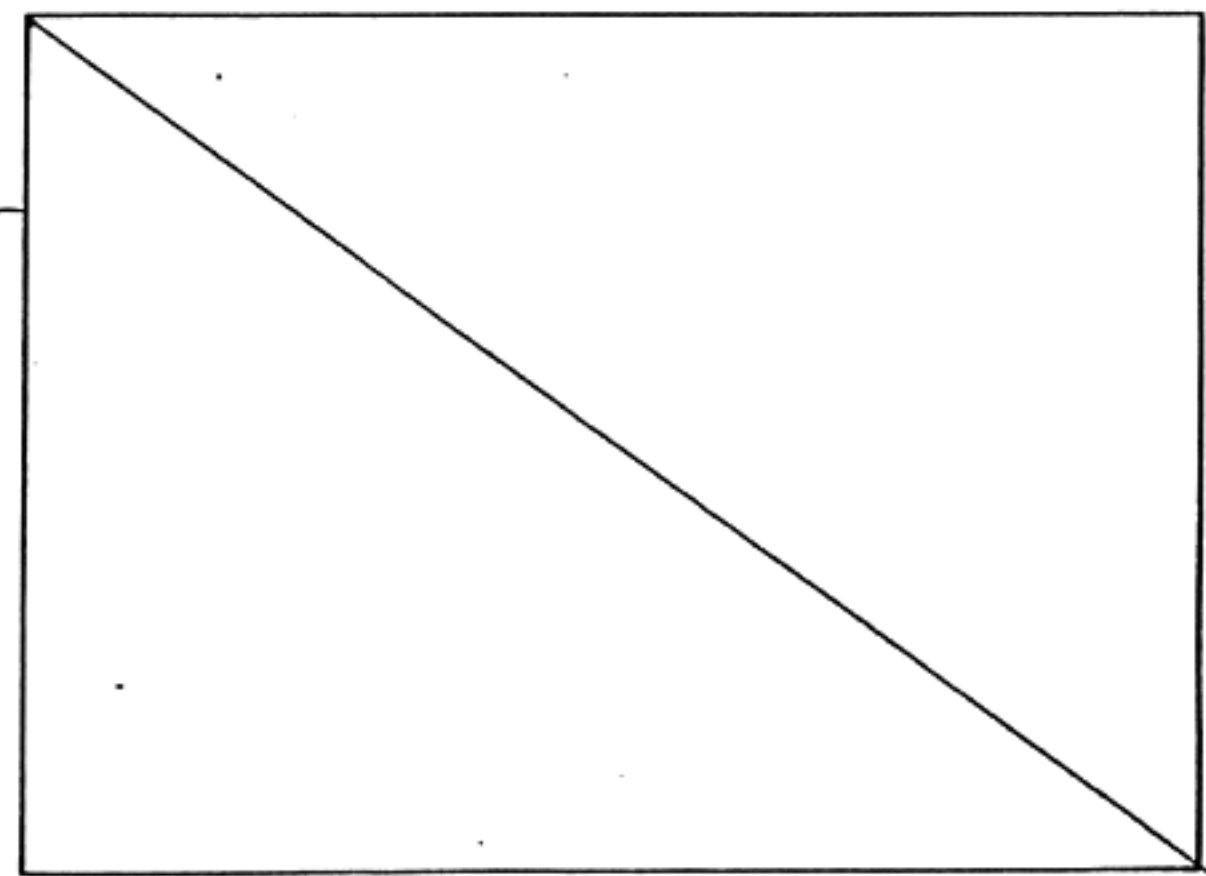
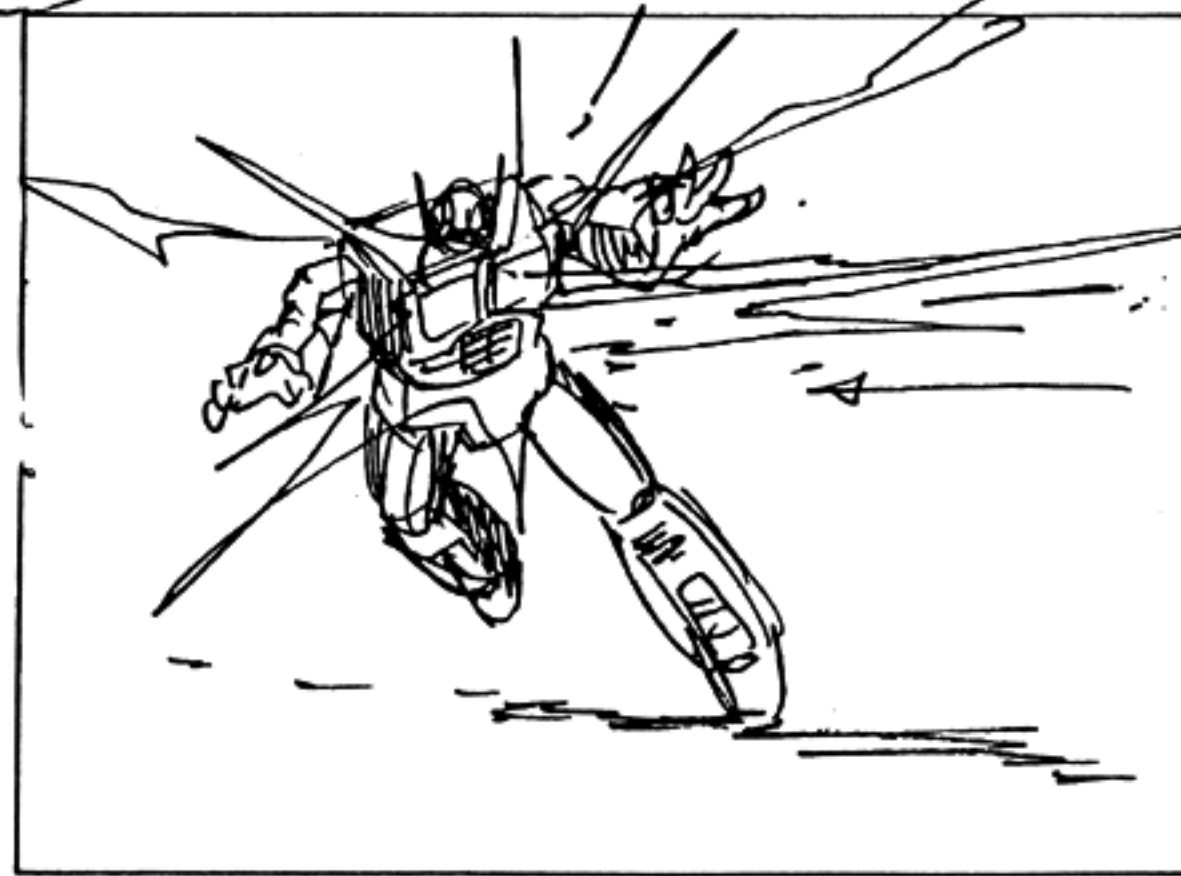
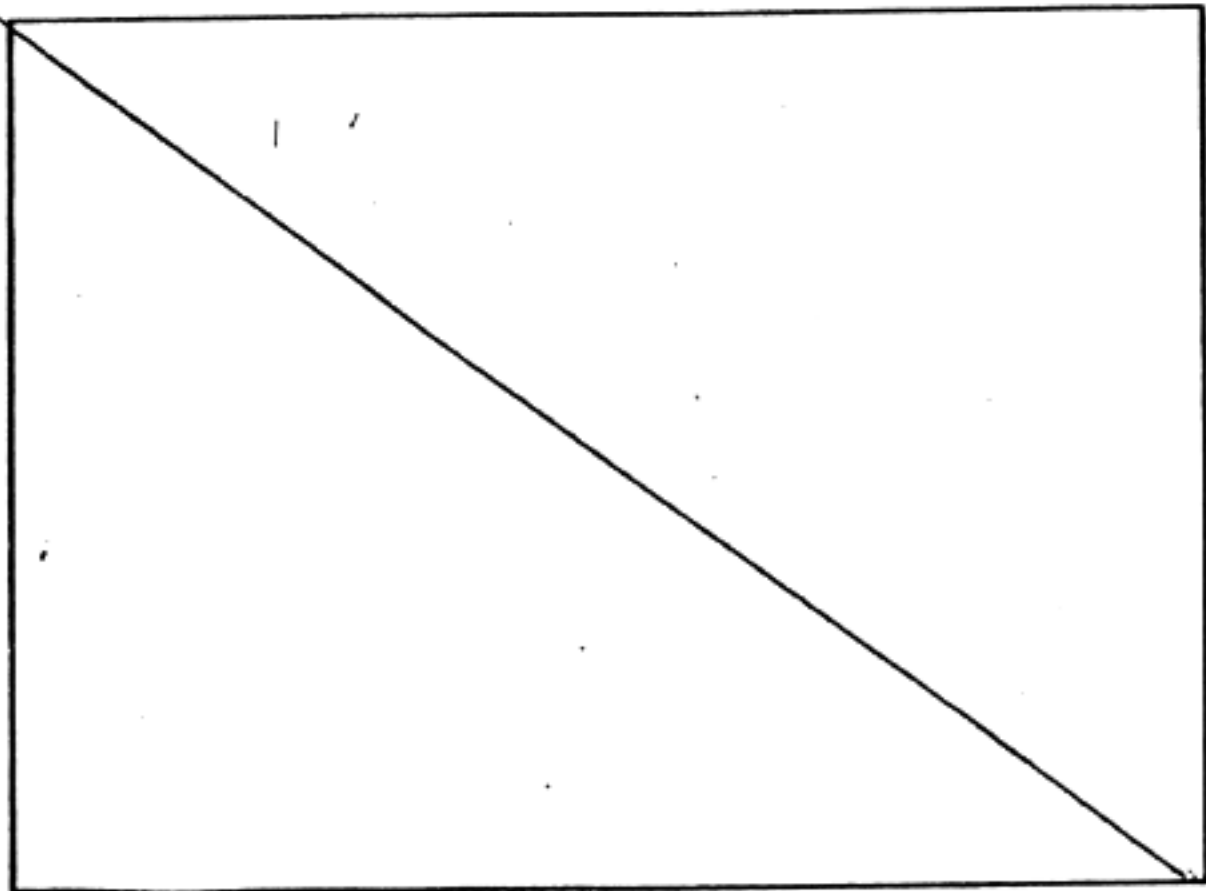

L.S. PRIME. AS HE RECEIVES THE FULL IMPACT OF THE BOLT STUNNING HIM!

221

PAN →



CUI CHIP, SPIKE, SPARK PLUG. AS THEY REACT WITH STUNNED DISBELIEF.

223

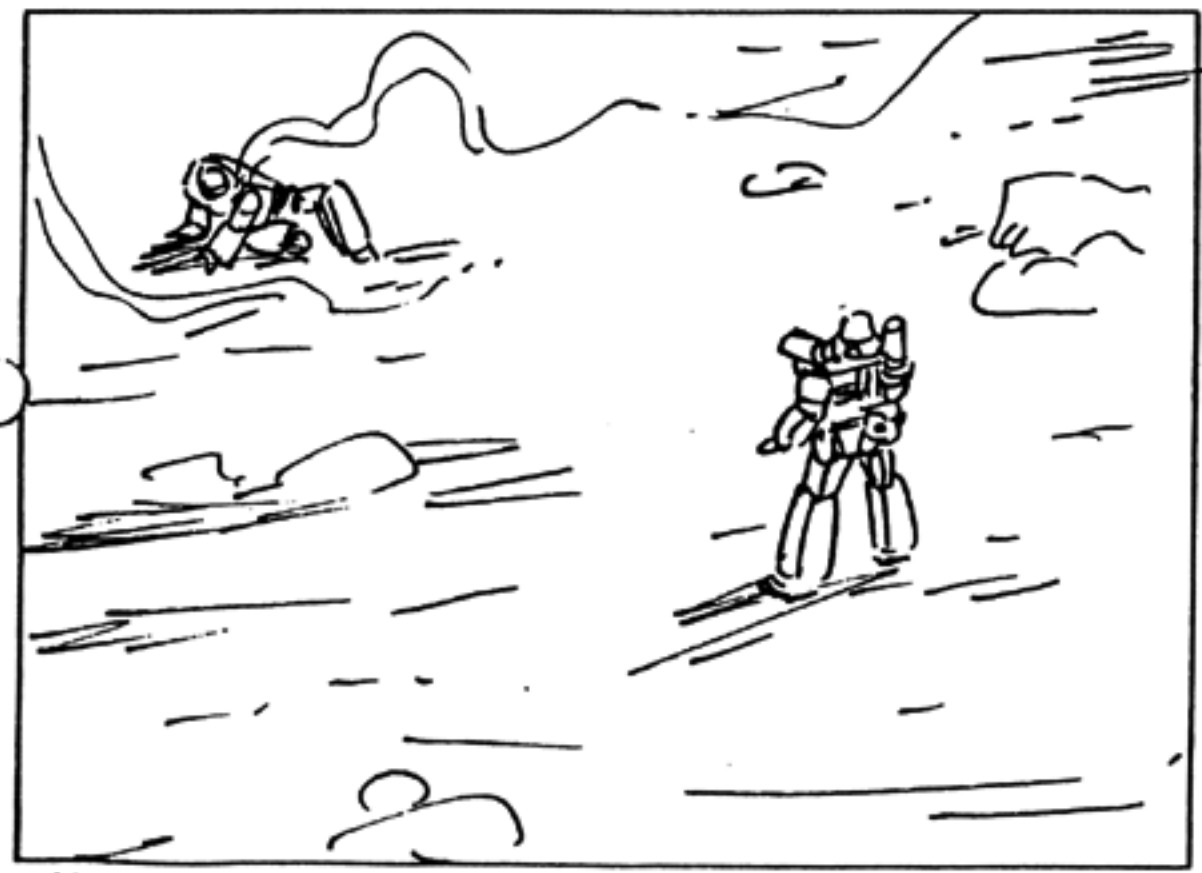

X-1'S, PRIME & MEGATRON. PRIME RECOVERES FROM THE HIT...

CONT

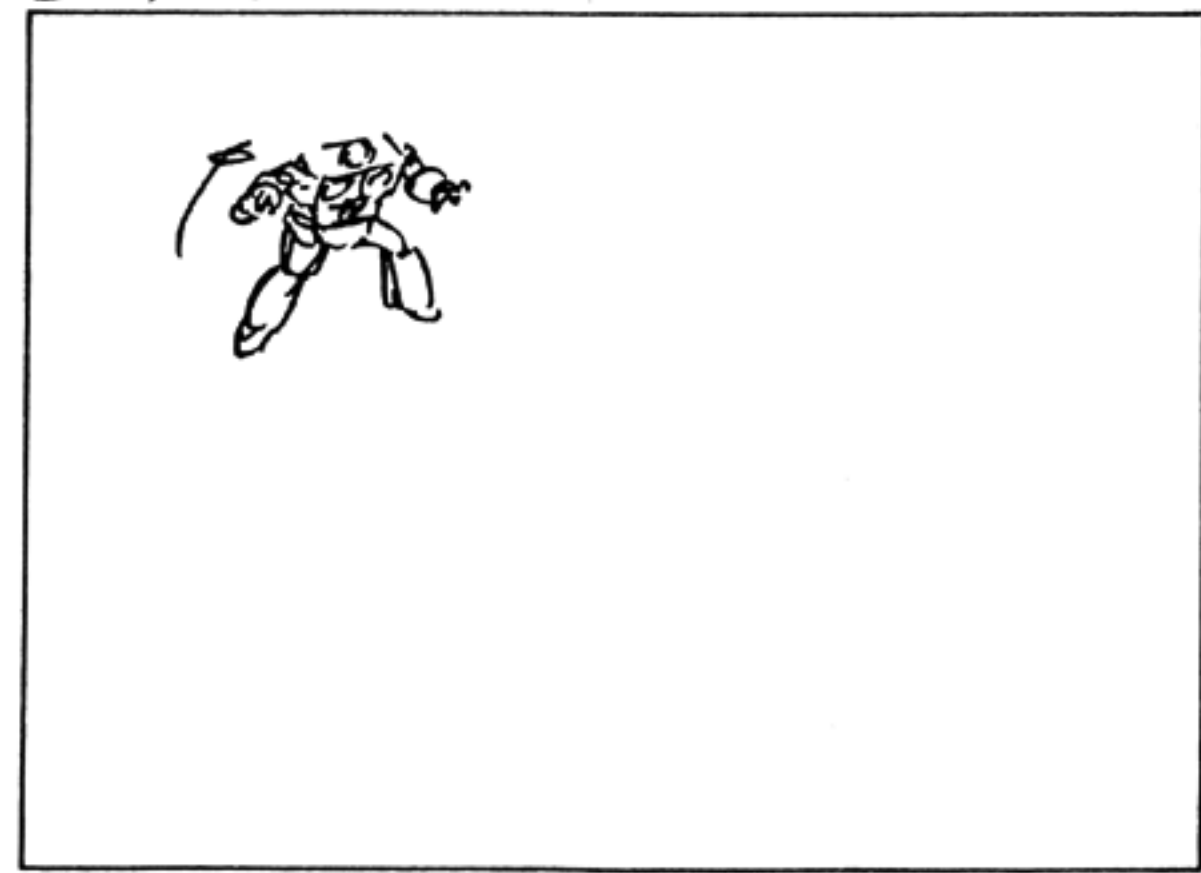

... GETS UP ...

222

700-13

73

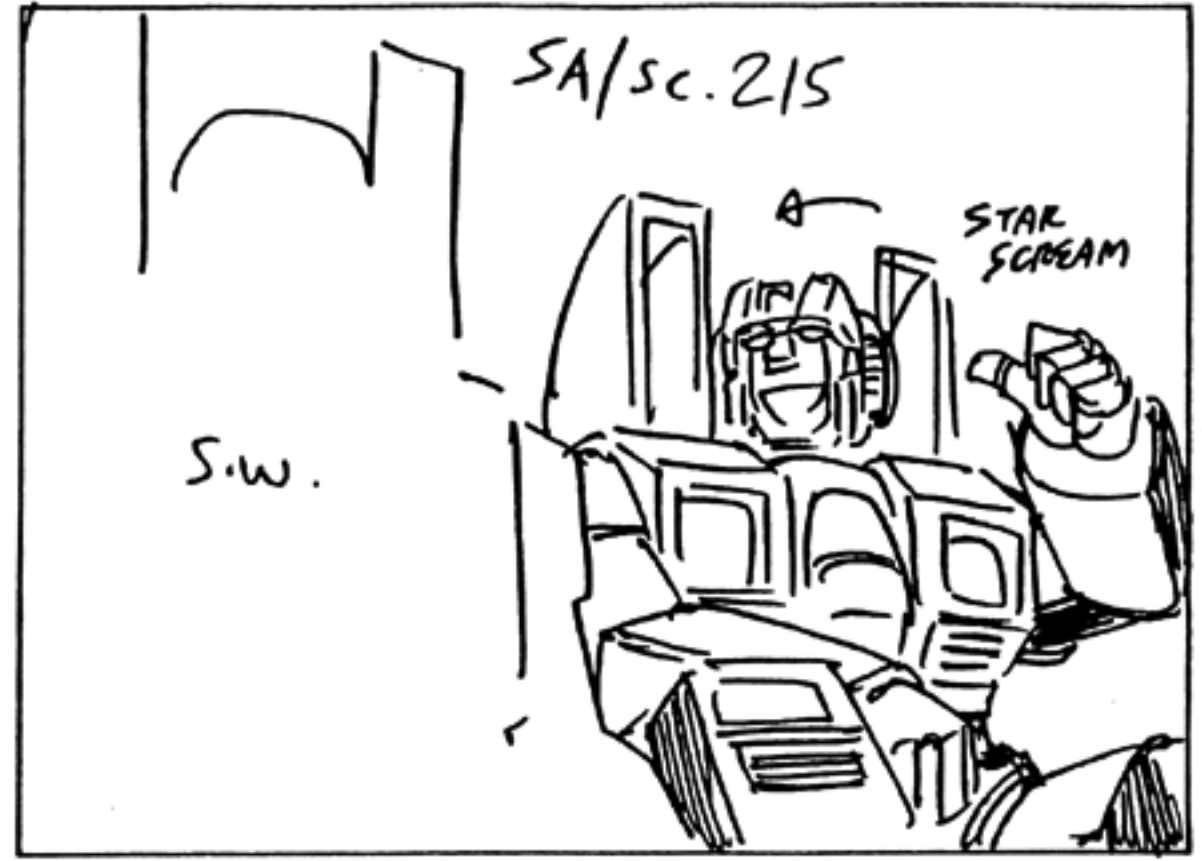

MS. SKYWARP & STARSCREAM. STARSCREAM: AND THE USE OF MY NULL-RAY TOO.

CONT

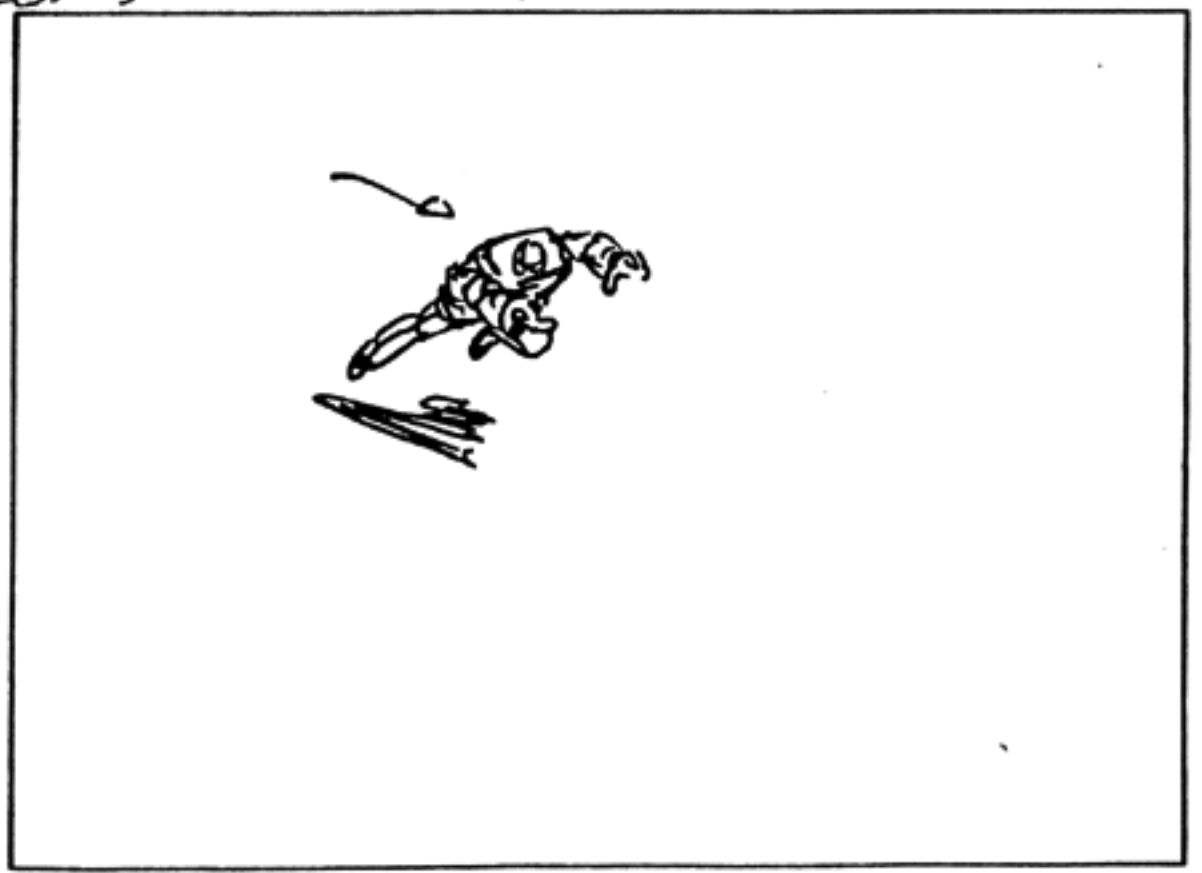

... AND RUSHES MEGATRON!

224

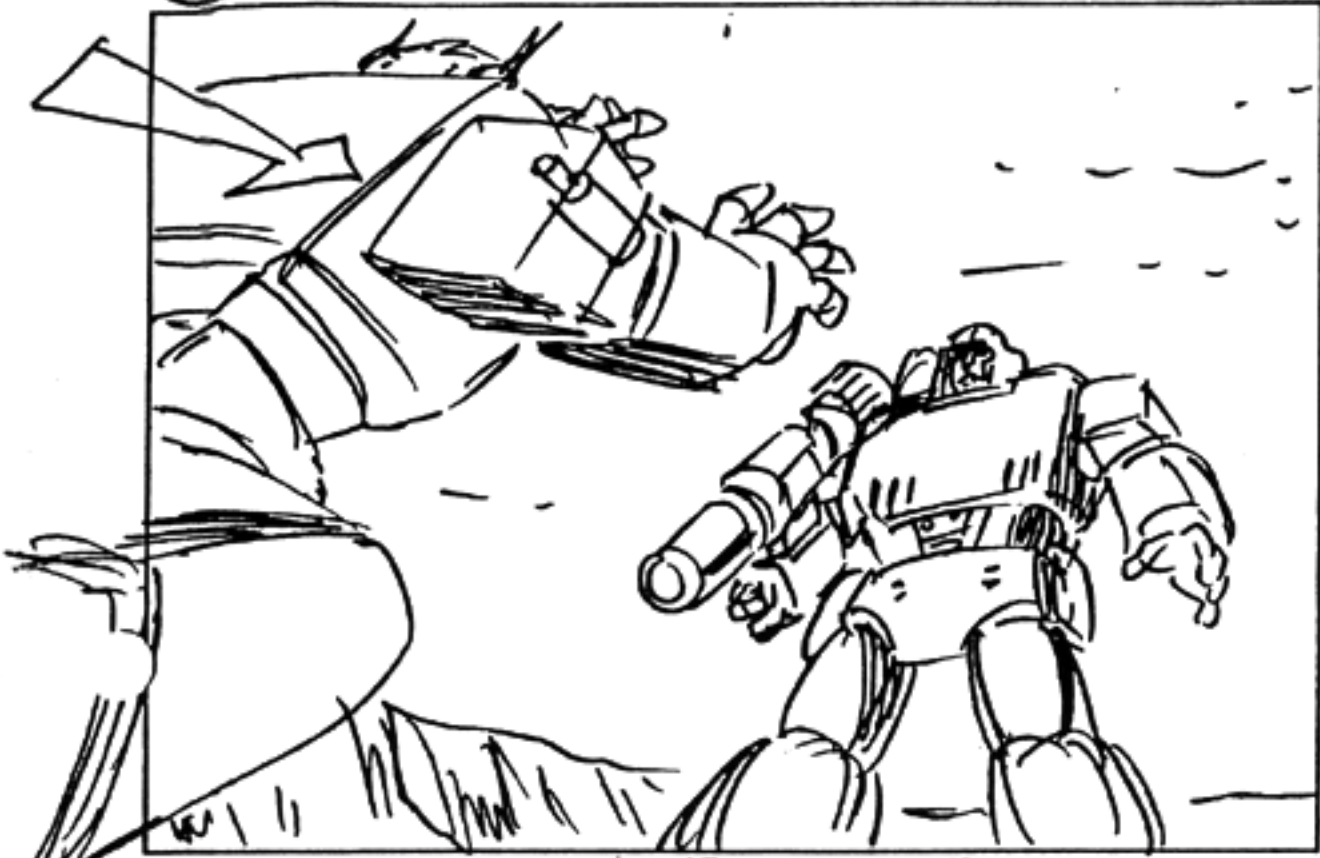

M.S. MEGATRON & PRIME PRIME REACHES OUT FOR MEGATRON...

CONT

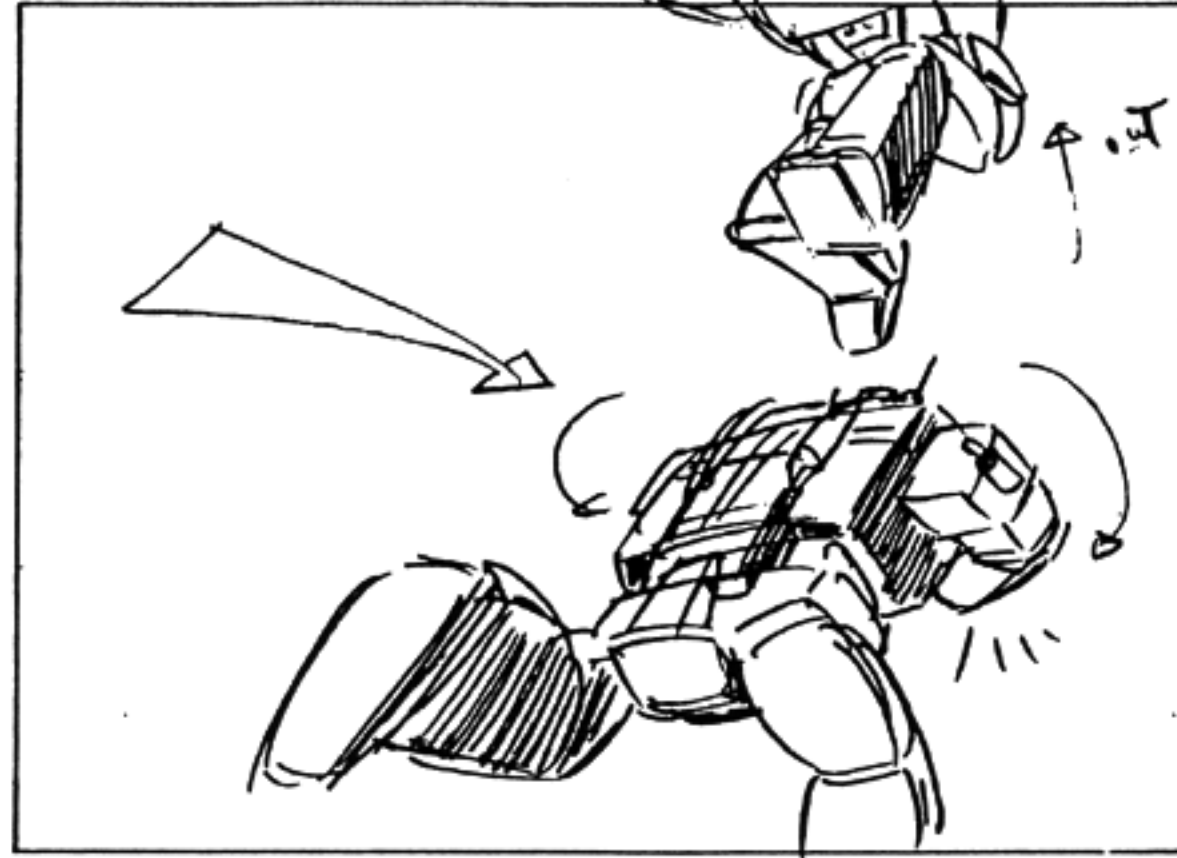

... BUT MEGATRON LEAPS UP OUT OF HIS GRASP.

CONT

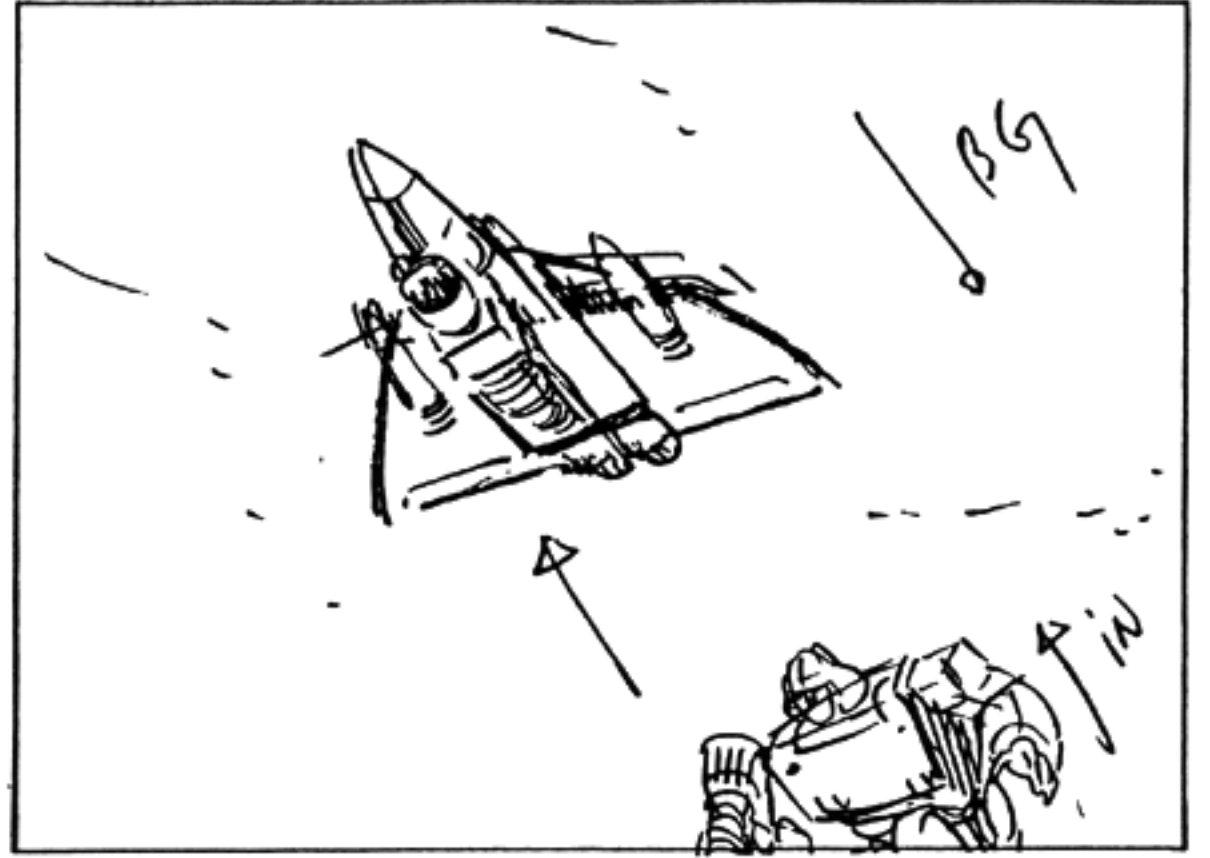

M.SHOT MEGATRON TO D.S. PRIME'S DISBELIEF TRANSFORMS INTO A JET FIGHTER PLANE.

225

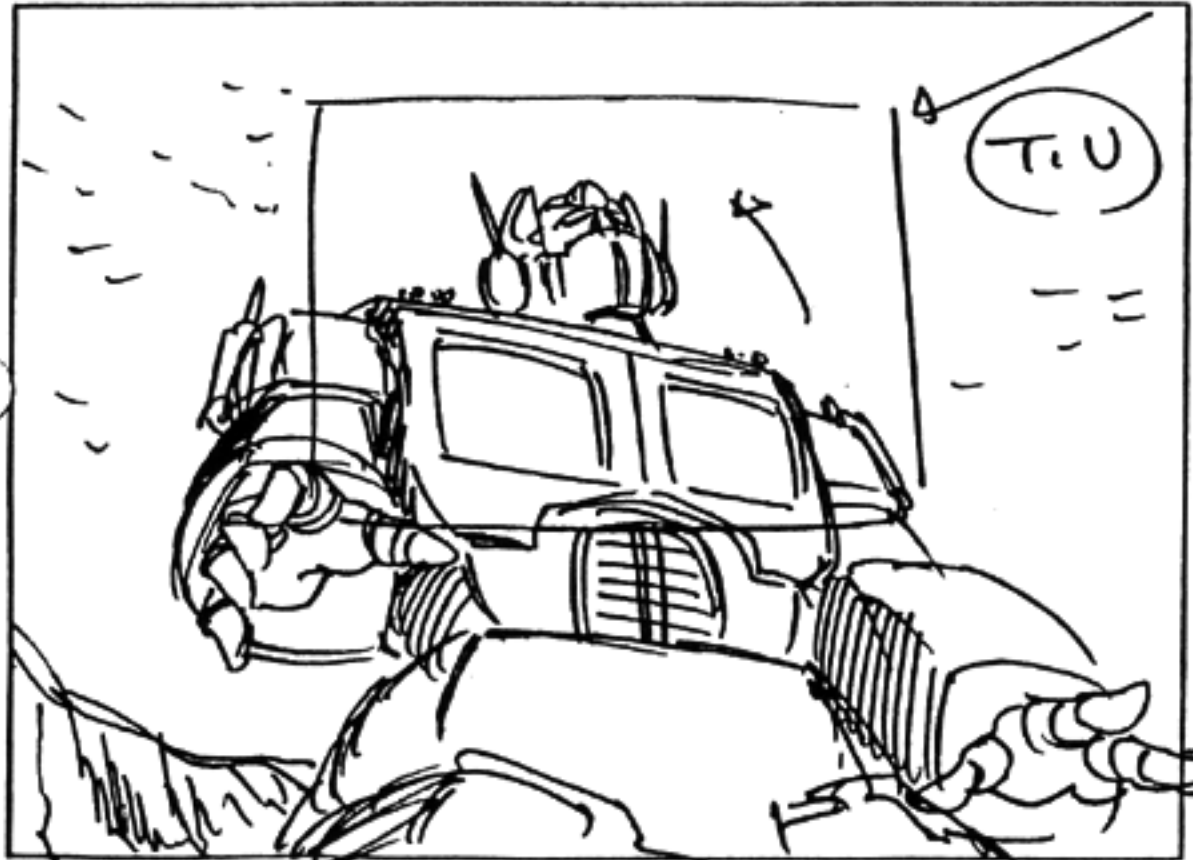

M.C.V. PRIME (LOOKS SKYWARD INCREDULOUSLY) HE NEVER DID THAT BEFORE!

226

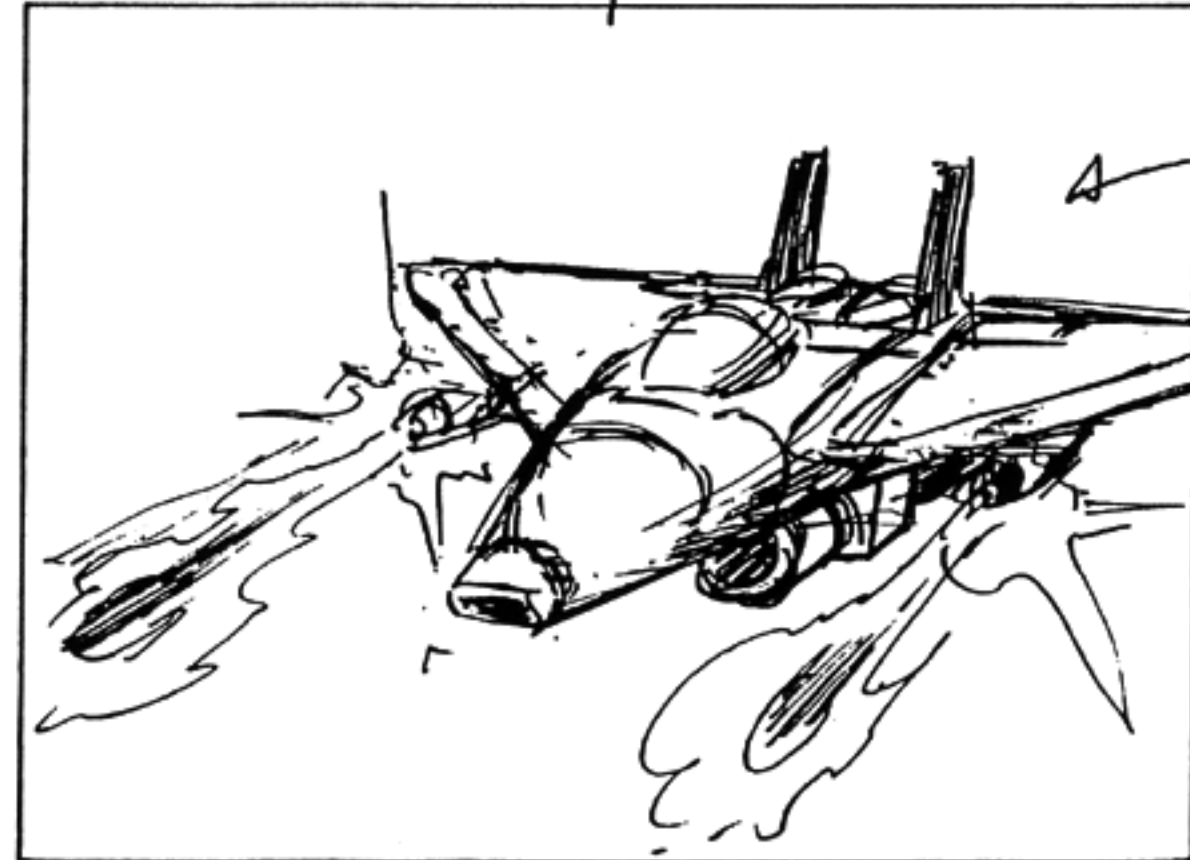

M.L.S. CAMERA PANS AS JET ZOOMS AROUND THEN ARCS IN THE AIR TO FIRE DRONE ROCKETS PAST CAMERA.

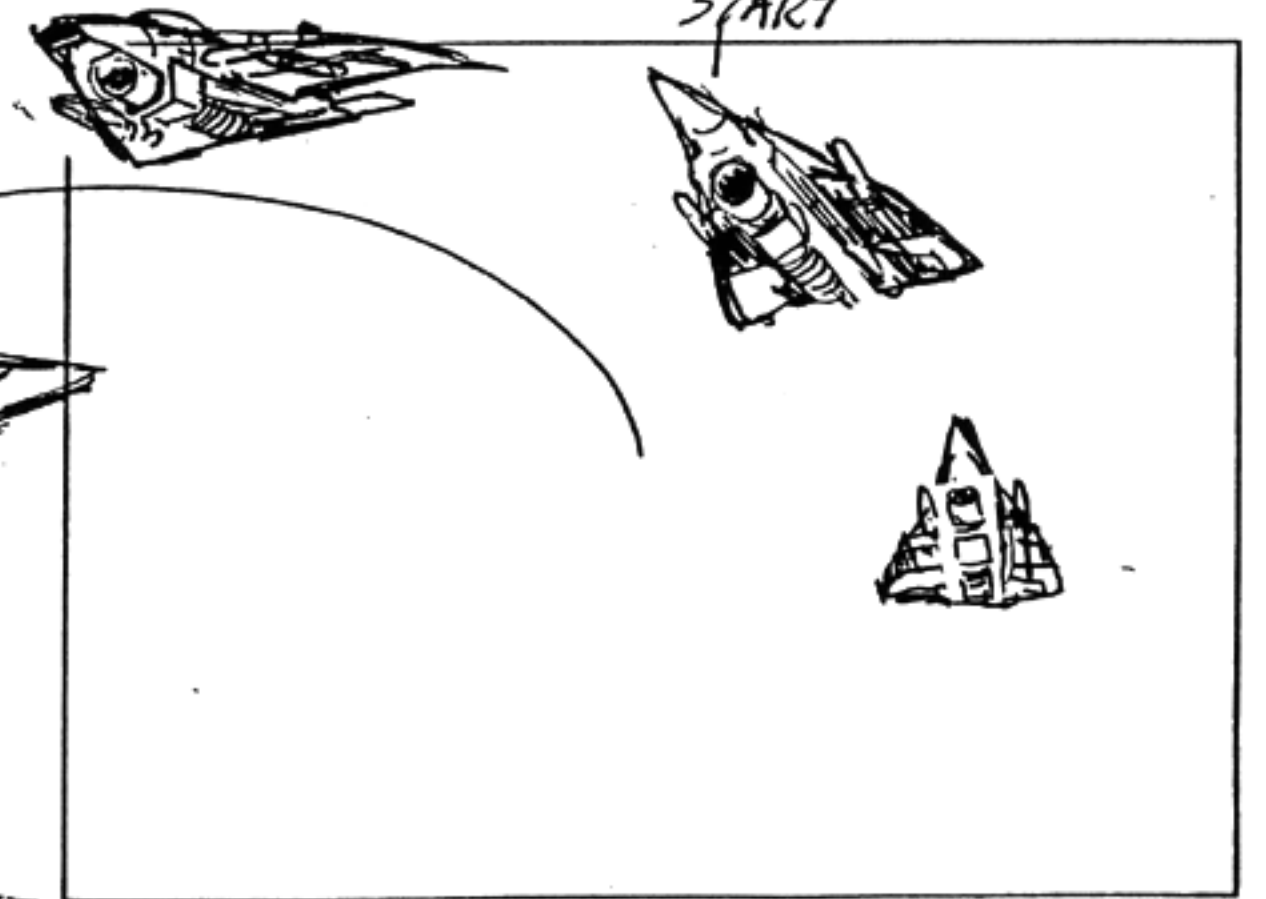

227



L. DOWN SHOT PRIME SEES ROCKETS COMING

CONT

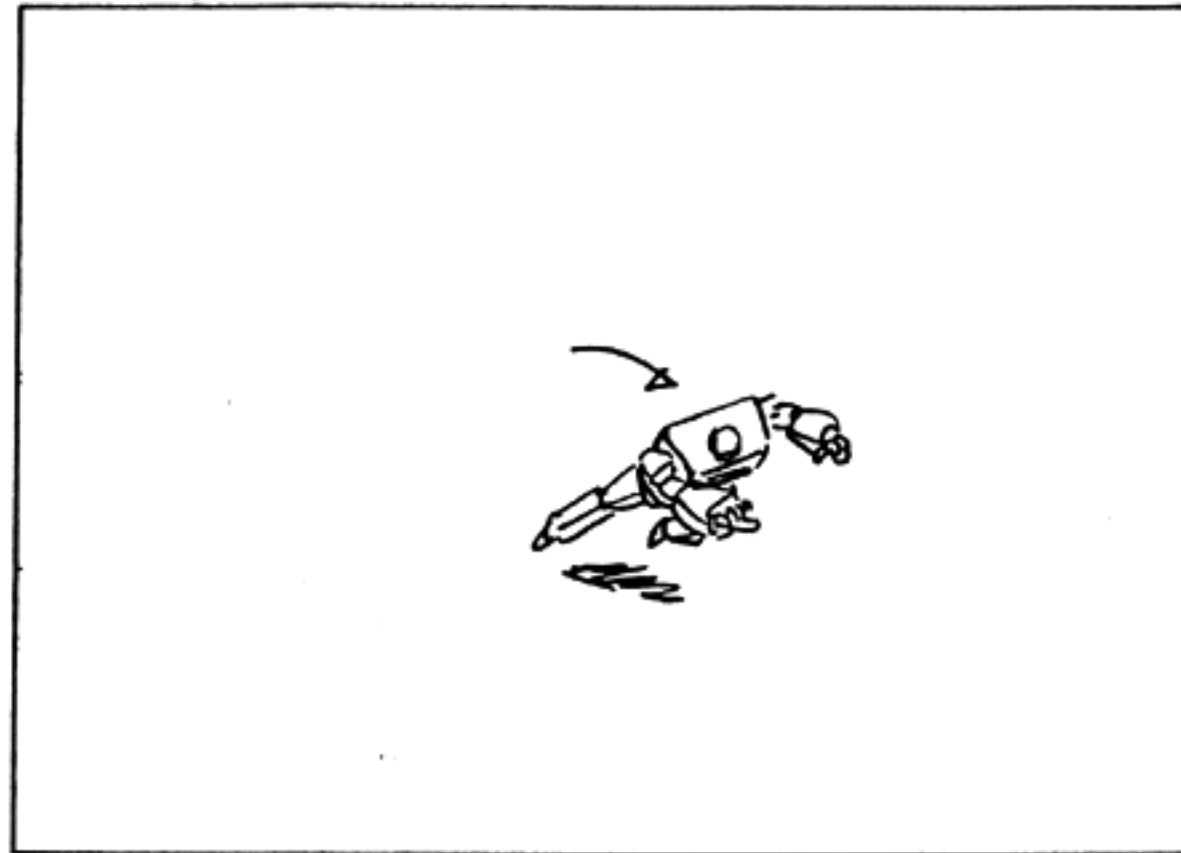

AND TRIES TO EVADE THEM AS THEY EXPLODE AROUND HIM BLASTING ROCKS APART,

CONT

700-13

75



CONT



PRIME RECOVERS

228

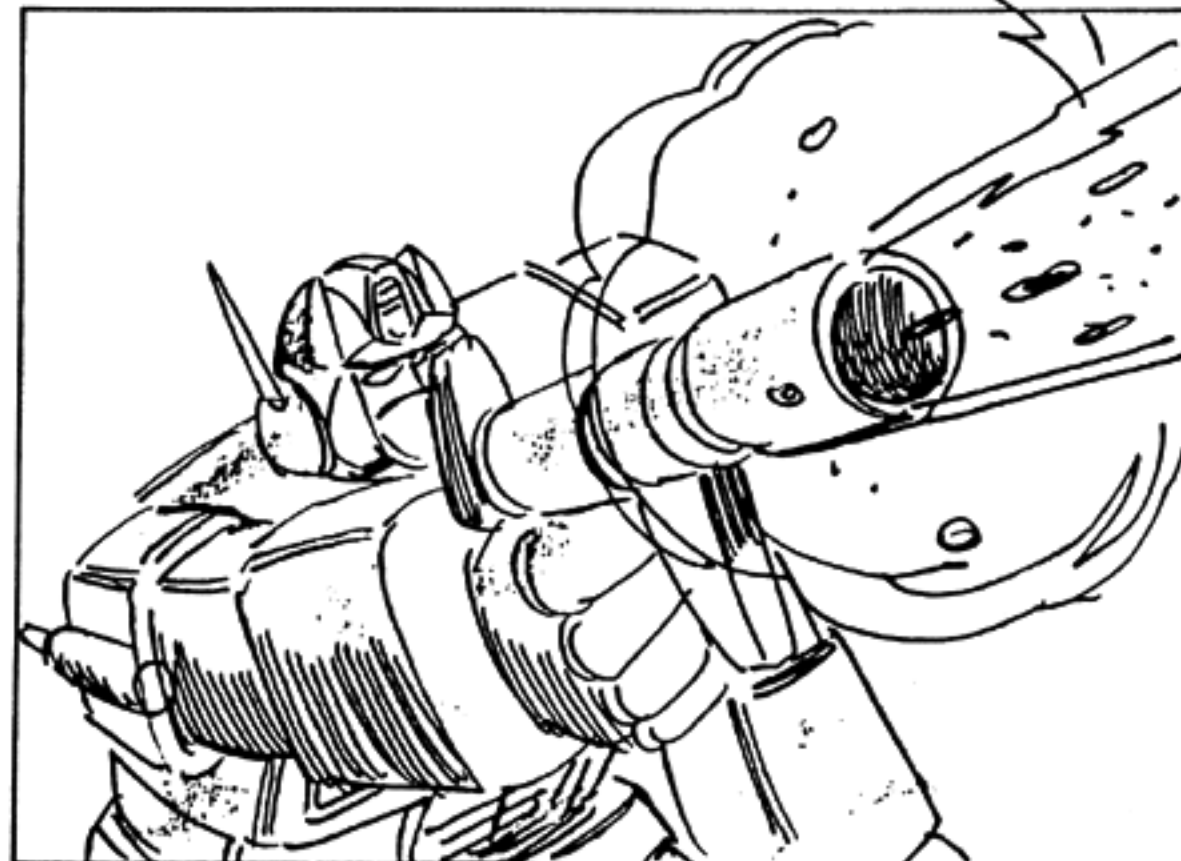

M.C.U. PRIME RAISES HIS LASER GUN AND FIRES AT THE O.S. MEGATRON JETPLANE.

229

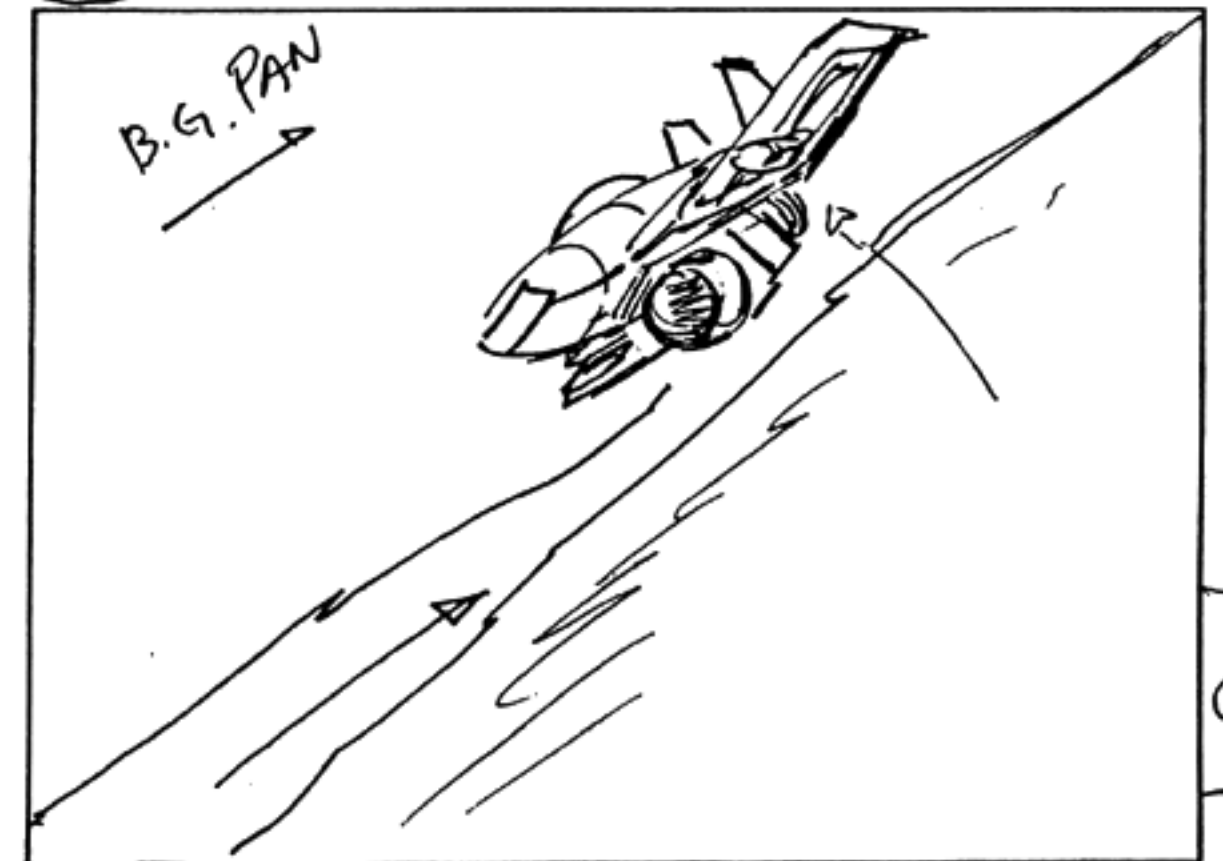

M. SHOT MEGATRON JET EVADES PRIMES LASER BEAMS

CONT

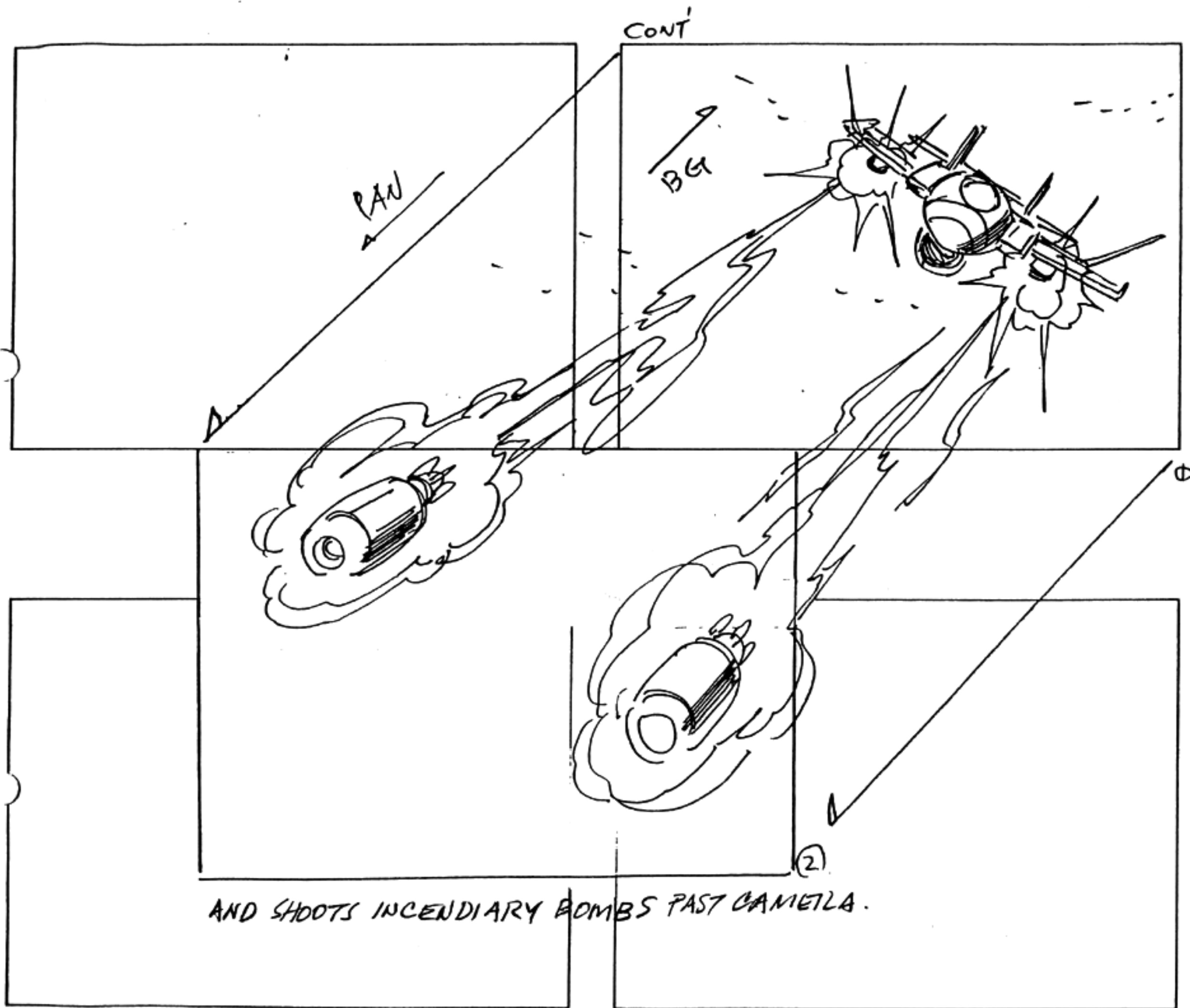

AND SHOOTS INCENDIARY BOMBS PAST CAMELA.

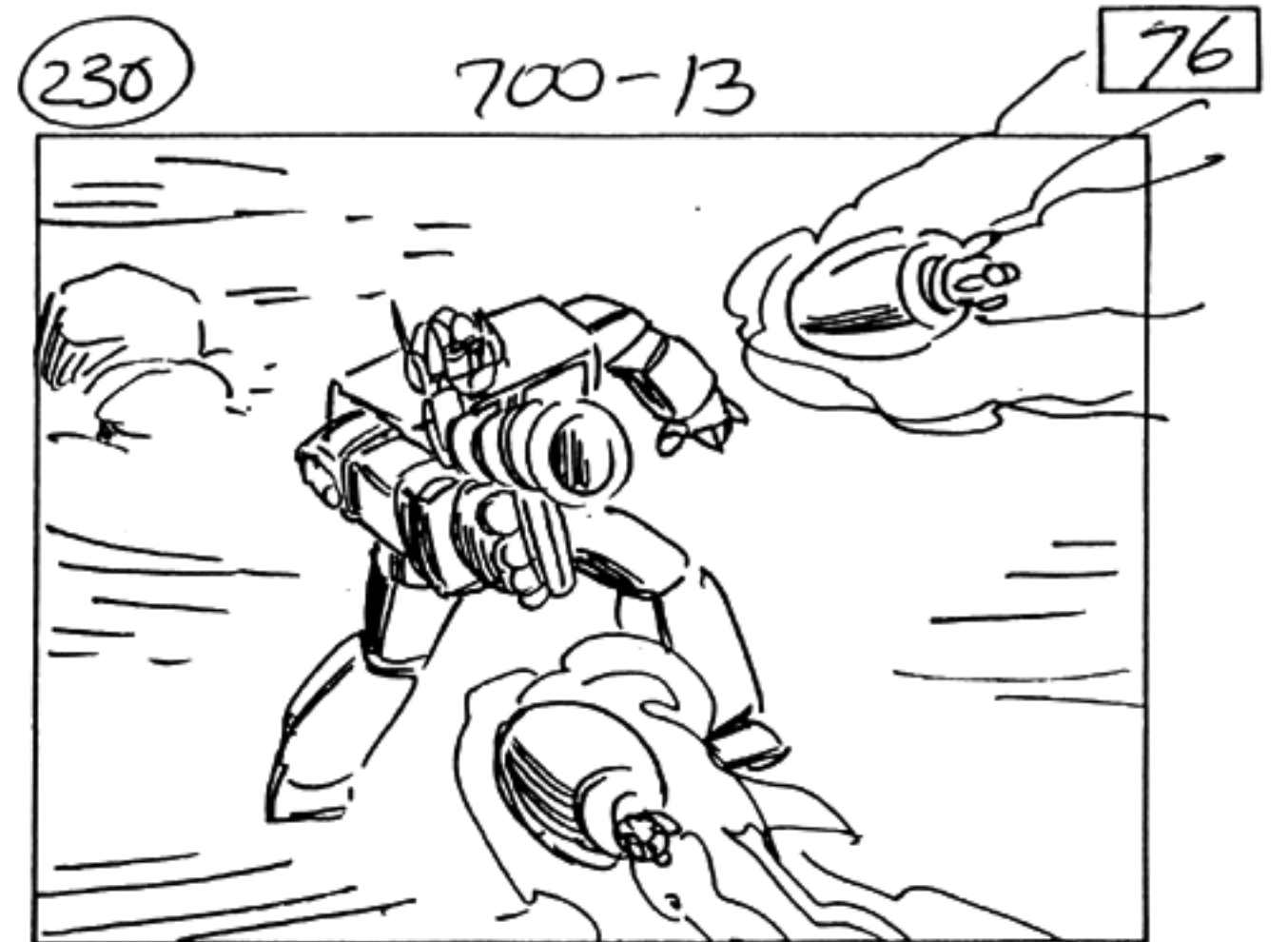

MR. DOWN SHOT PRIME TRYING TO GET JETPLANE IN HIS SIGHTS AS INCENDIARY BOMBS ZOOM IN

↓  
CONT



BOMBS EXPLODE OFF HIS HIDE CREATING BURSTS OF CRACKLING FIRE

231

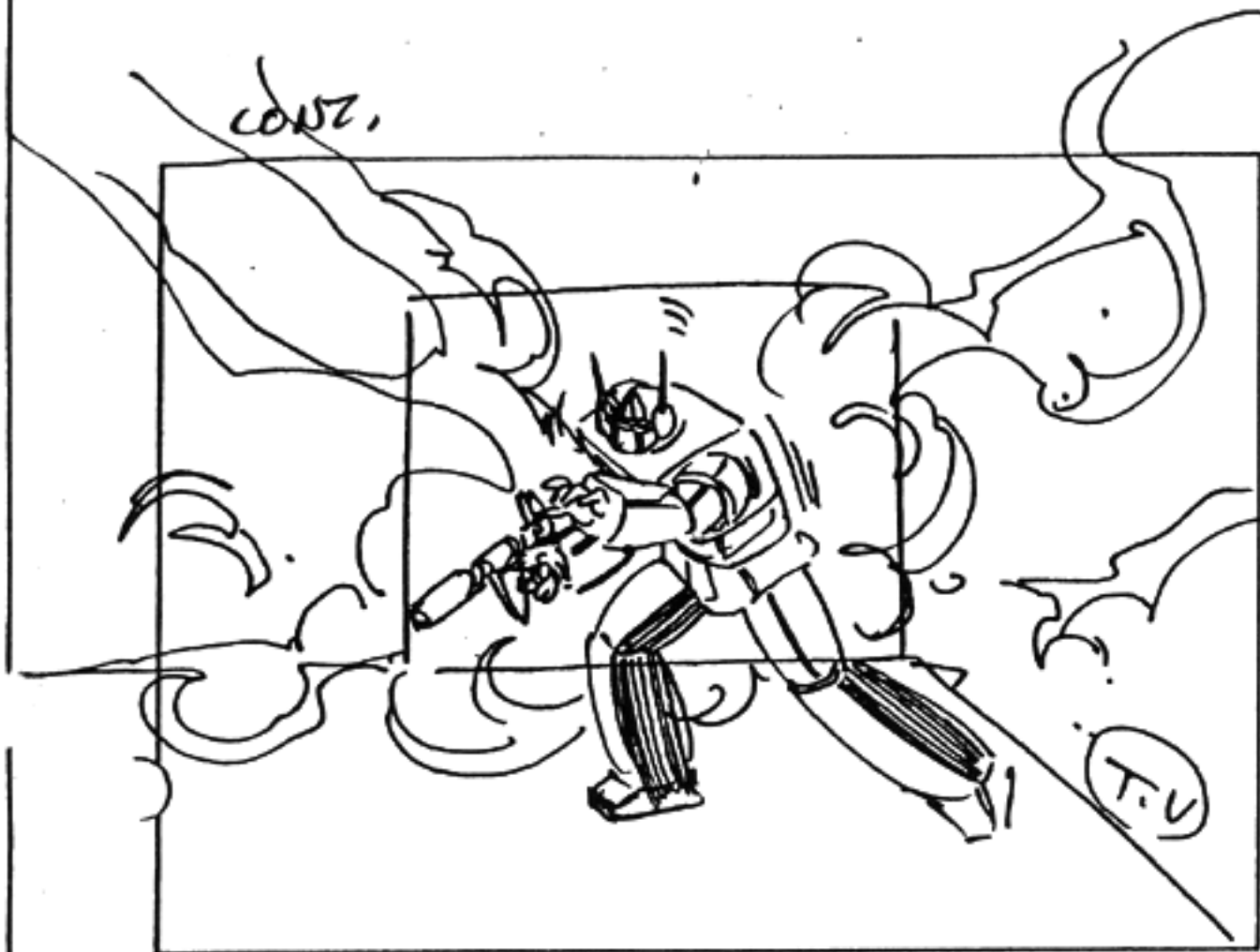

FORCING PRIME TO RETARD HIS LASER FIRE.

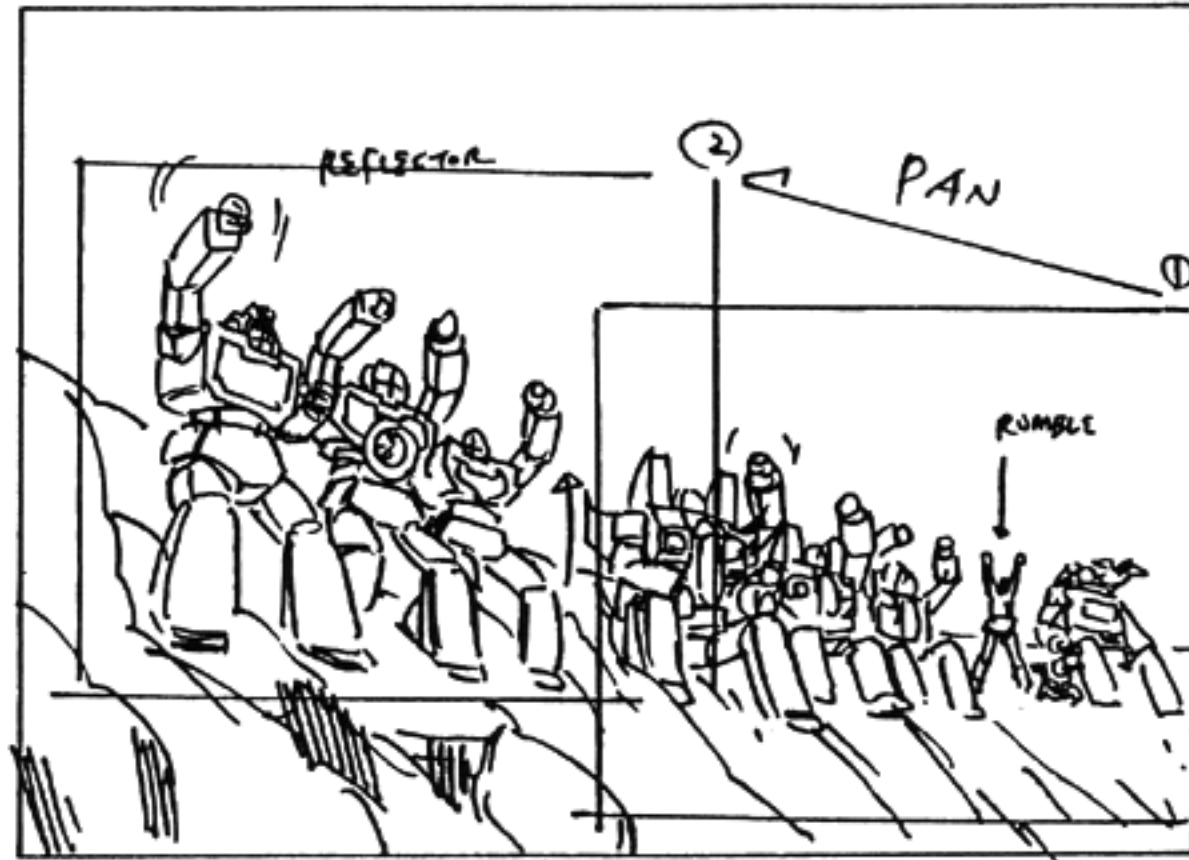

M.I.S. PAN ALONG LINE OF CHEERING DECEPTICONS (AD LIBBED CHEERS, YEAH MEGATRON ETC.)

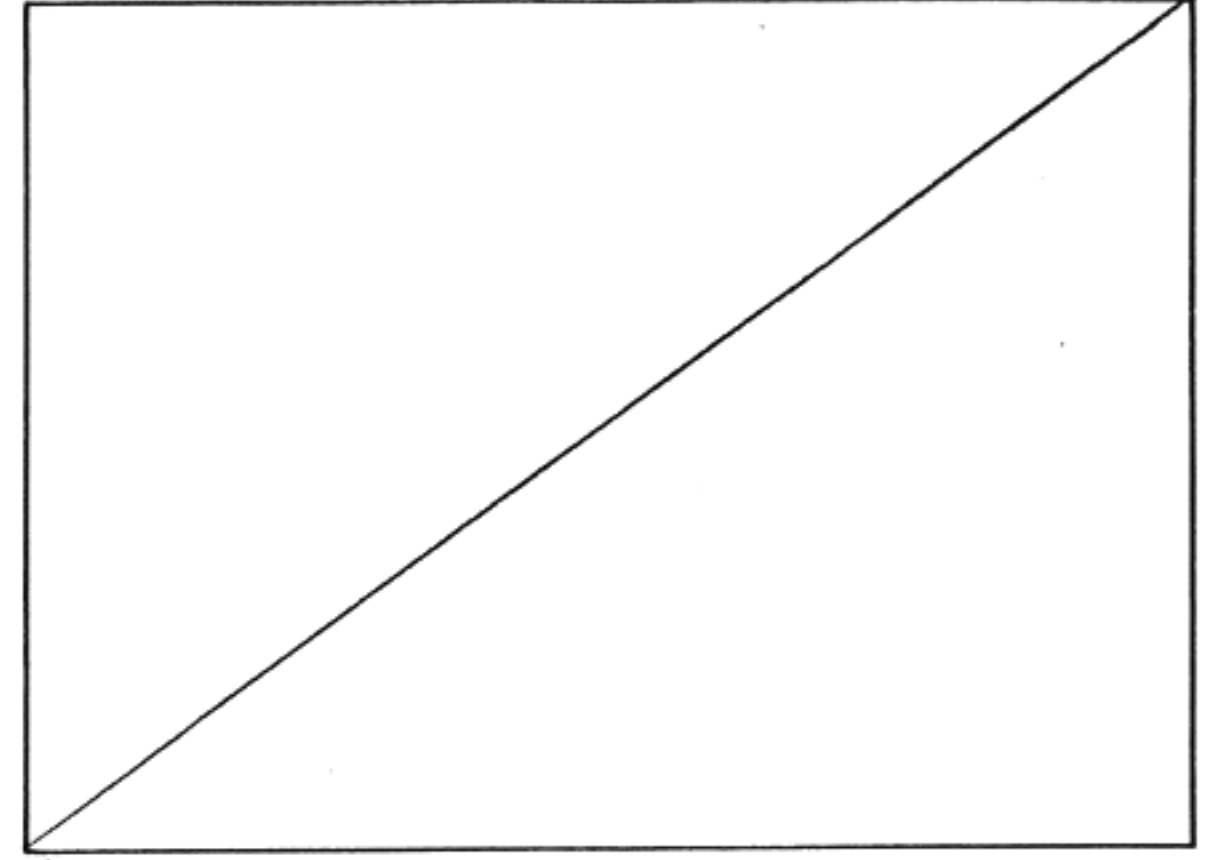

232

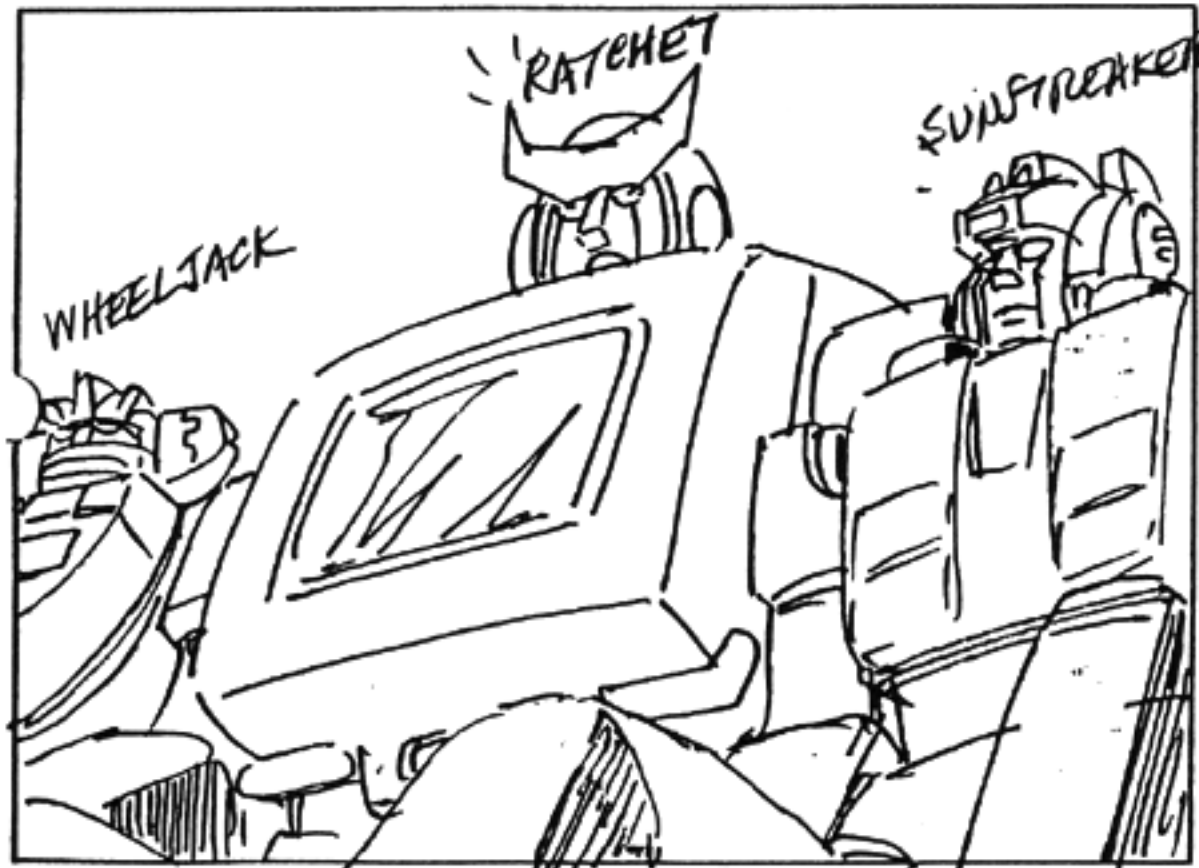

M.I.C. 3 SHOT (RATCHET BEWILDERED) THIS DOESN'T PRINT OUT RIGHT!

CONT

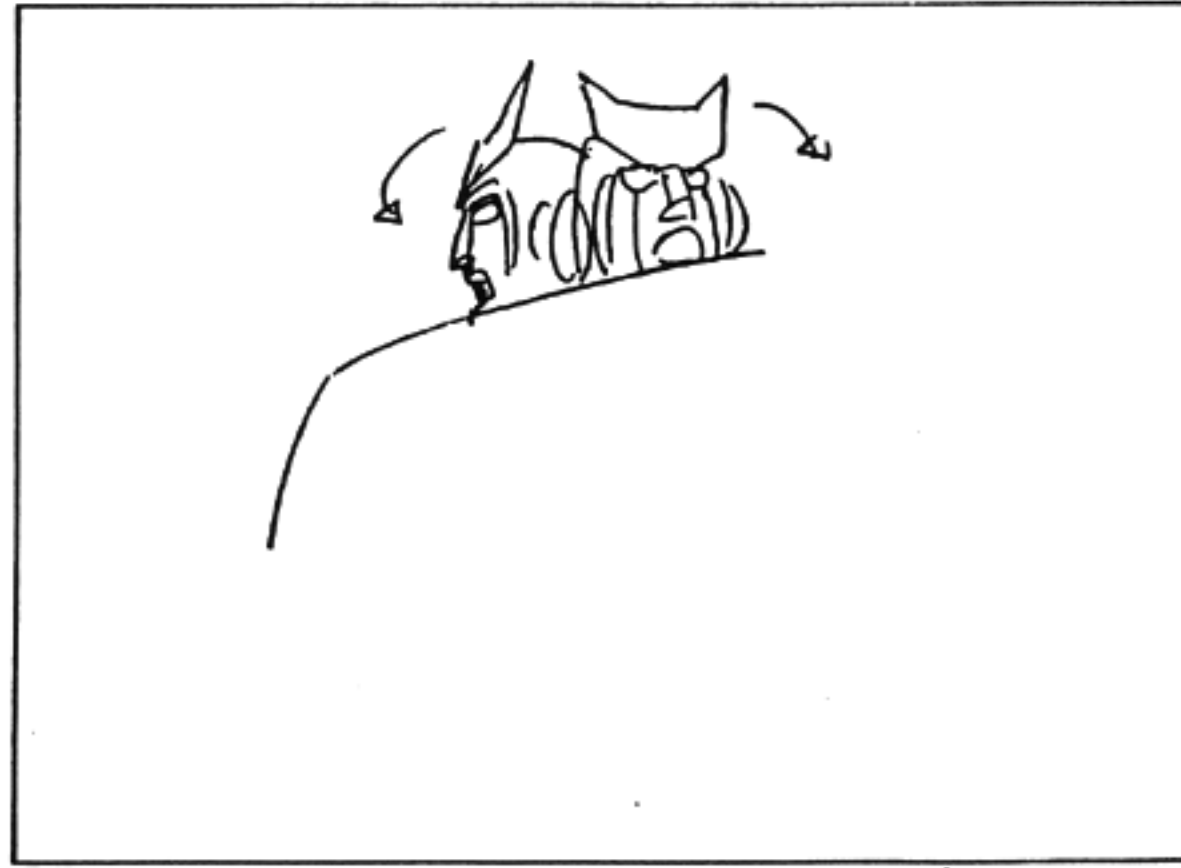

LOOKS AROUND QUESTIONINGLY HOW'D MEGATRON GET SO VERSATILE?

233

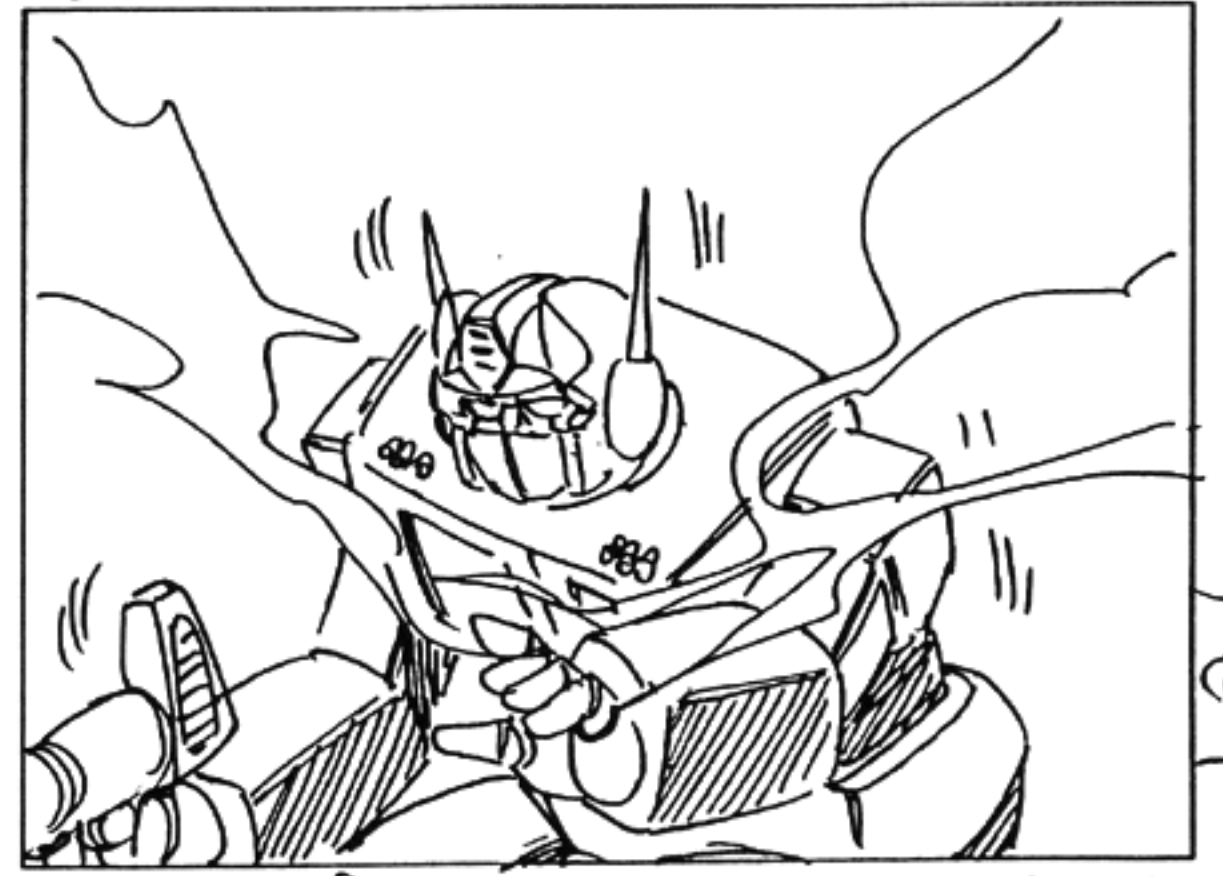

M.C. DOWN SHOT PRIME GETS UP DESPITE THE INCENDIARY BOMBS BURSTING OFF OF HIM

233  
CONT.

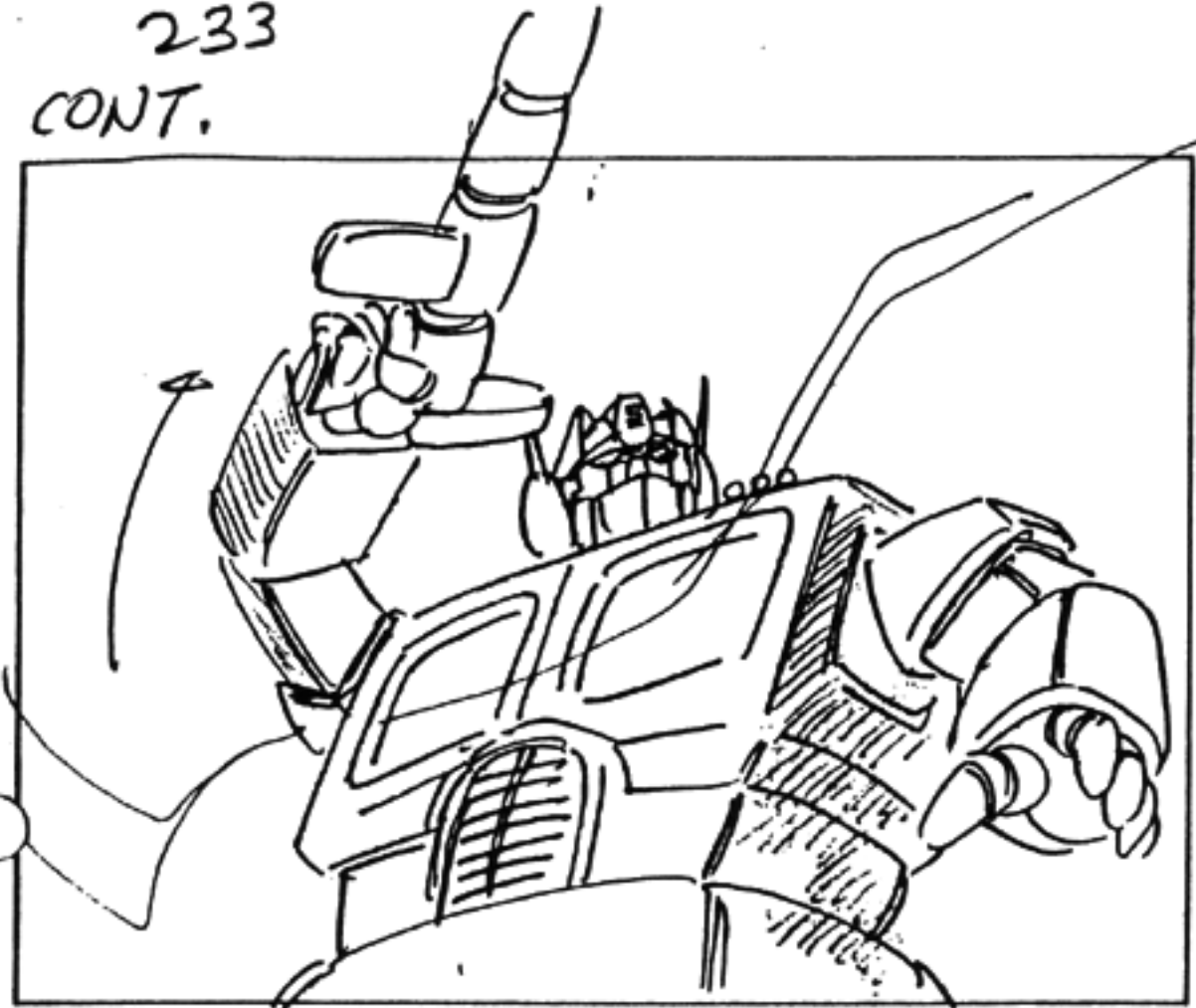

AND CONTINUES TO BLAST AWAY WITH HIS INCENDIARY GUN.

CONT

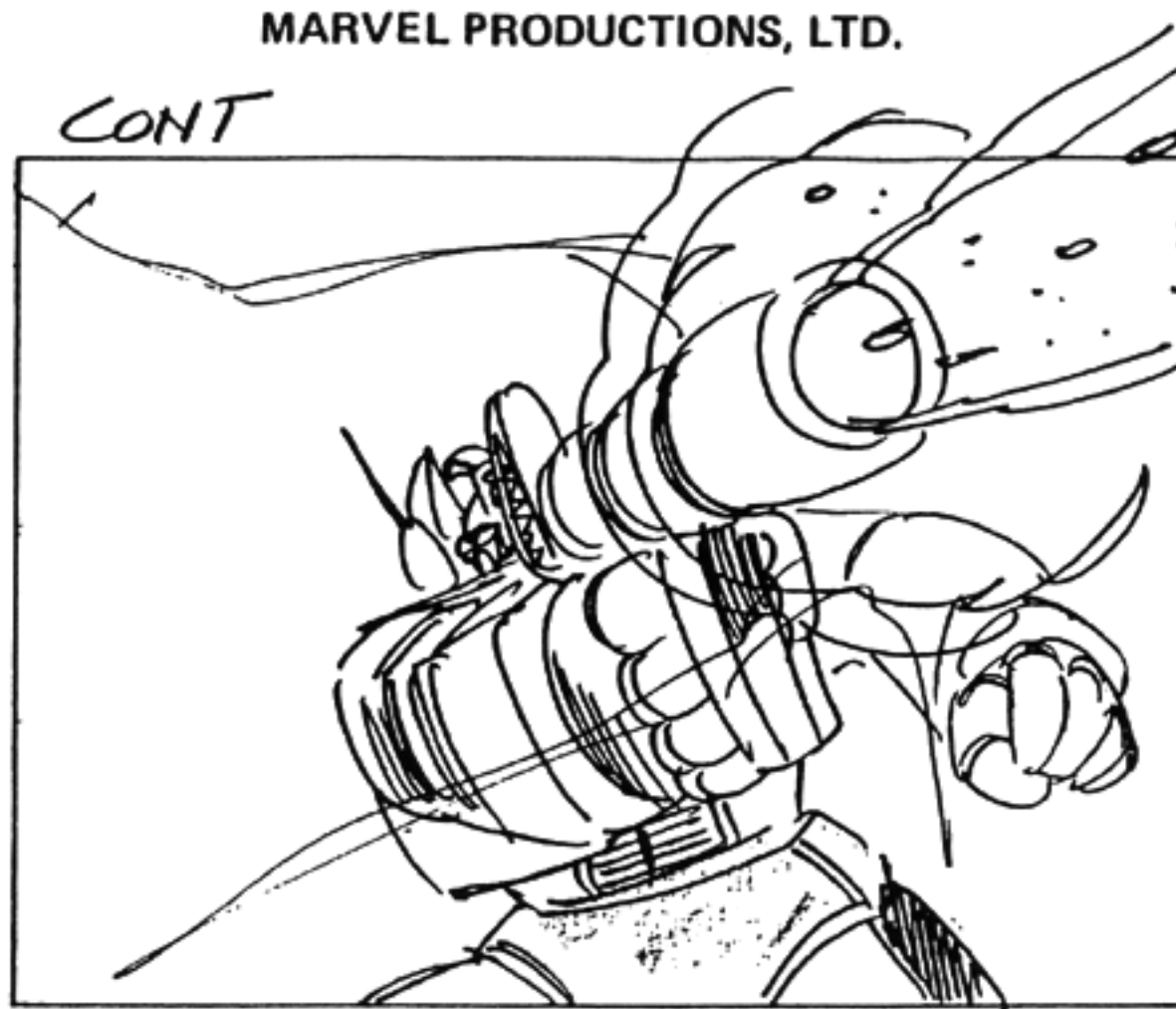

234

700-13

78



M.C. 2 SHOT SPIKE & SPARKPLUG WORRIED.  
SPARKPLUG: C'MON, OPTIMUS! YOU CAN DO IT!

235

PAN



CAMERA  
TILT

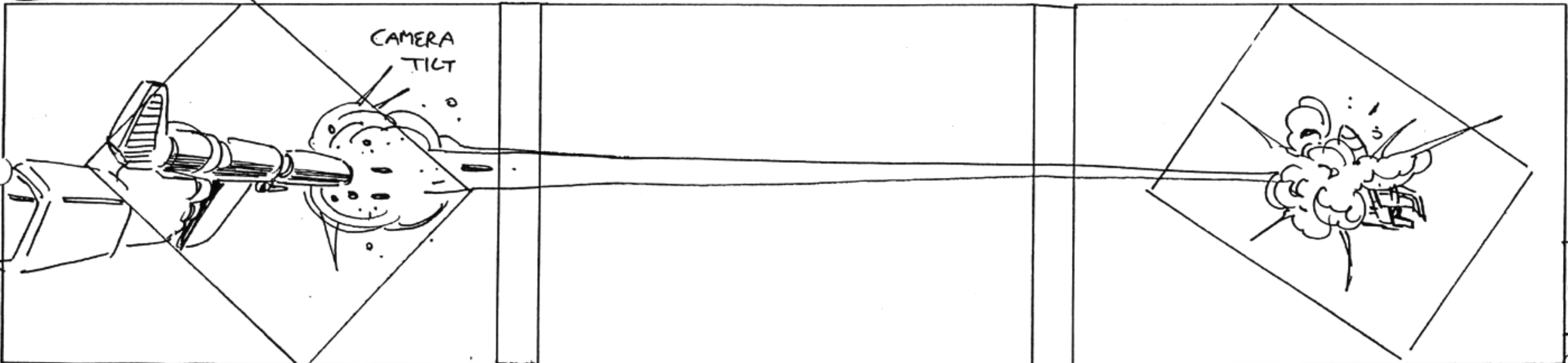

C.U. PRIMES RAYGUN PAN WITH LASER FIRE

TO FLYING JET, ZAPPING ITS HULL

CONT.

230,  
CONT

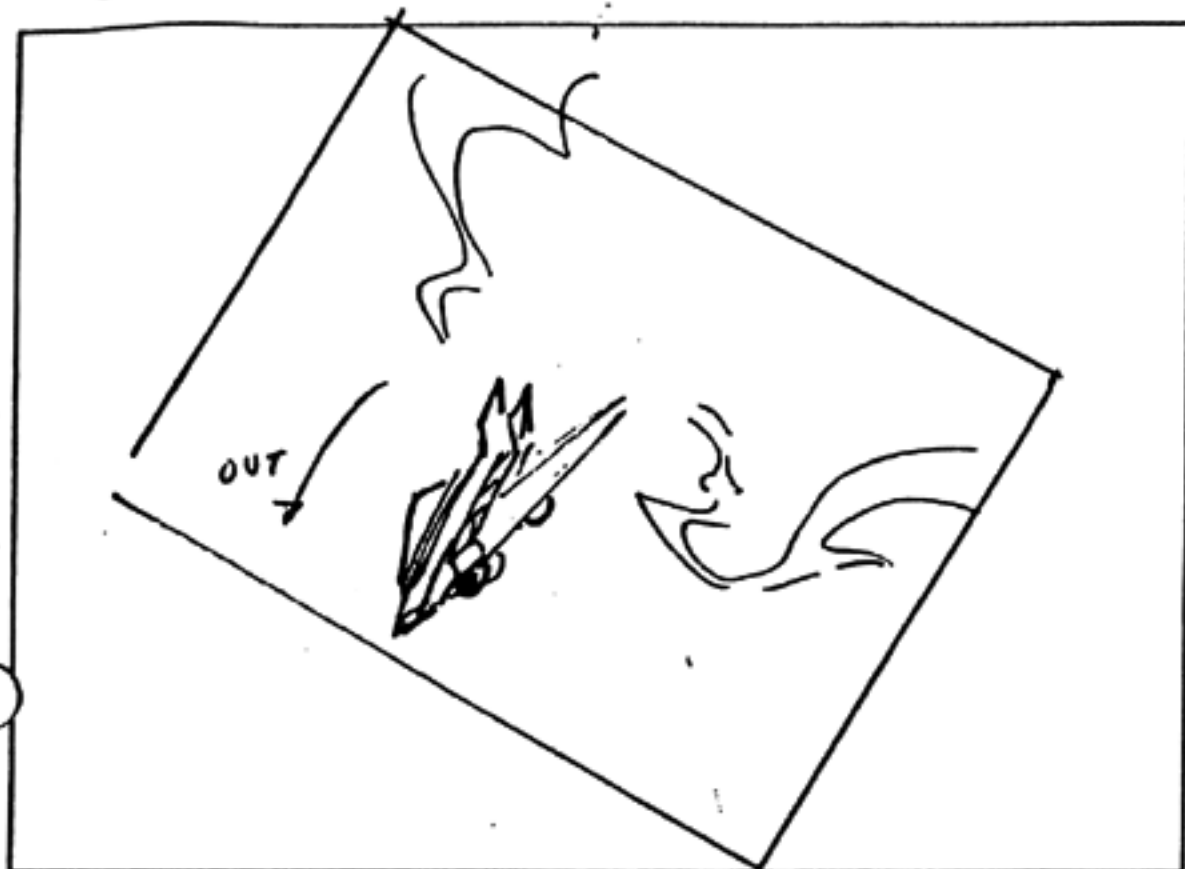

AND FORCING IT EARTHWARD.

MARVEL PRODUCTIONS, LTD.

231

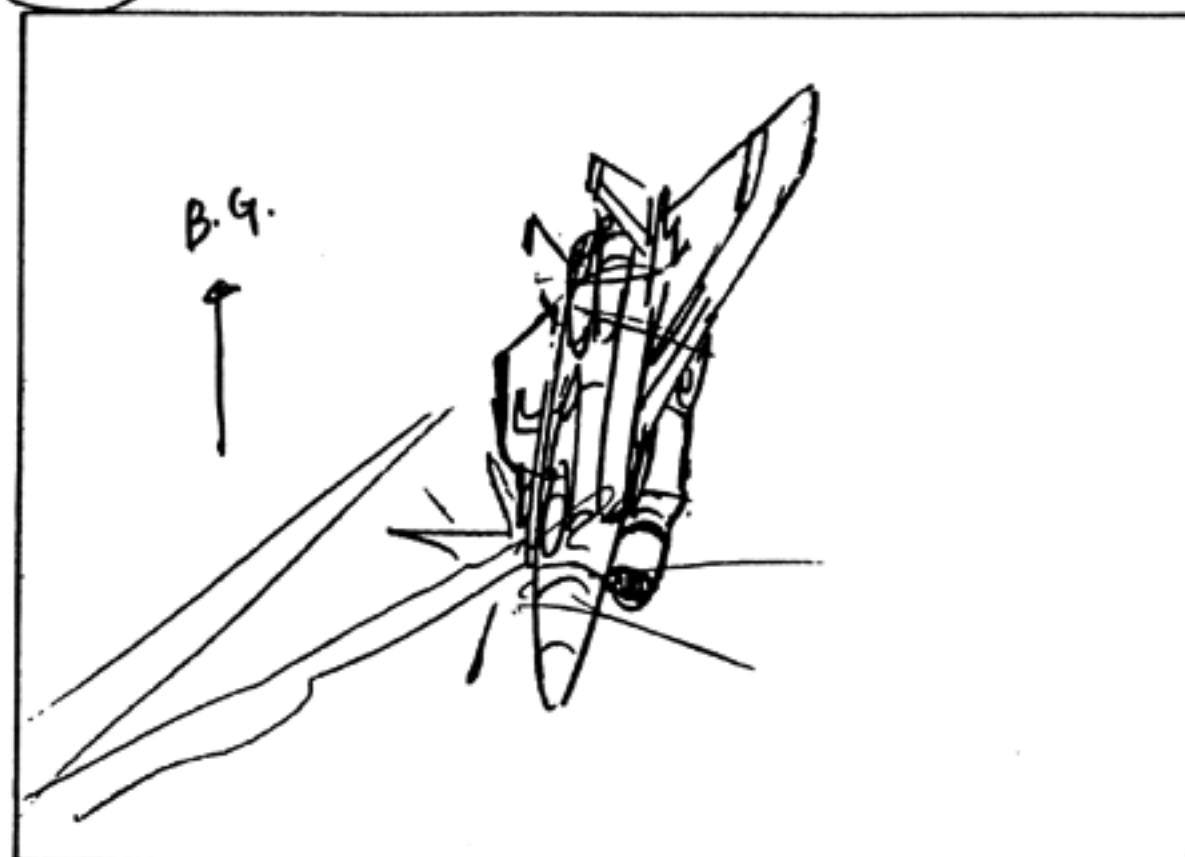

M. SHOT DIVING SET PLUNGING EARTHWARD TRANSFORMS TO MEGATRON  
(LASERRAYS STILL EXPLODING OFF IT.)

CONT

700-13

79

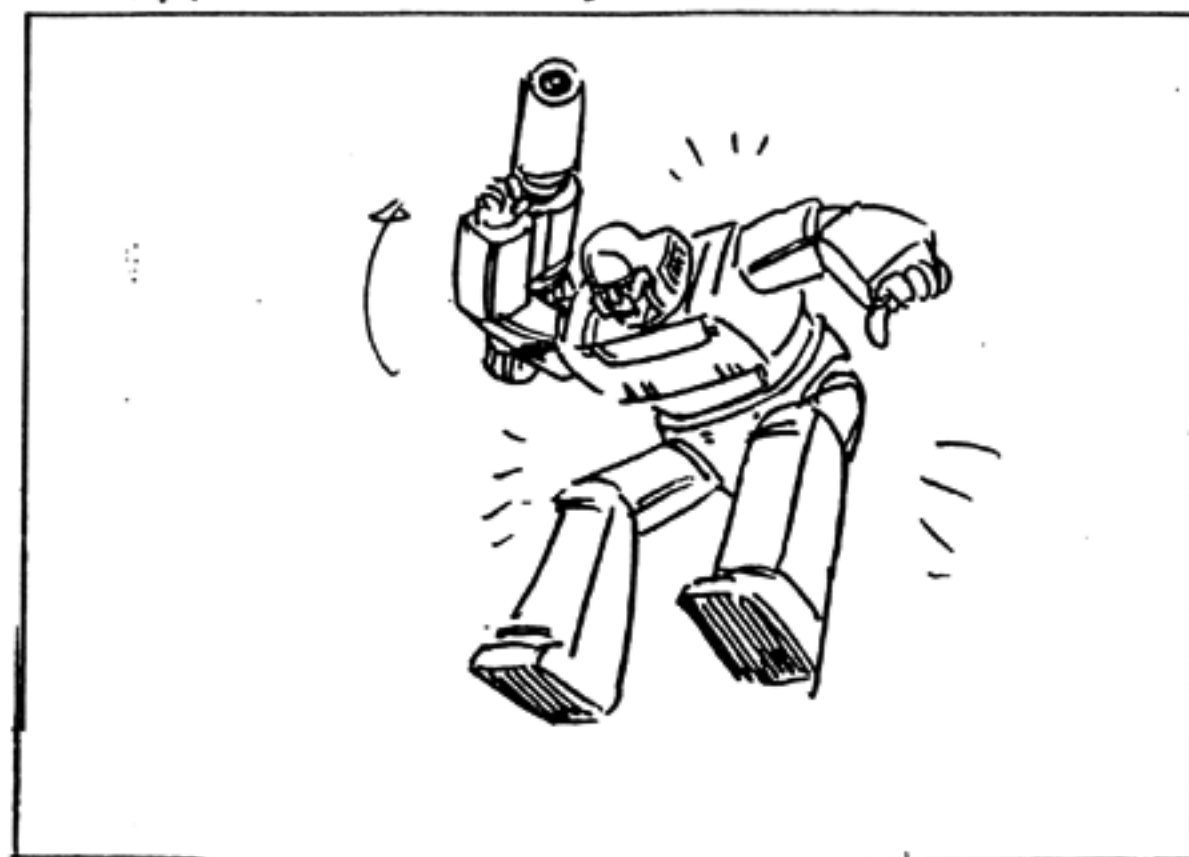

CONT.

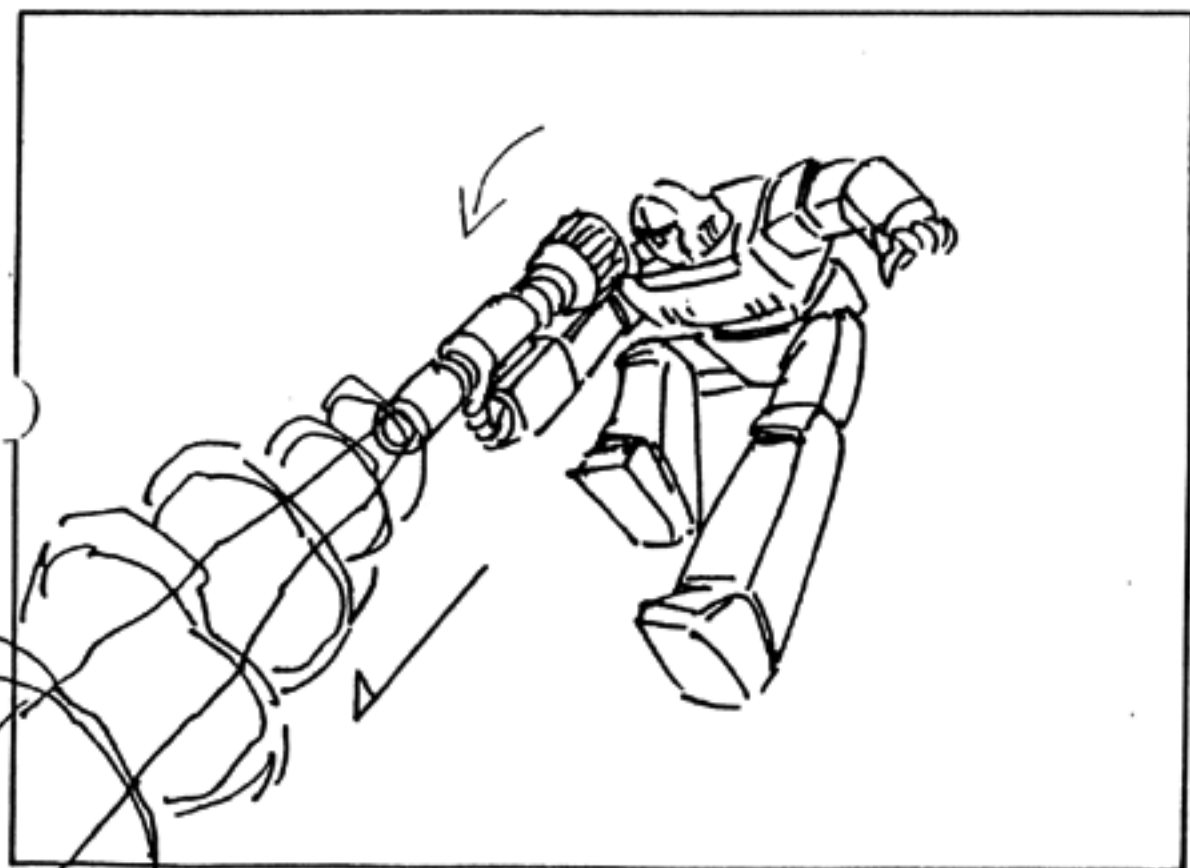

WHO AIMS HIS FUSION CANNON AND SHOOTS  
AN UNDULATING ENERGY WAVE. O.S.

232



C.U. ENERGY WAVE PULSATING TOWARD  
EARTH.

233

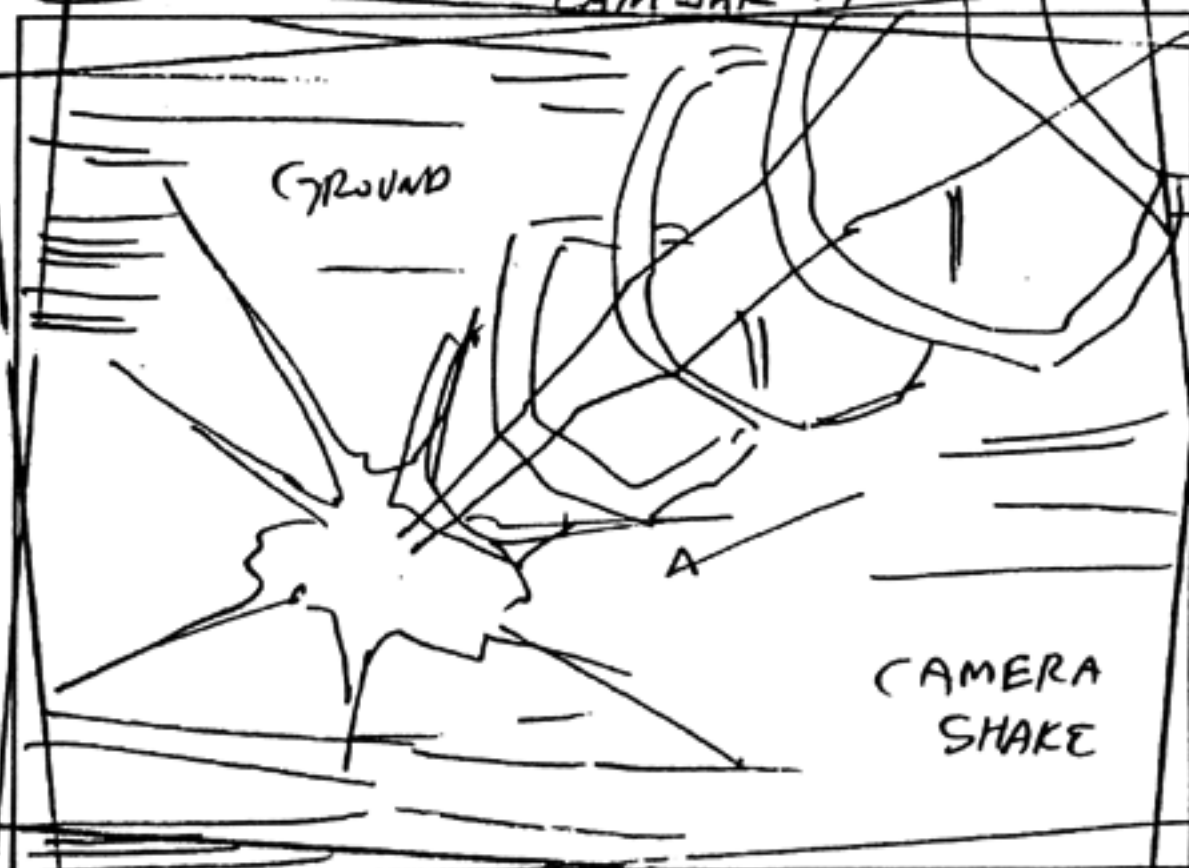

M. SHOT GROUND. UNDULATING ENERGY WAVE  
ENTERS AND EXPLODES AGAINST THE GROUND.

CONT CAMERA SHAKE

239

CAMERA SHAKE

240

CAMERA SHAKE

200-13

80

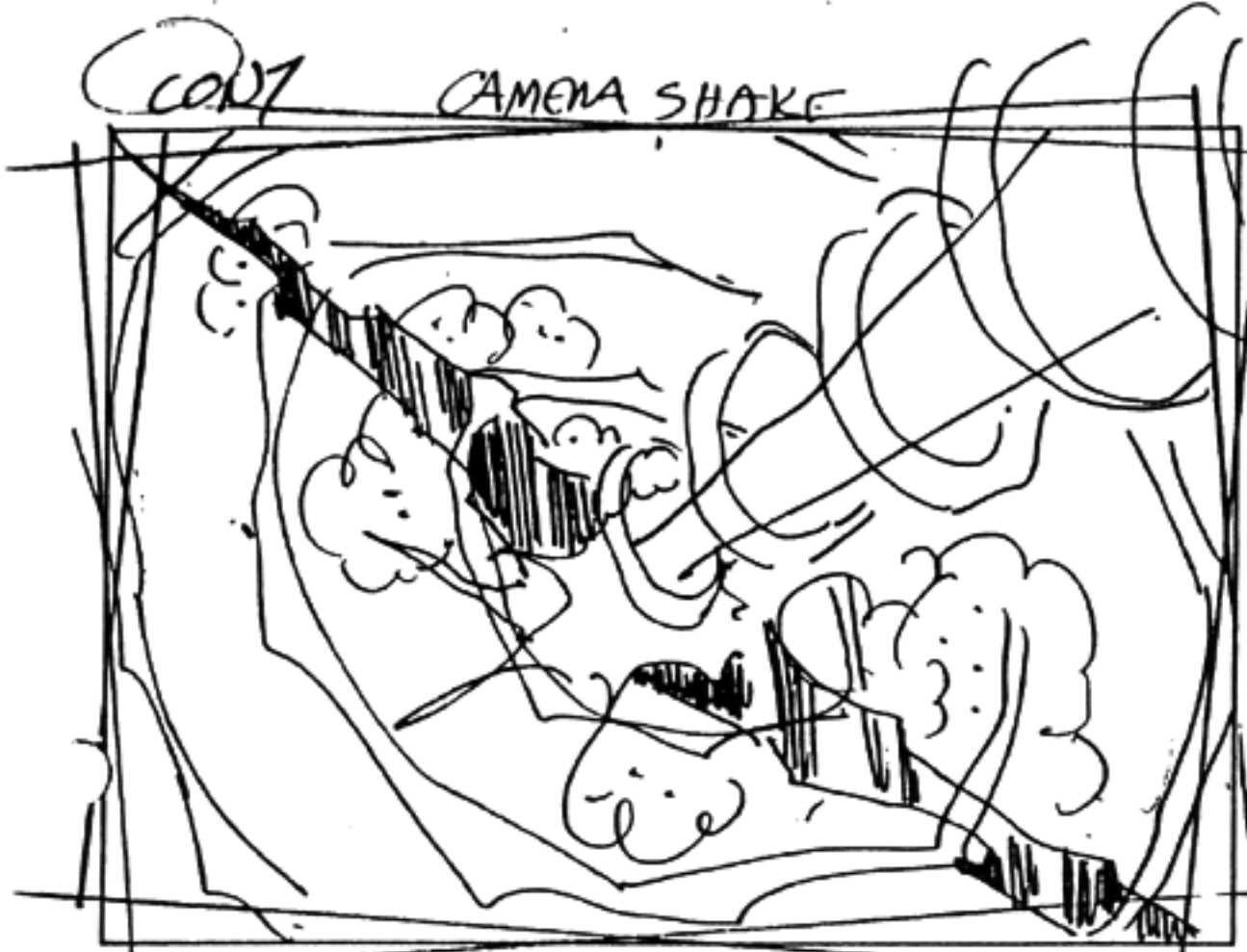

CAUSING A SPREADING DEEPENING FISSURE ALONG THE GROUND.

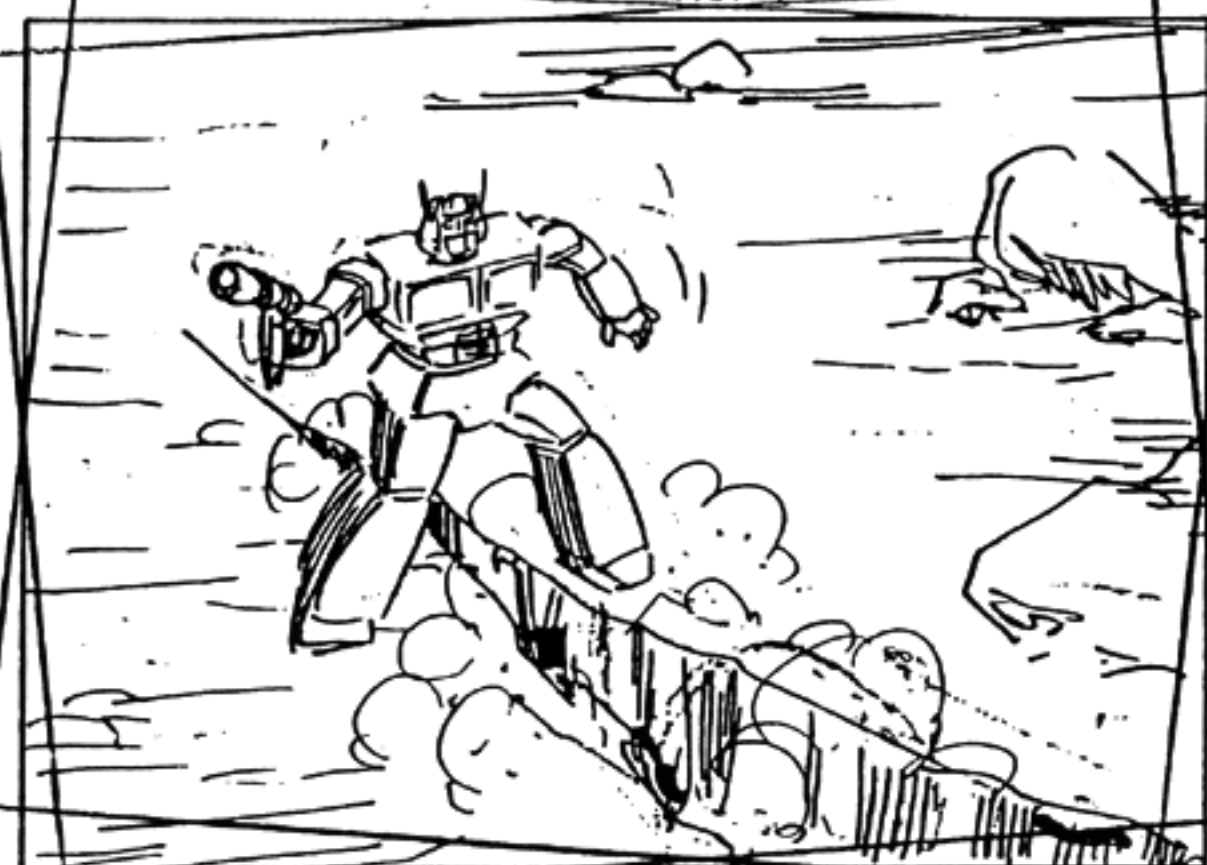

L.S. PRIME AS THE FISSURE SPREADS BENEATH HIS FEET

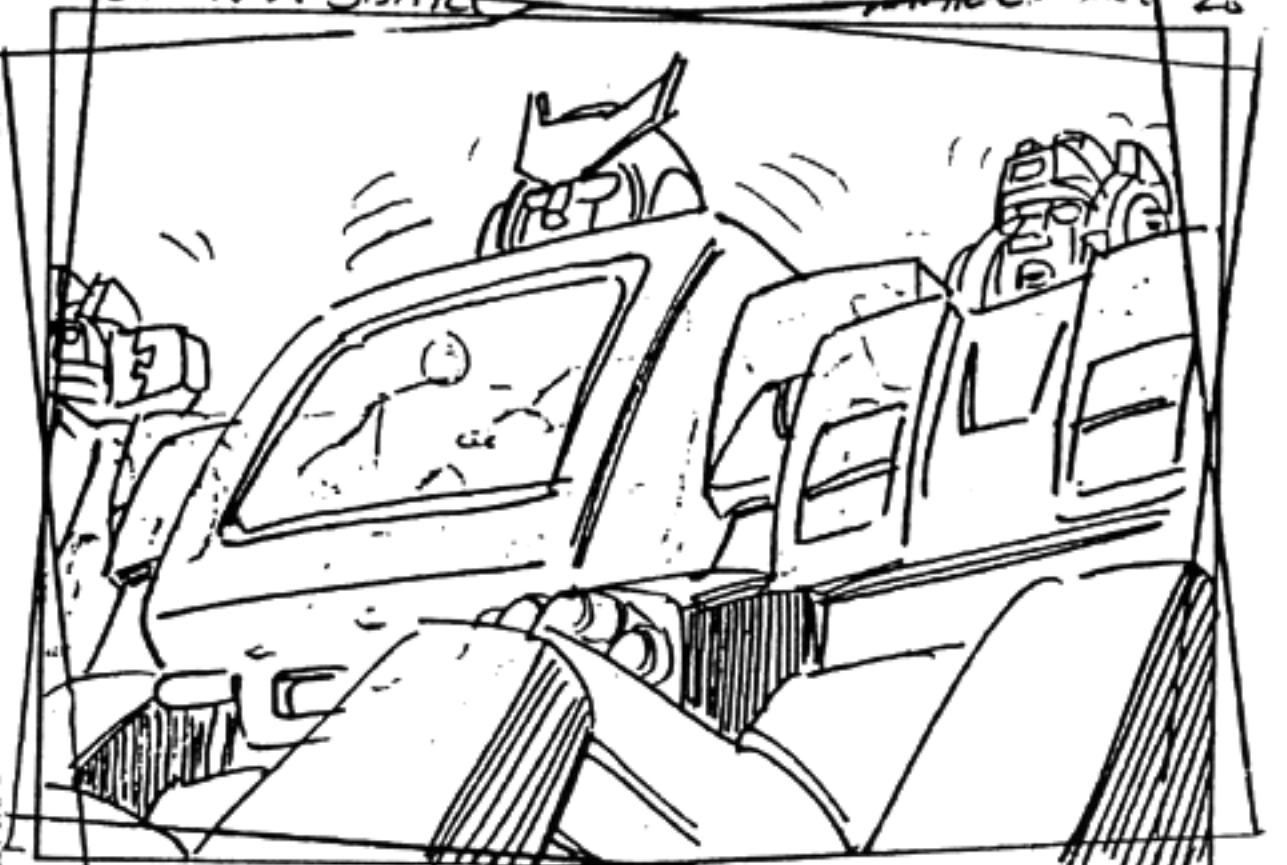

MIS, WHEELWELL, RATCHET, SUNSTRUCKEN SHAKEN BY THE QUAKE.

241

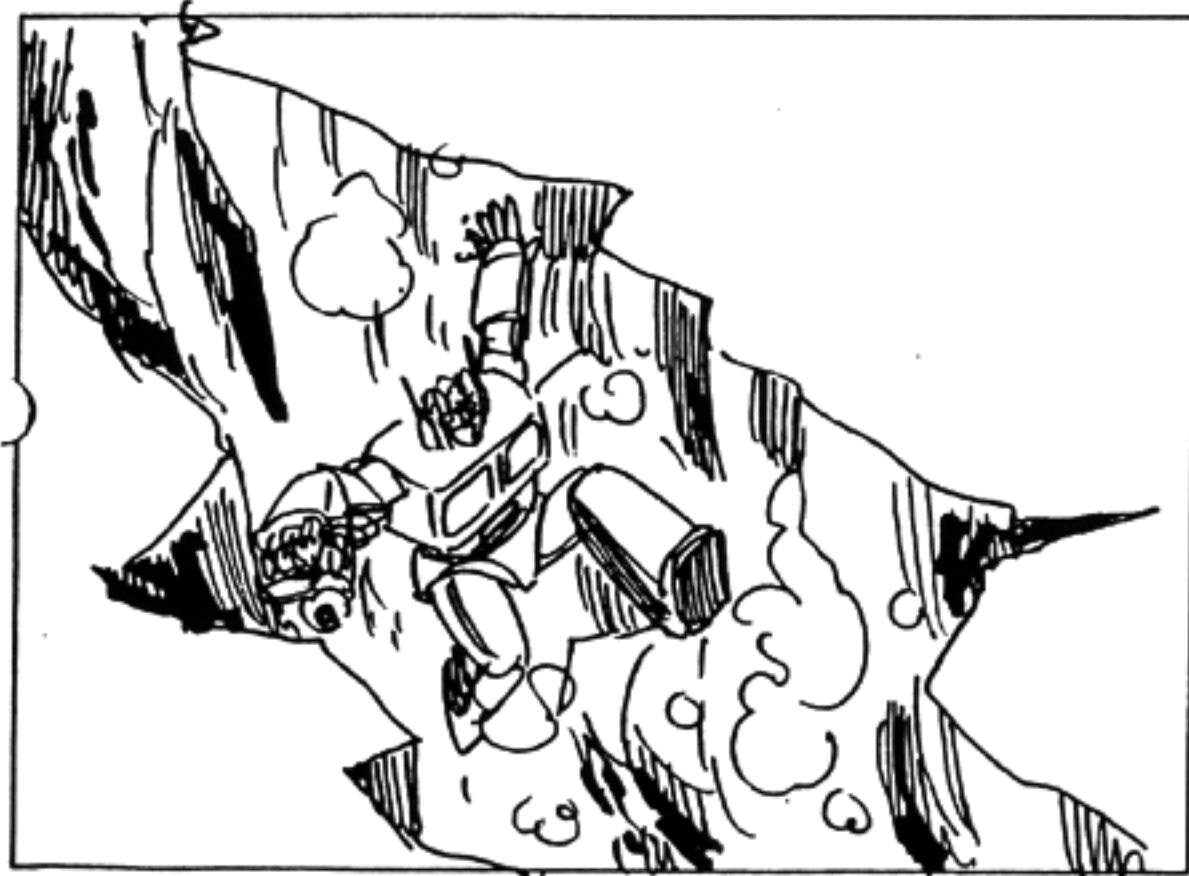

L.S. PRIME. HE FALLS INTO THE FISSURE ...

CONT...

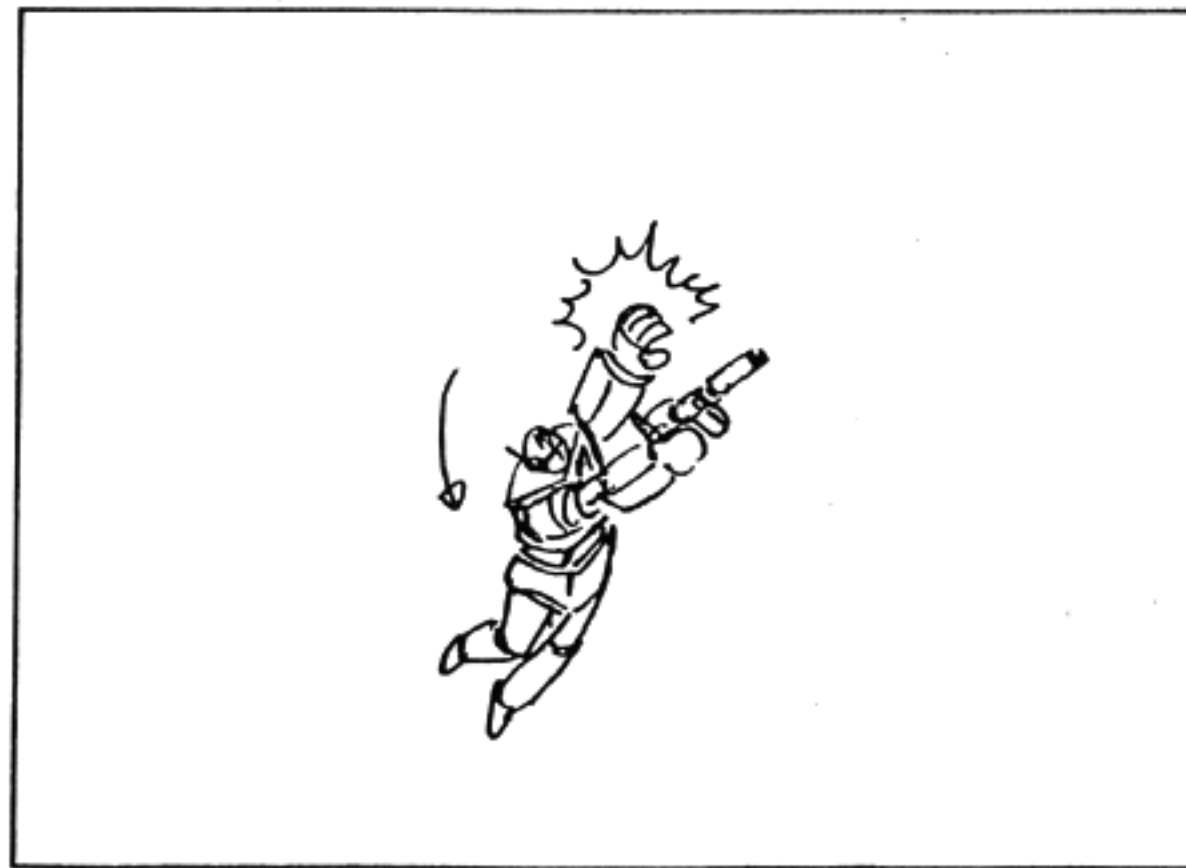

... BUT HE IS ABLE TO GET A HAND HOLD ON AN OUTCROPPING OF ROCK

242

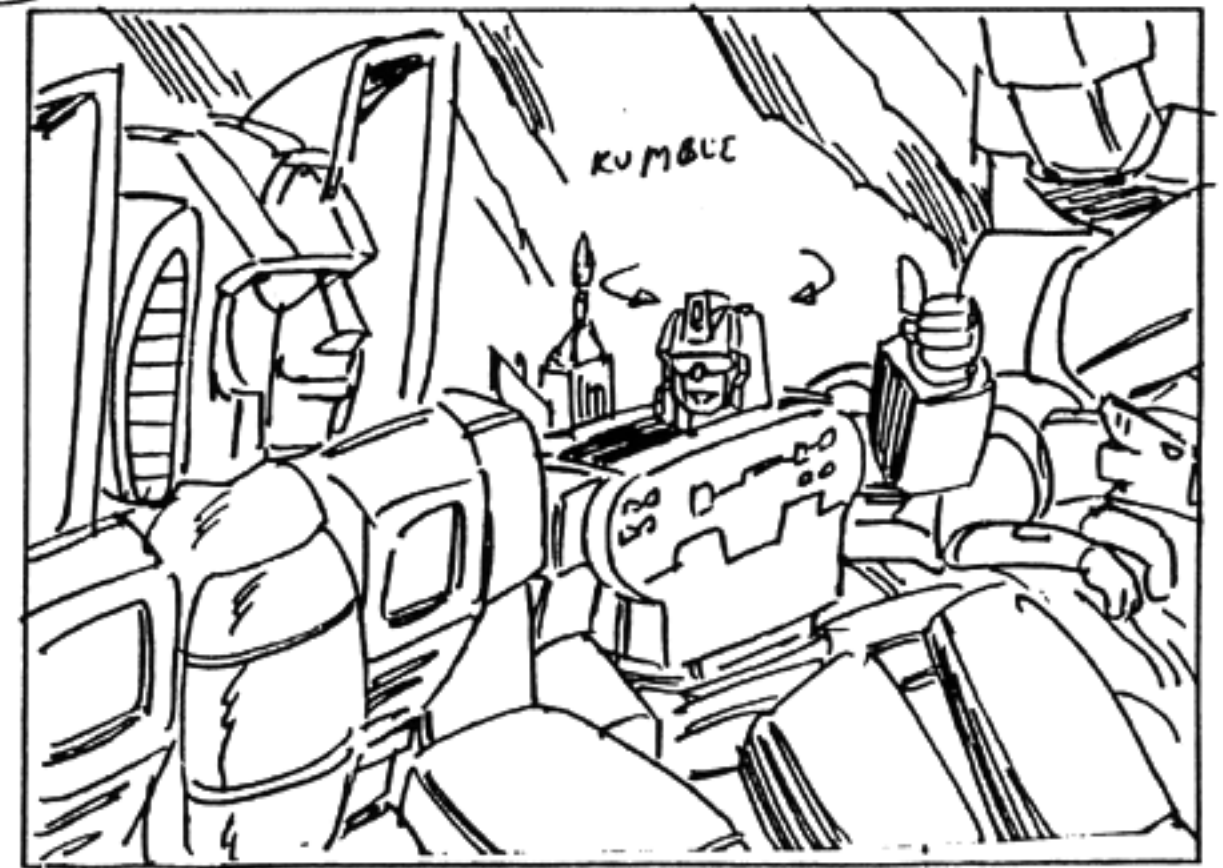

MIS, RUMBLE, THUNDERCRACKER, RAVAGE & SOUNDWAVE. RUMBLE GIVES A THUMBS UP SIGN TO HIS FRIENDS, INDICATING THAT WAS HIS BORROWED POWER IN USE.

243

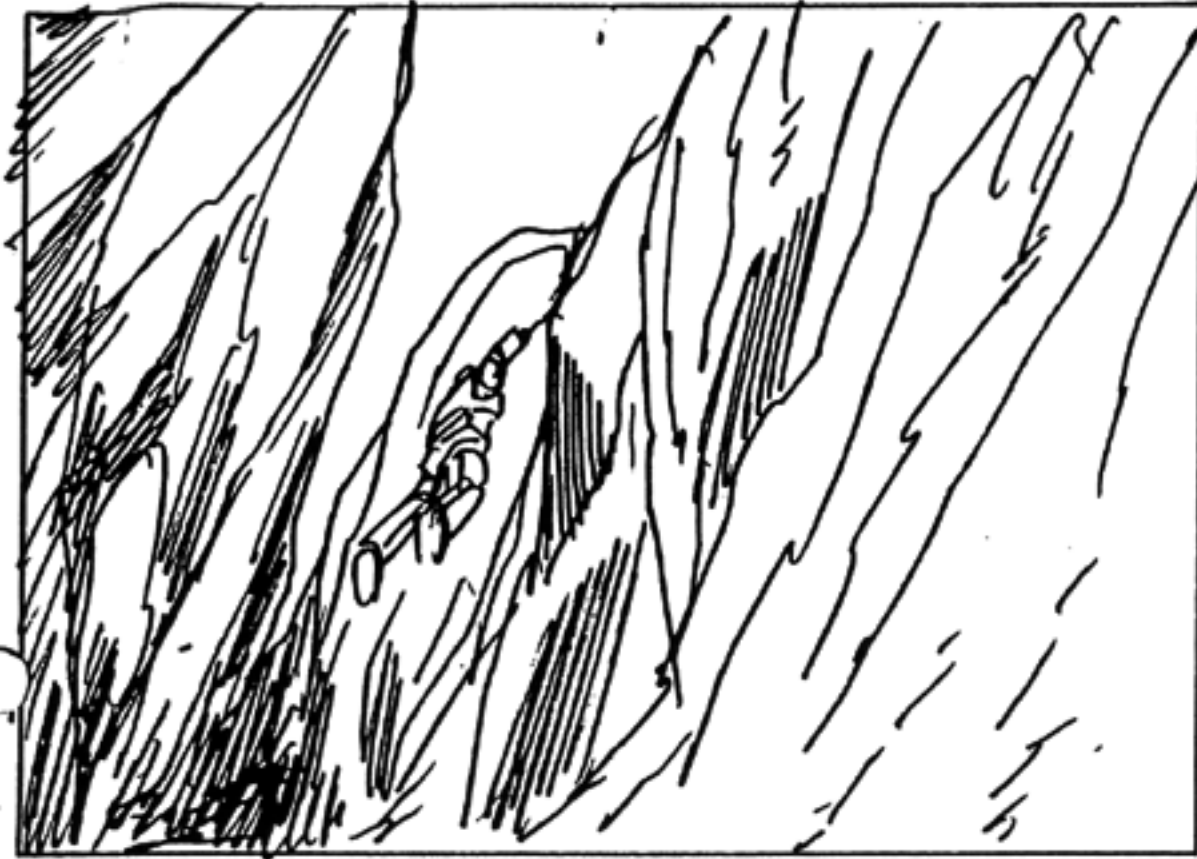

U.S. PRIME. HE CLIMBS OUT OF THE FISSURE.

CONT

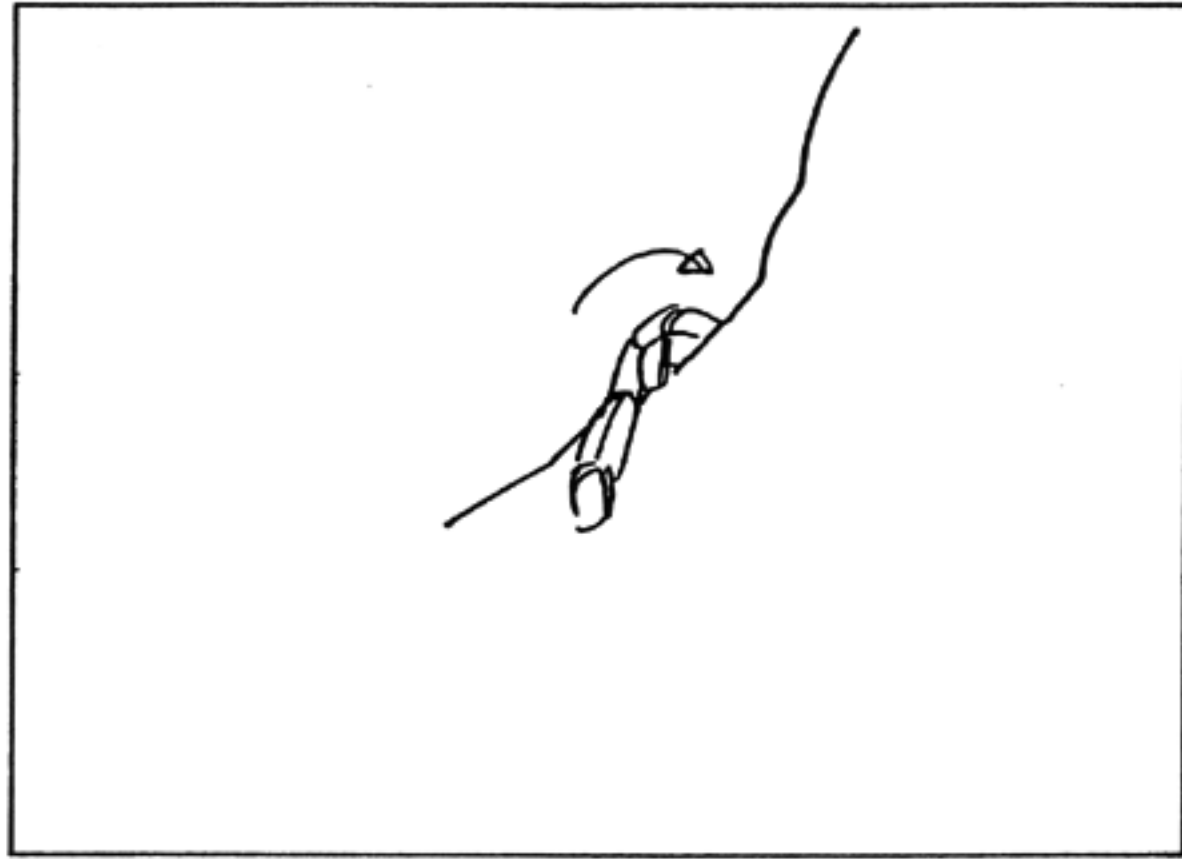

244

700-13

81



L.S. PRIME HE GRABS A LARGE BOULDER.

CONT

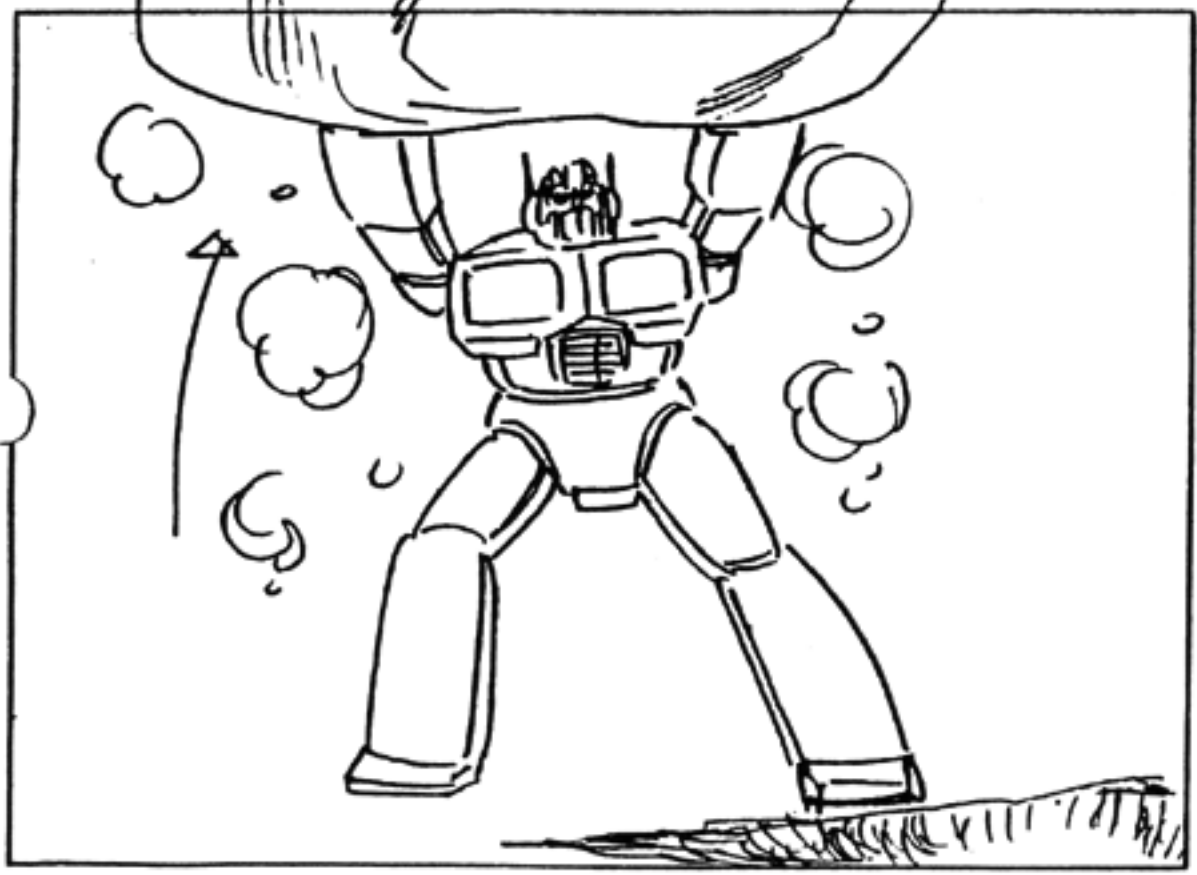

...LIFTS IT OVER HIS HEAD...

CONT.

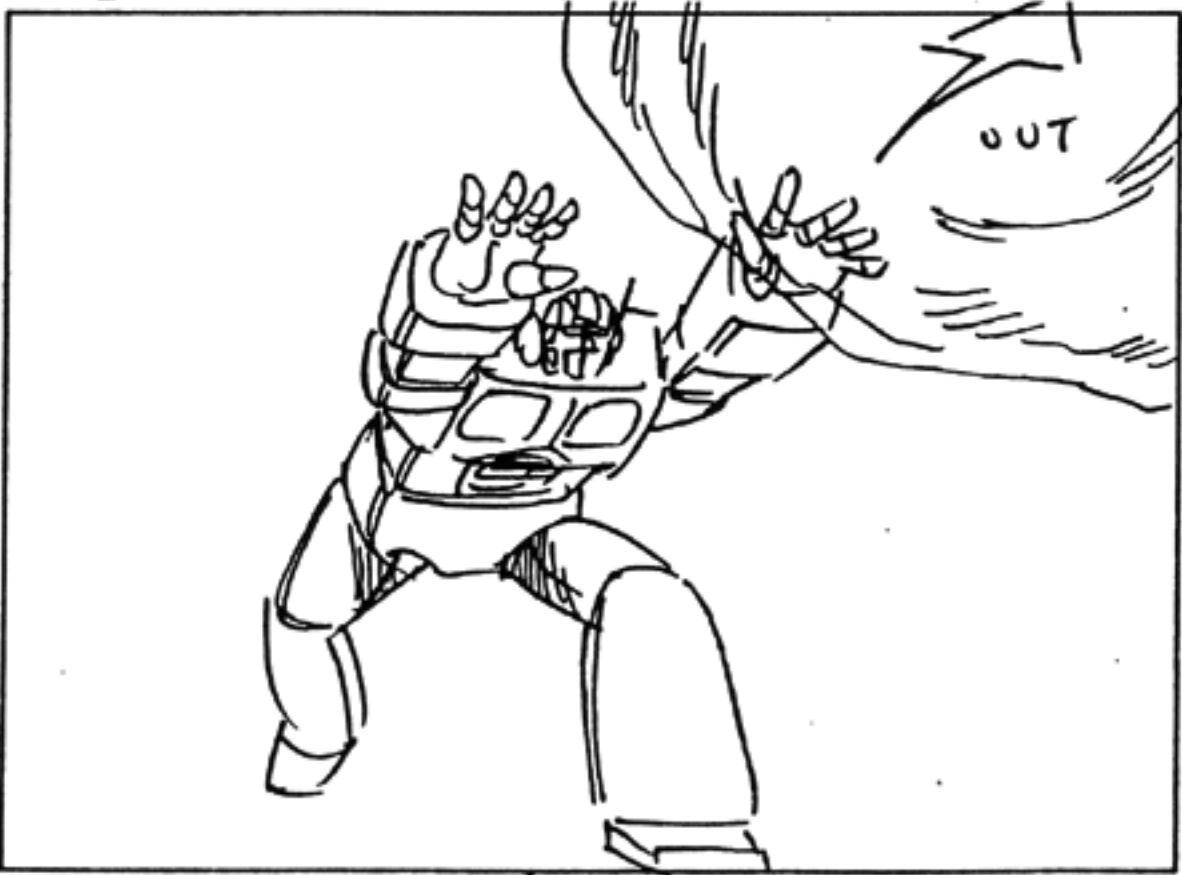

... AND THROWS IT AT MEGATRON!

245

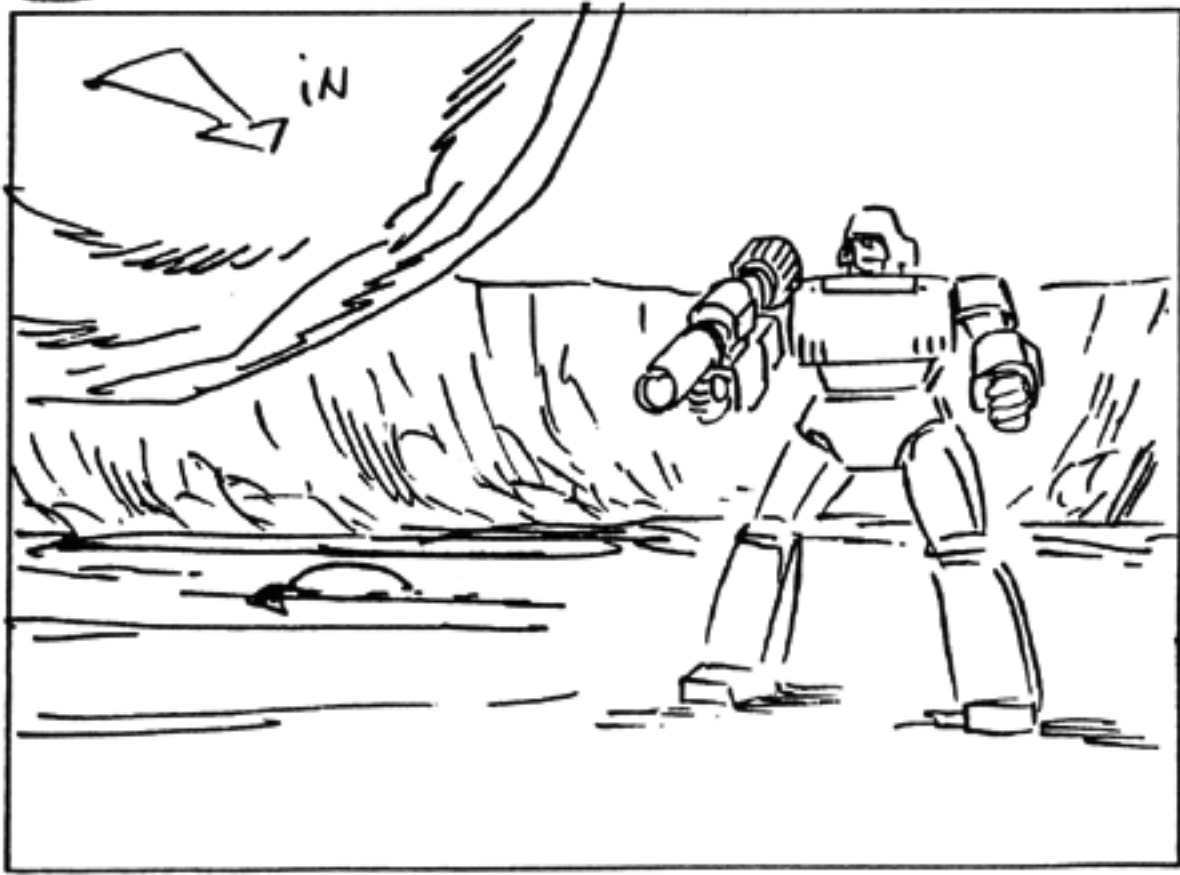

L.S. MEGATRON. THE BOULDER FLIES STRAIGHT FOR HIM.

CONT

\* SEE ON SC 58 IN DAY #3 (4025)  
FX

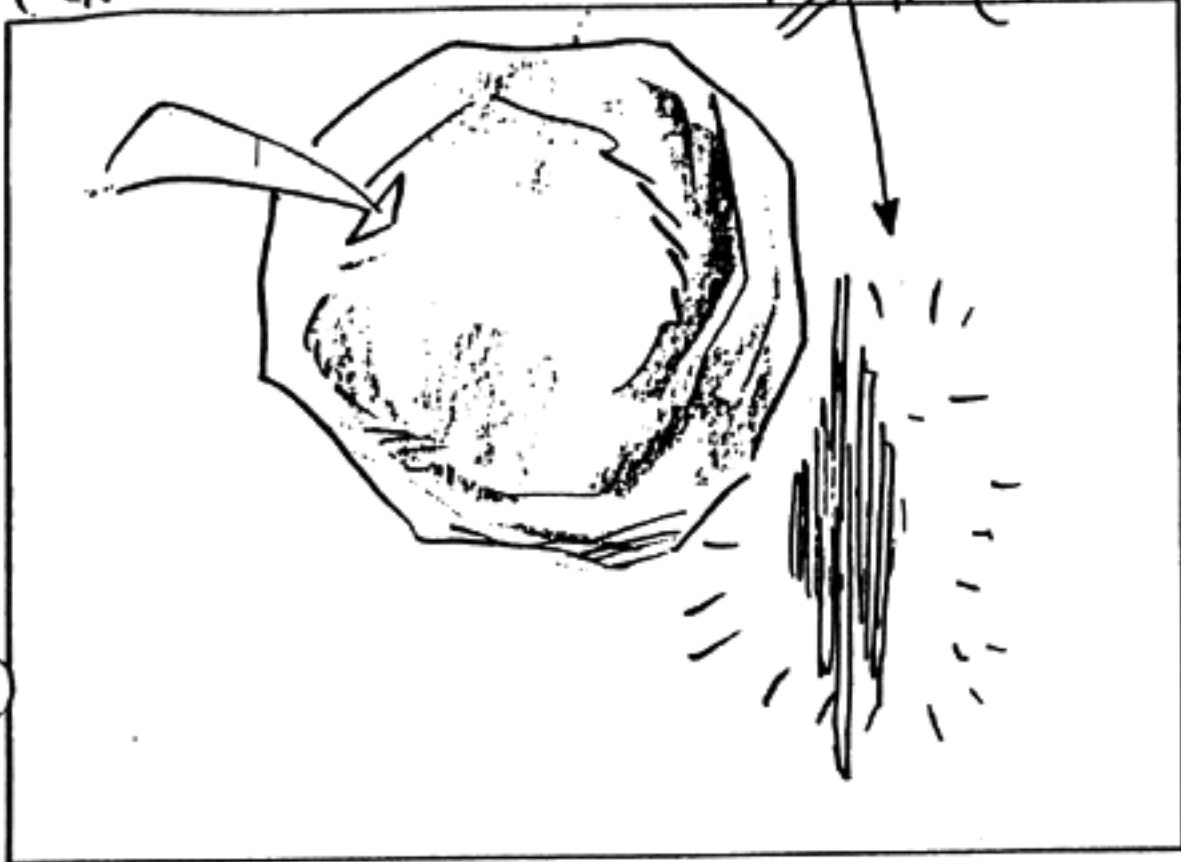

BUT BEFORE IT CAN HIT HIM  
MEGATRON VANISHES

CONT

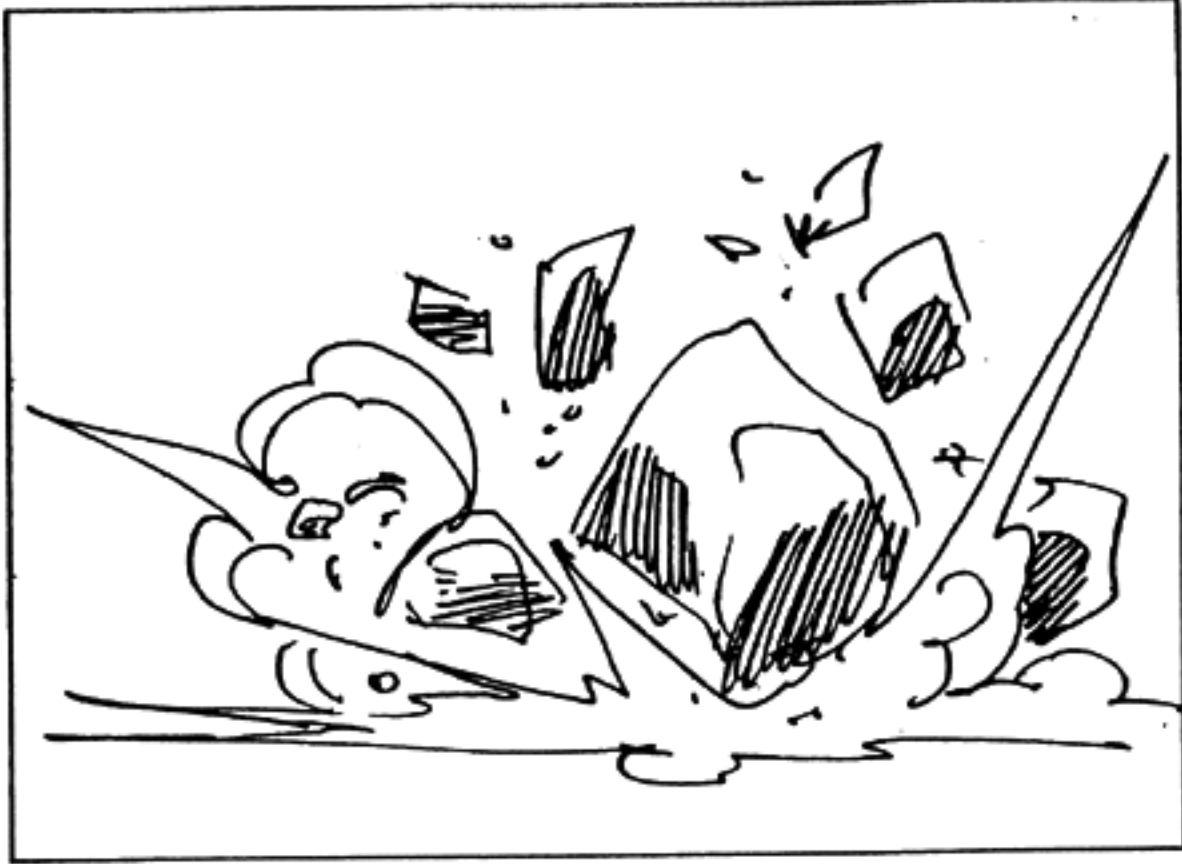

AS THE BOULDER SMASHES...

CONT. 700-13

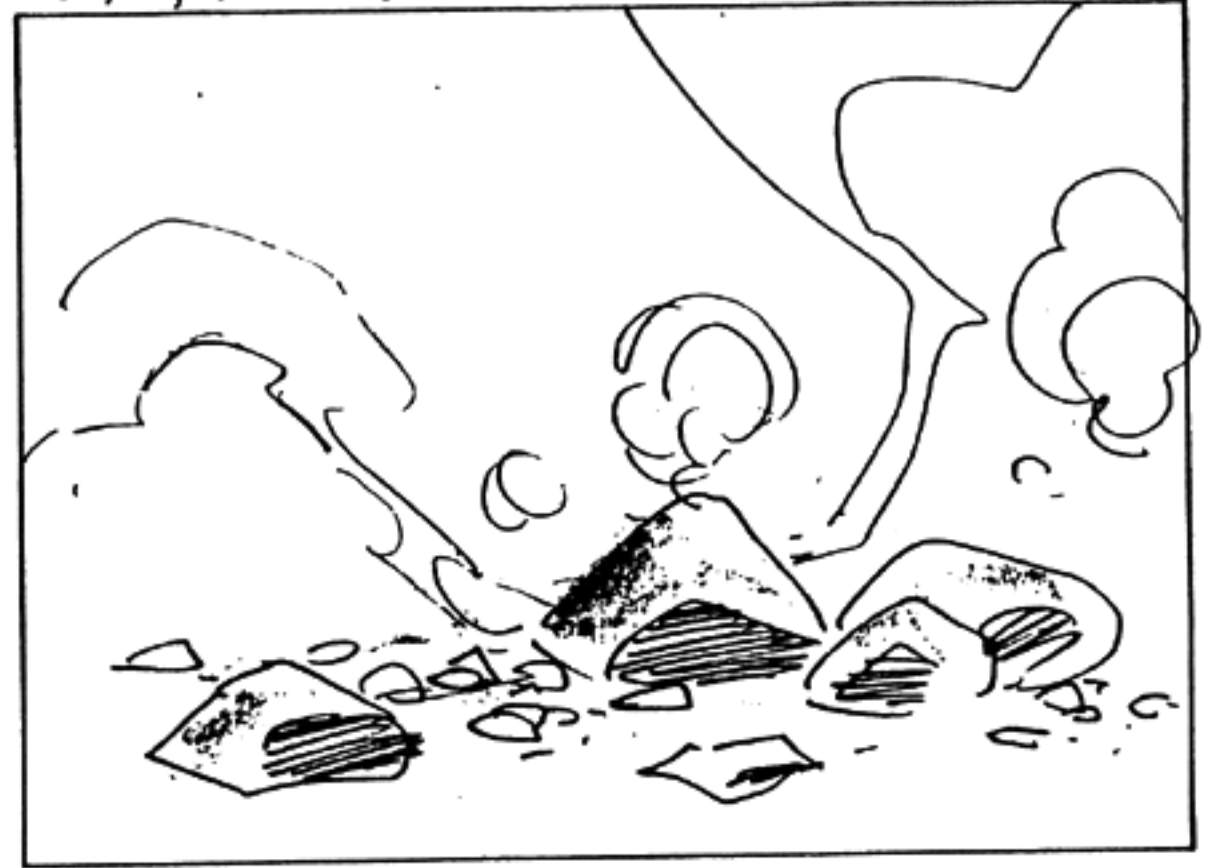

TO THE GROUND WHERE HE ONCE STOOD.

246

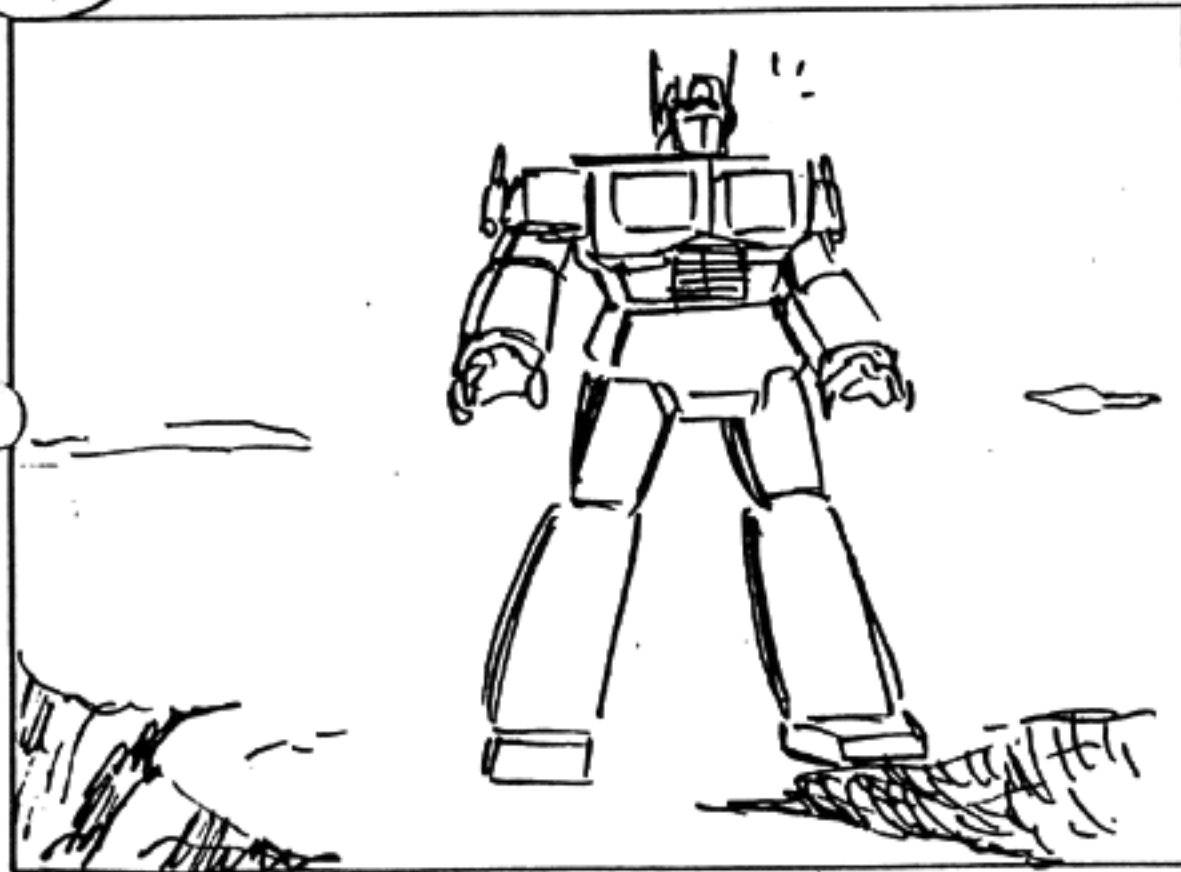

M. SHOT PRIME REACTS IN DISBELIEF TO  
THE O.S. VANISHING ACT.

CONT

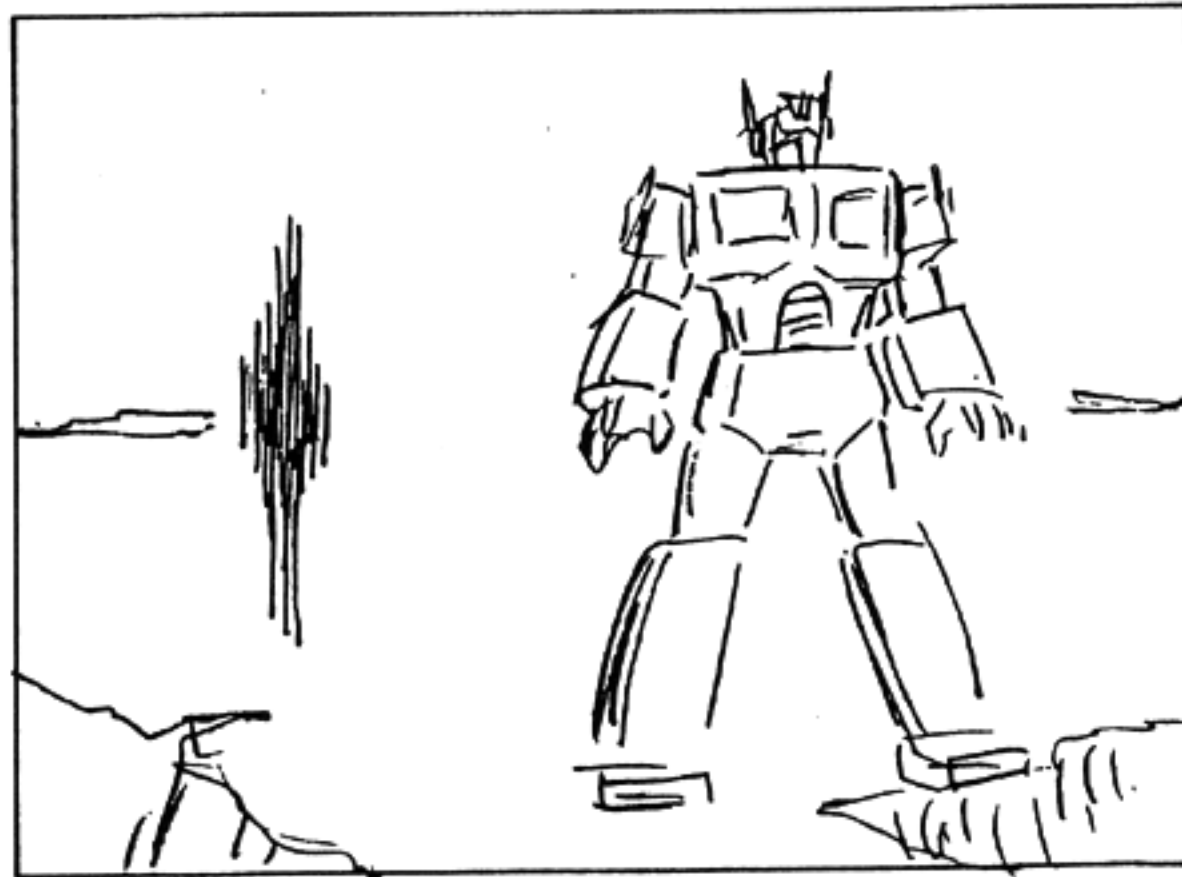

BEHIND HIM MEGATRON MATERIALIZES AND STARTS TO RAISE HIS FUSION CANNON.

CONT

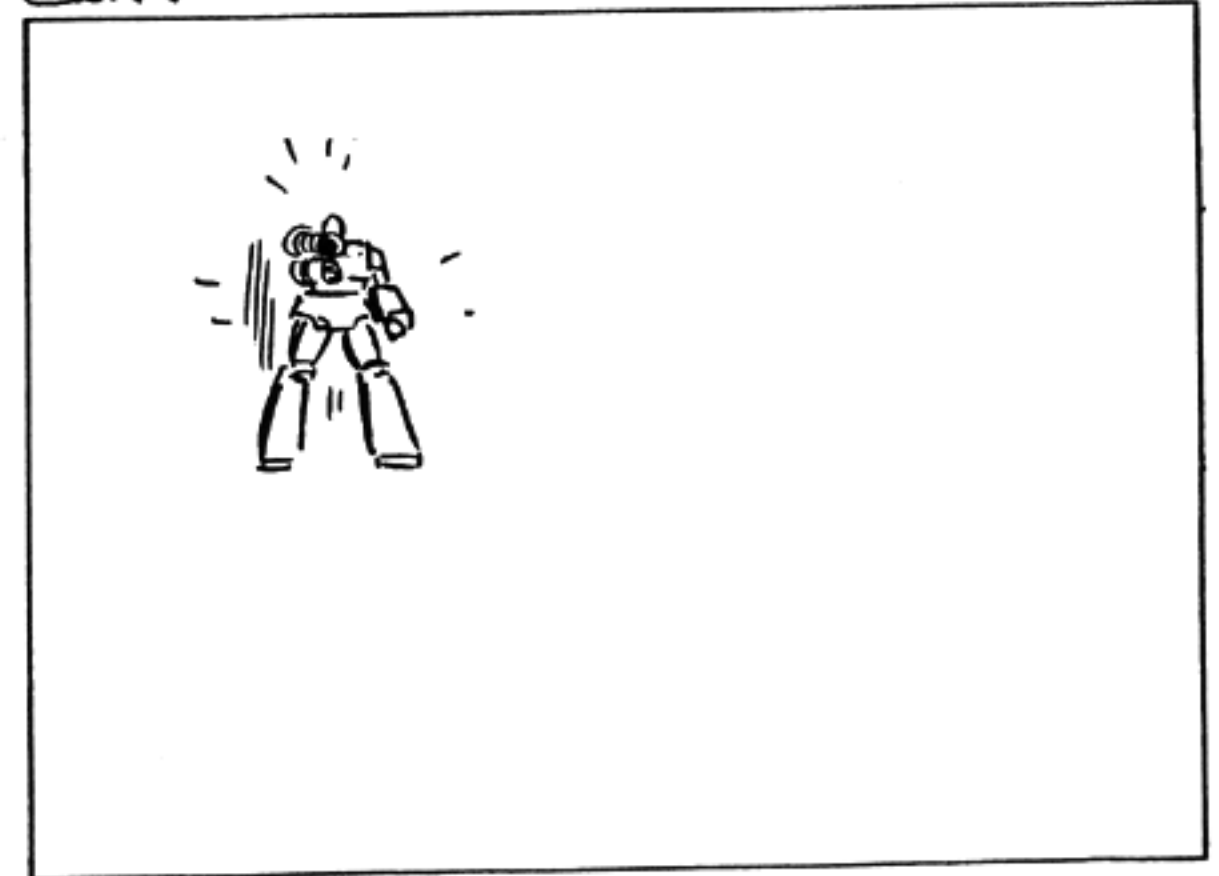

247



M.S. SKYWARP & STARSCREAM  
SKYWARP: YOU SHOULD SEE ME DO THAT WHEN I'VE GOT MY POWER CLIPS.

248

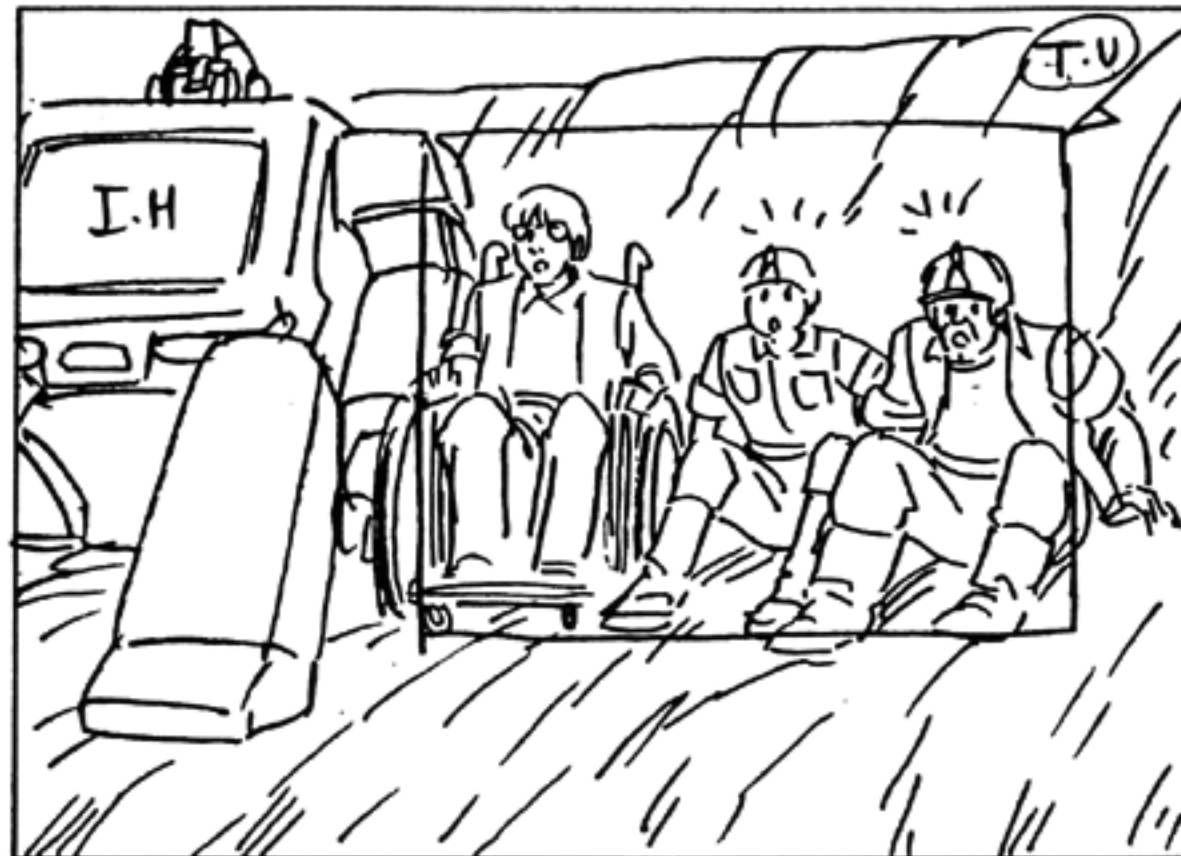

M.S. IRONHIDE, SPIKE, CHIP, SPARKPLUG  
REACT IN SHOCK!

SPIKE: OPTIMUS, BEHIND YOU!

249

200-13

83

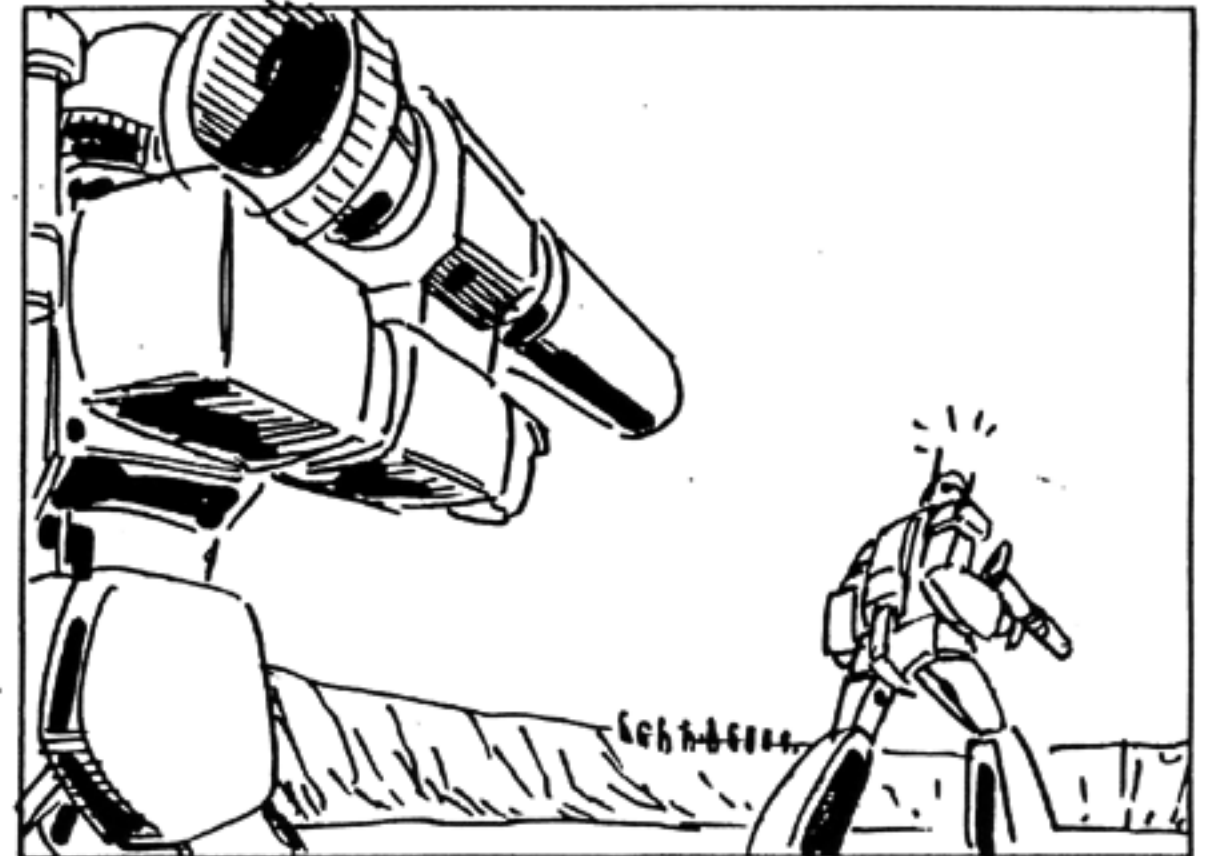

LIS PRIME TURNS AT THE WARNING

250

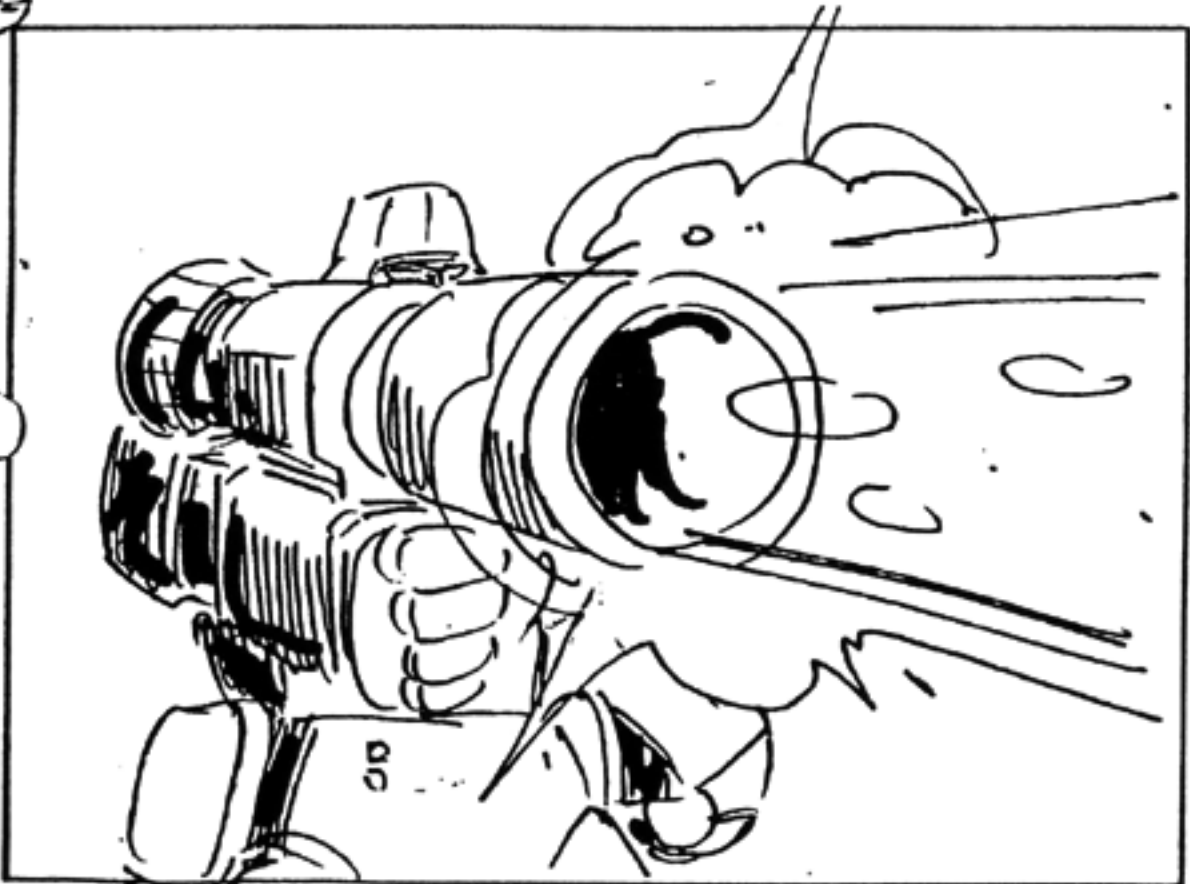

M.S. MEGATRON HE TAKES AIM AND FIRES. SOUNDWAVES CONCUSSION BLAST.

251

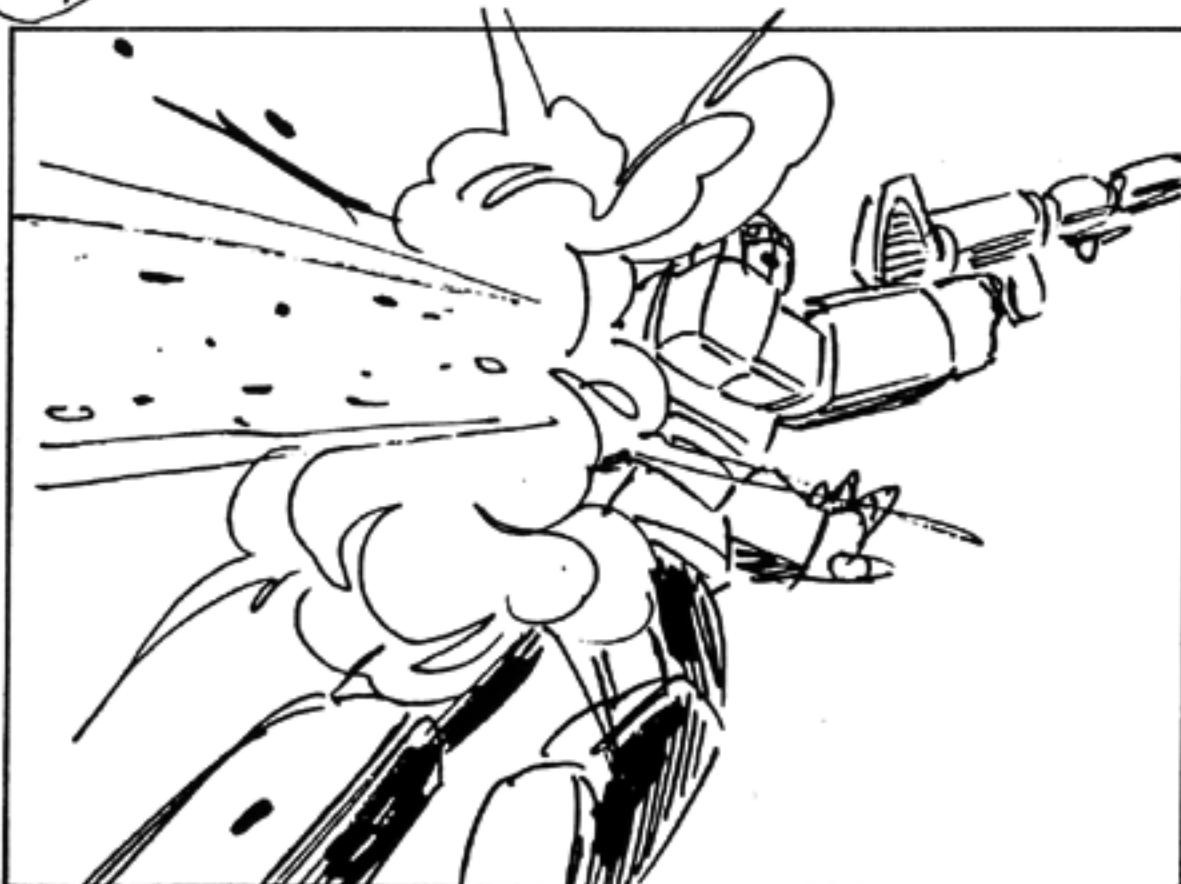

MIS. PRIME: THE BLAST HITS HIM SQUARE IN THE BACK...

CONT.

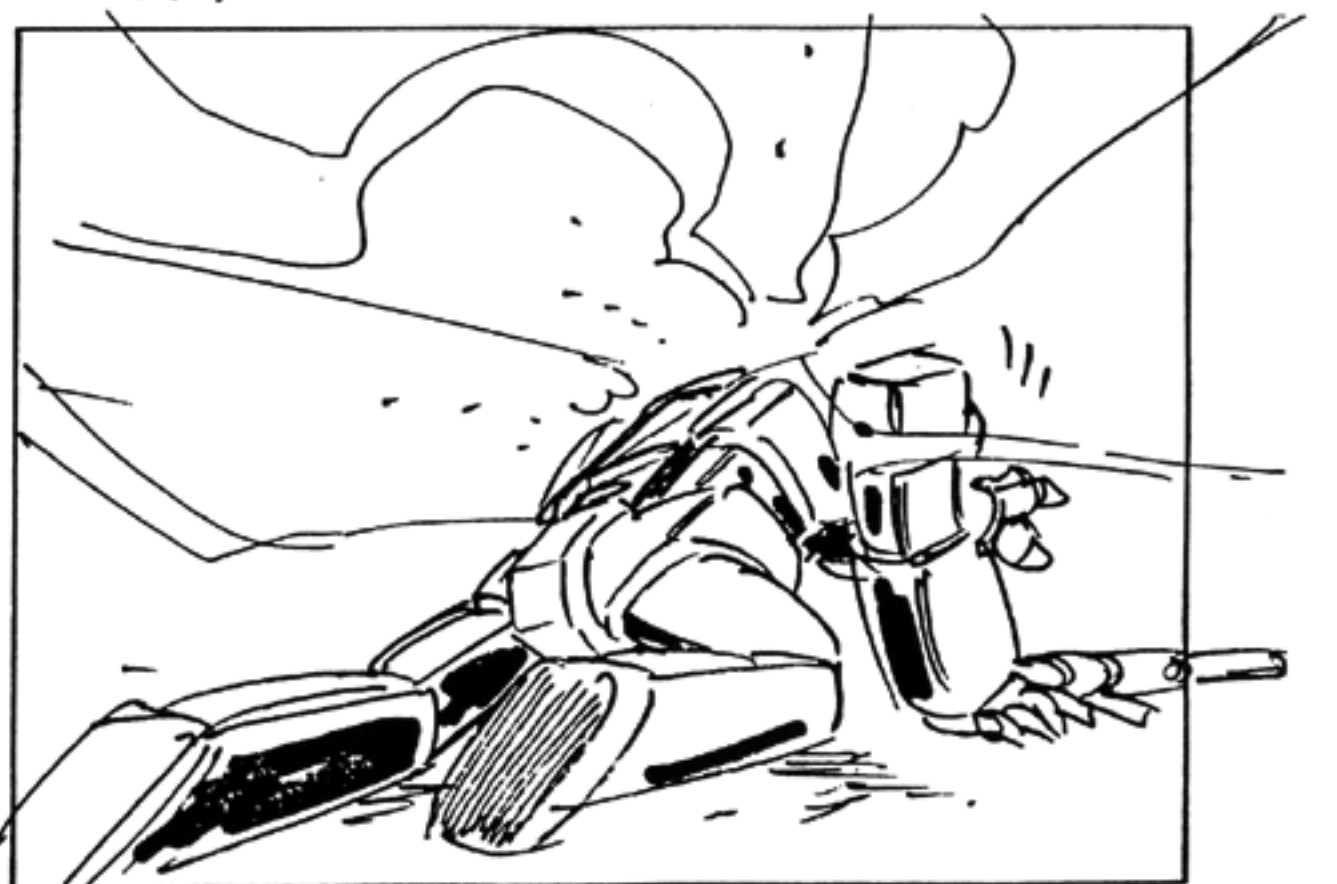

... KNOCKING HIM TO HIS KNEES SEMI-CONCIOUS.

252

84

STUNT PAN →

→ STOP 700-13

30-  
TRANSITION  
#2

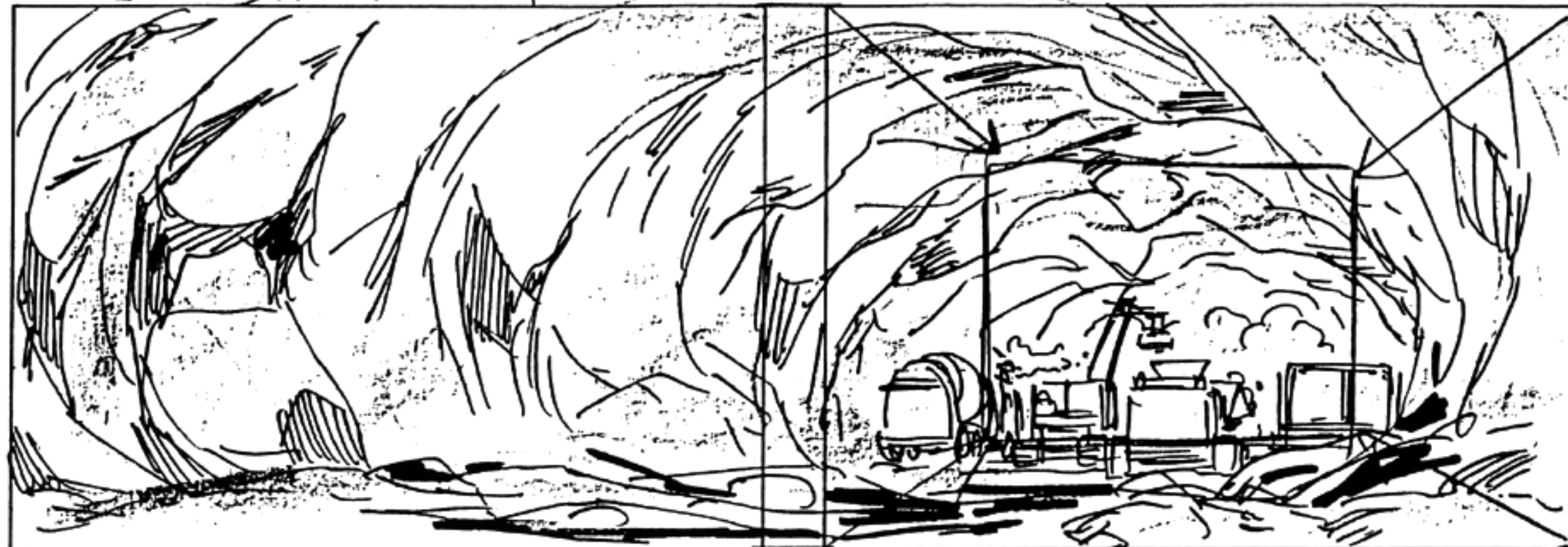

L.S. THE SIX CONSTRUCTION MACHINES STILL DIG THROUGH THE ROCK AS IN THE EARLIER SCENES. BONECRUSHER AND BULLDOZER REPEATEDLY RAM AGAINST THE WALL WEAKENING IT.

253

TRUCK-OUT

CONT

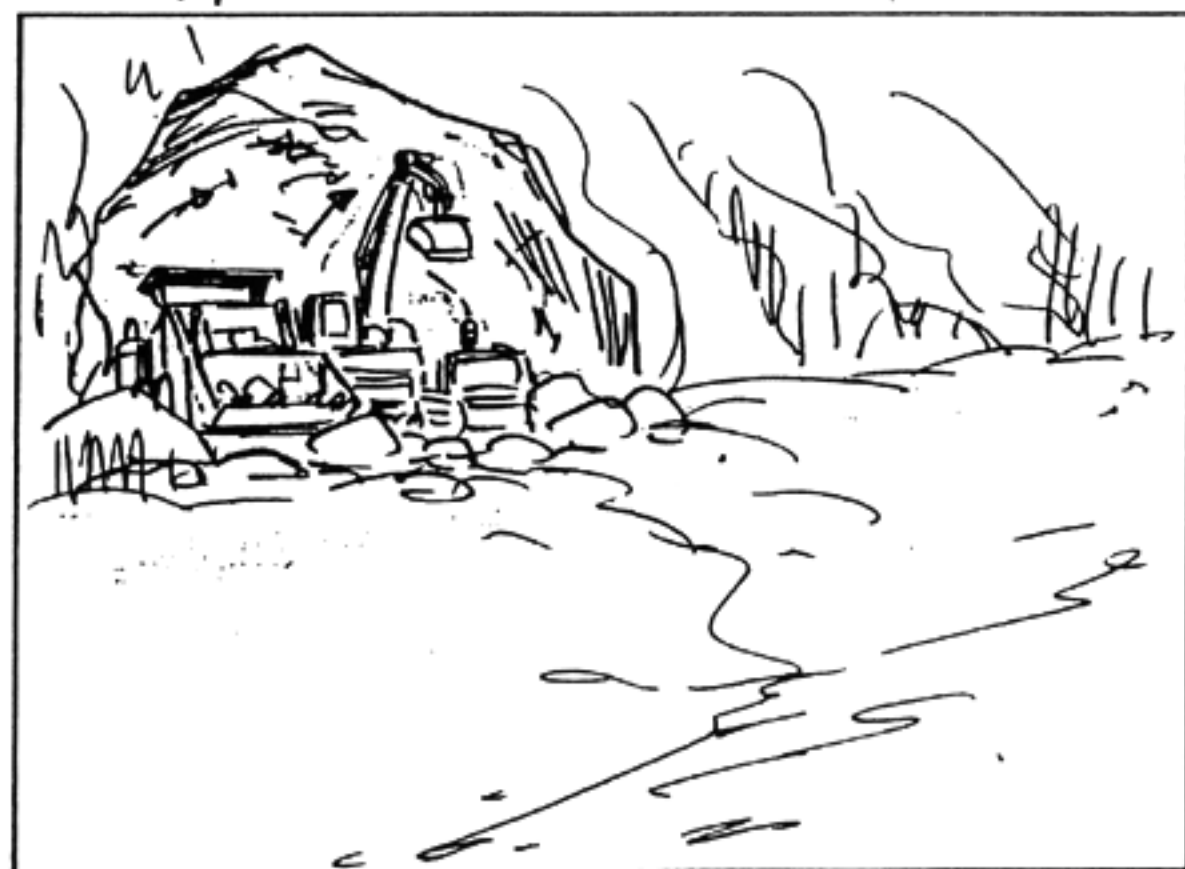
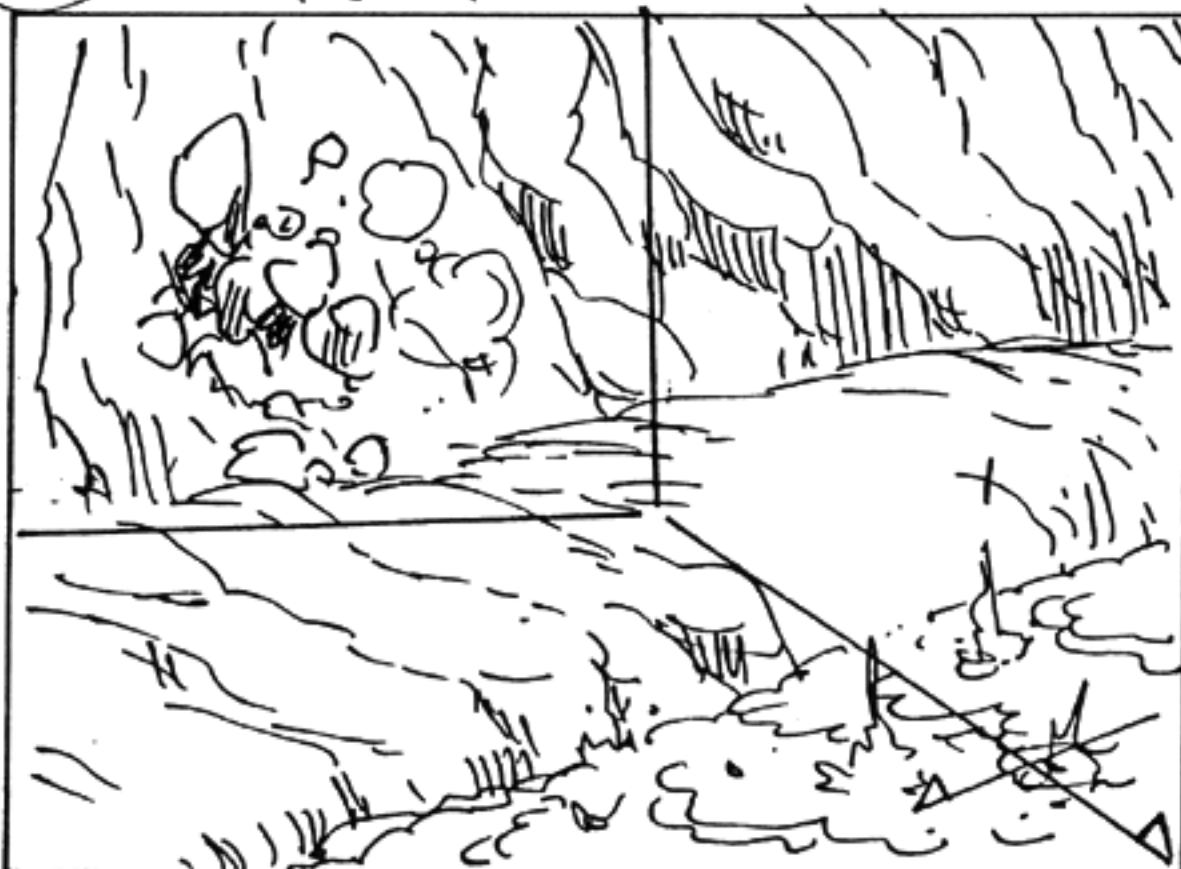
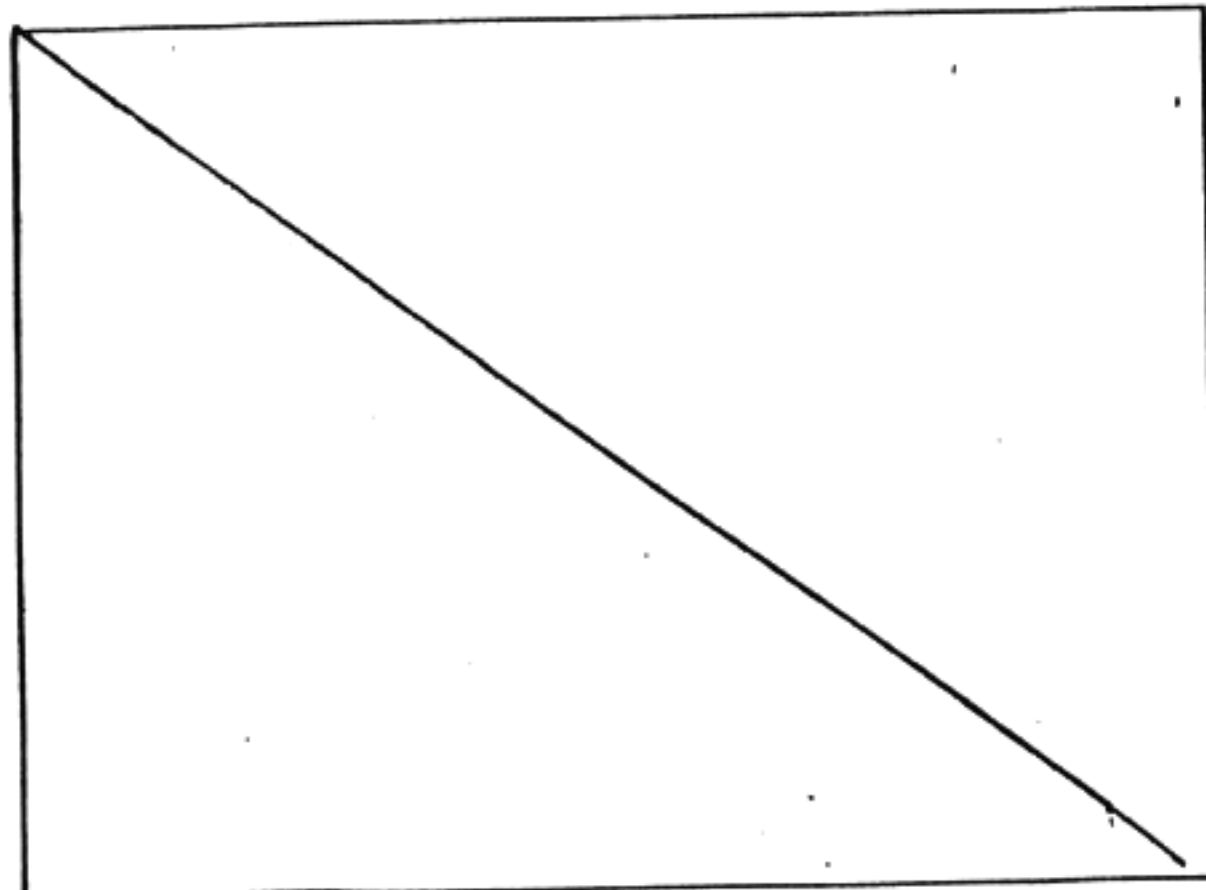

L.S. INSIDE CAVERN. LAVA RIVER BURNING AND BOILING. CRACKS FORM IN THE WALL FROM THE O.S. RAMMING

SUDDENLY THE ROCK WALL GIVES WAY AND BONECRUSHER FOLLOWED BY THE OTHER CONSTRUCTION MACHINES RUMBLE THROUGH THE STONY RUBBLE.

254

CONT

CONT

700-13

85



DIS. THE CONSTRUCTION AND A LAVA RIVER. SCAVANGER SCOOPS UP...

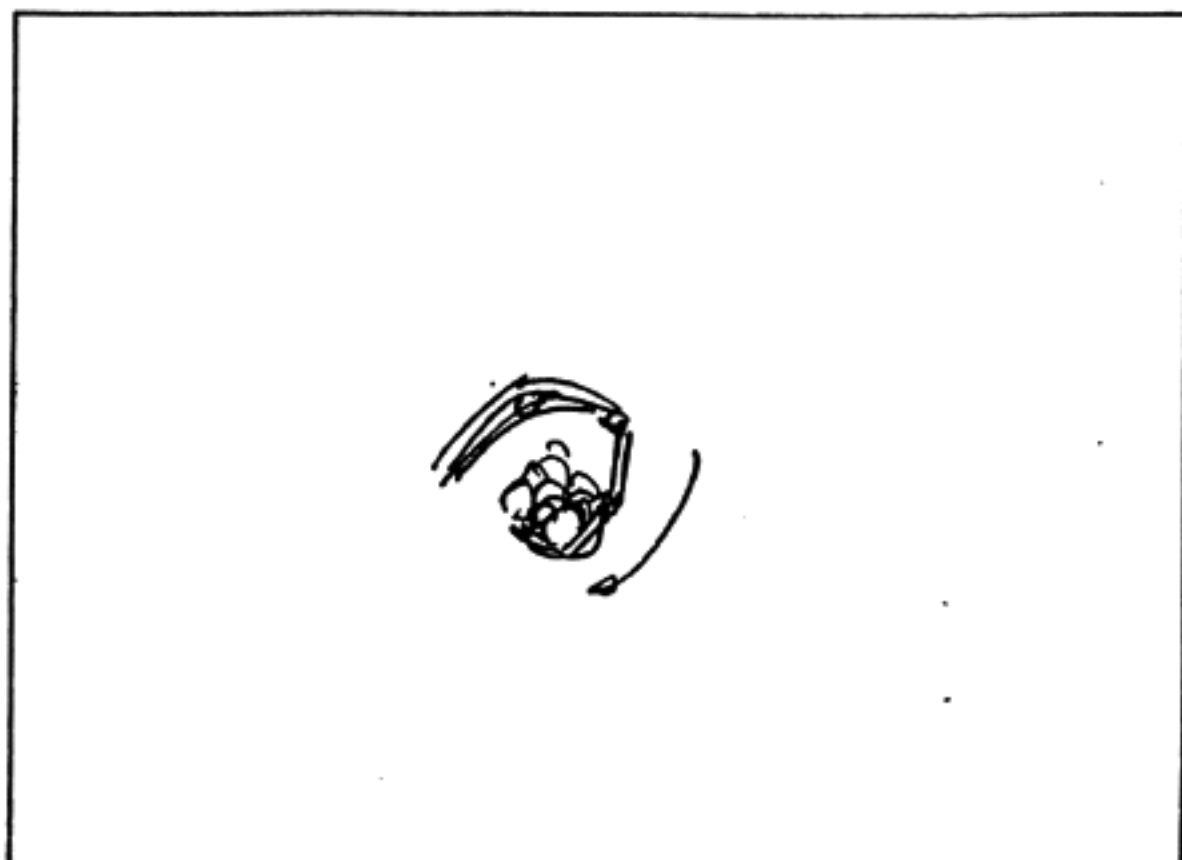

... SOME BIG ROCKS AND...

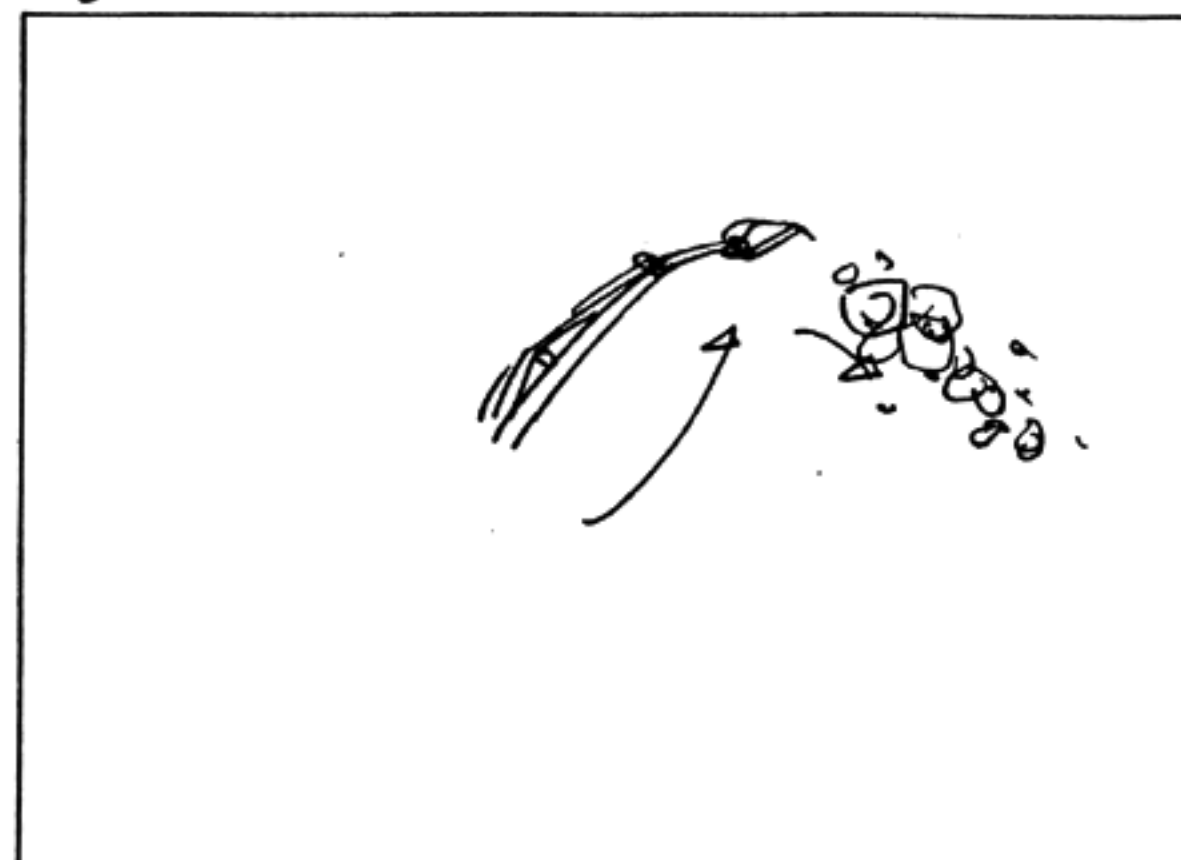

... THROWS THEM ...

CONT

CONT

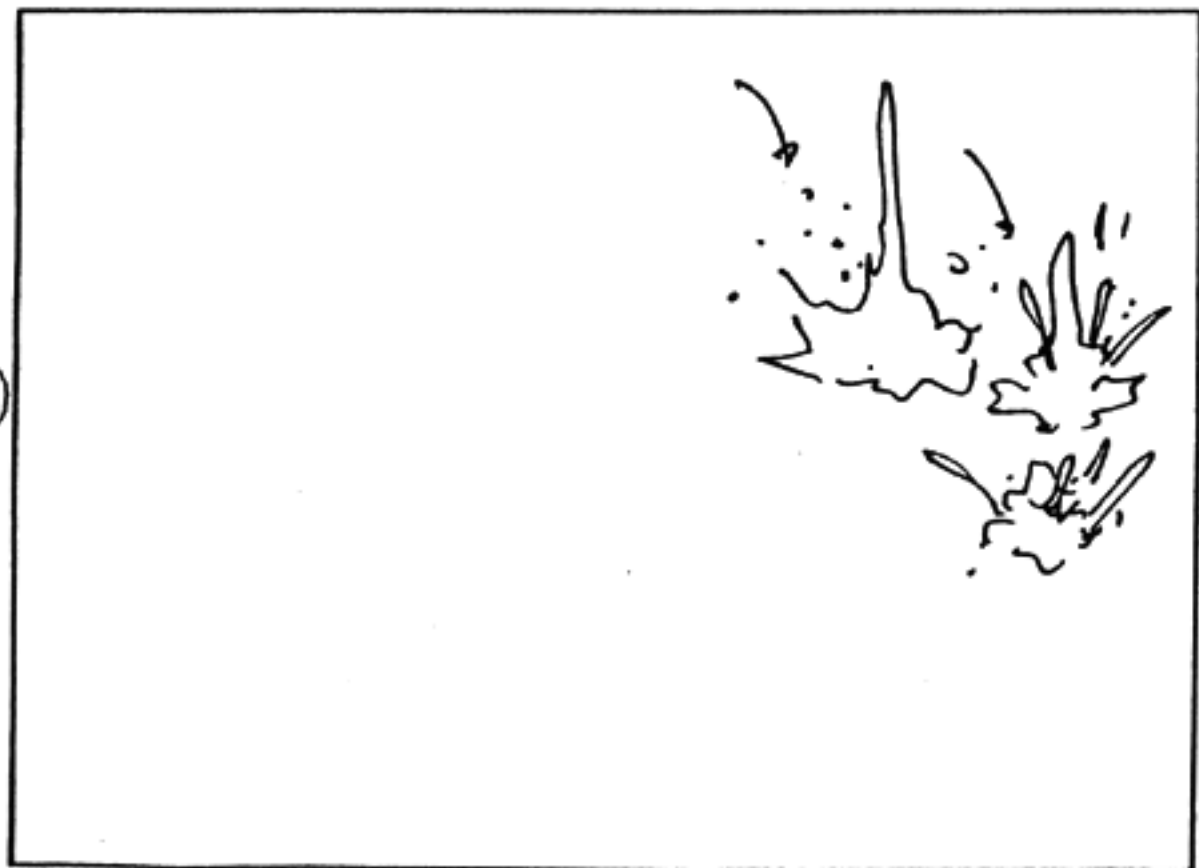

... INTO THE LAVA RIVER...



... WHERE THEY CAUSE EXPLOSIONS OF HEAT AND RISING SMOKE.

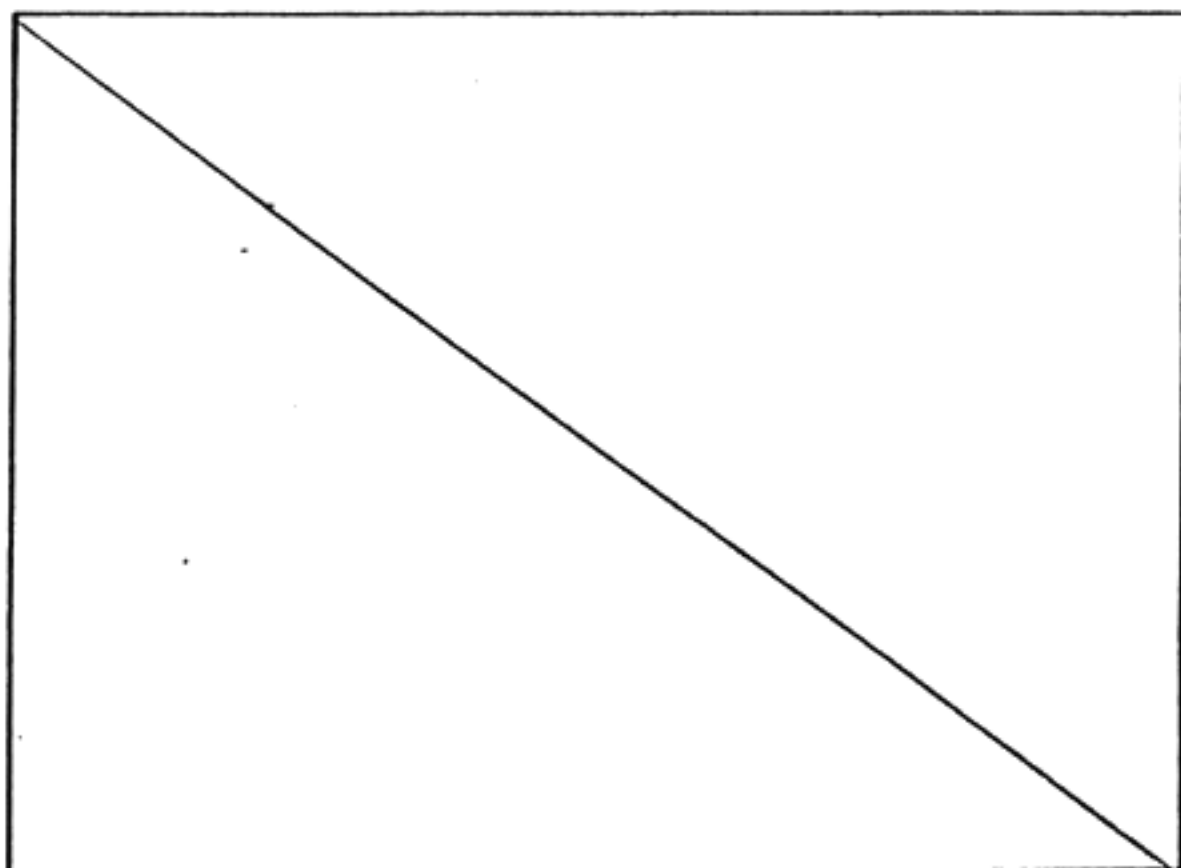

255

700-13

86

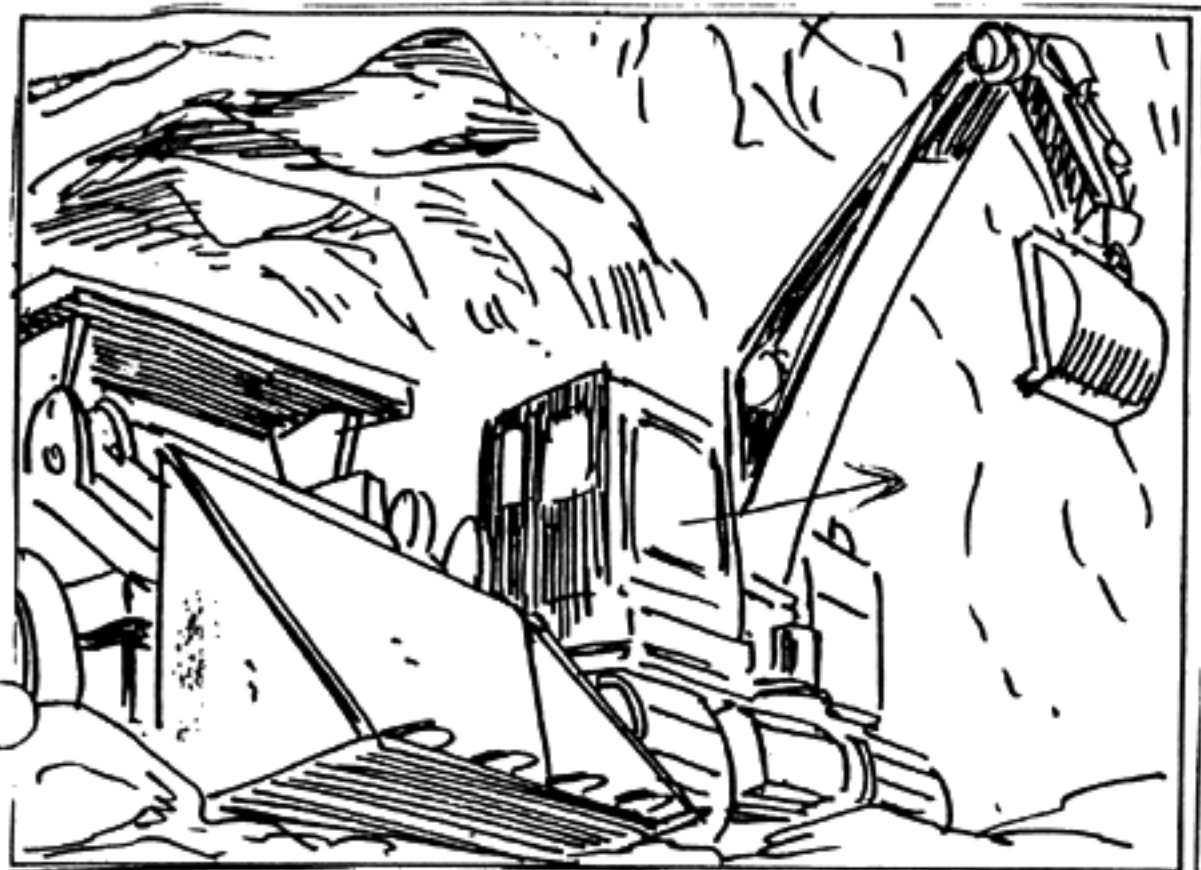

MS. SCRAPPER F SCAVANGER  
 SCRAPPER PUSHES SCAVANGER TO THE  
 SIDE SCRAPPER: CAREFUL, SCAVANGER!  
 THIS VOLCANO ISN'T INACTIVE.

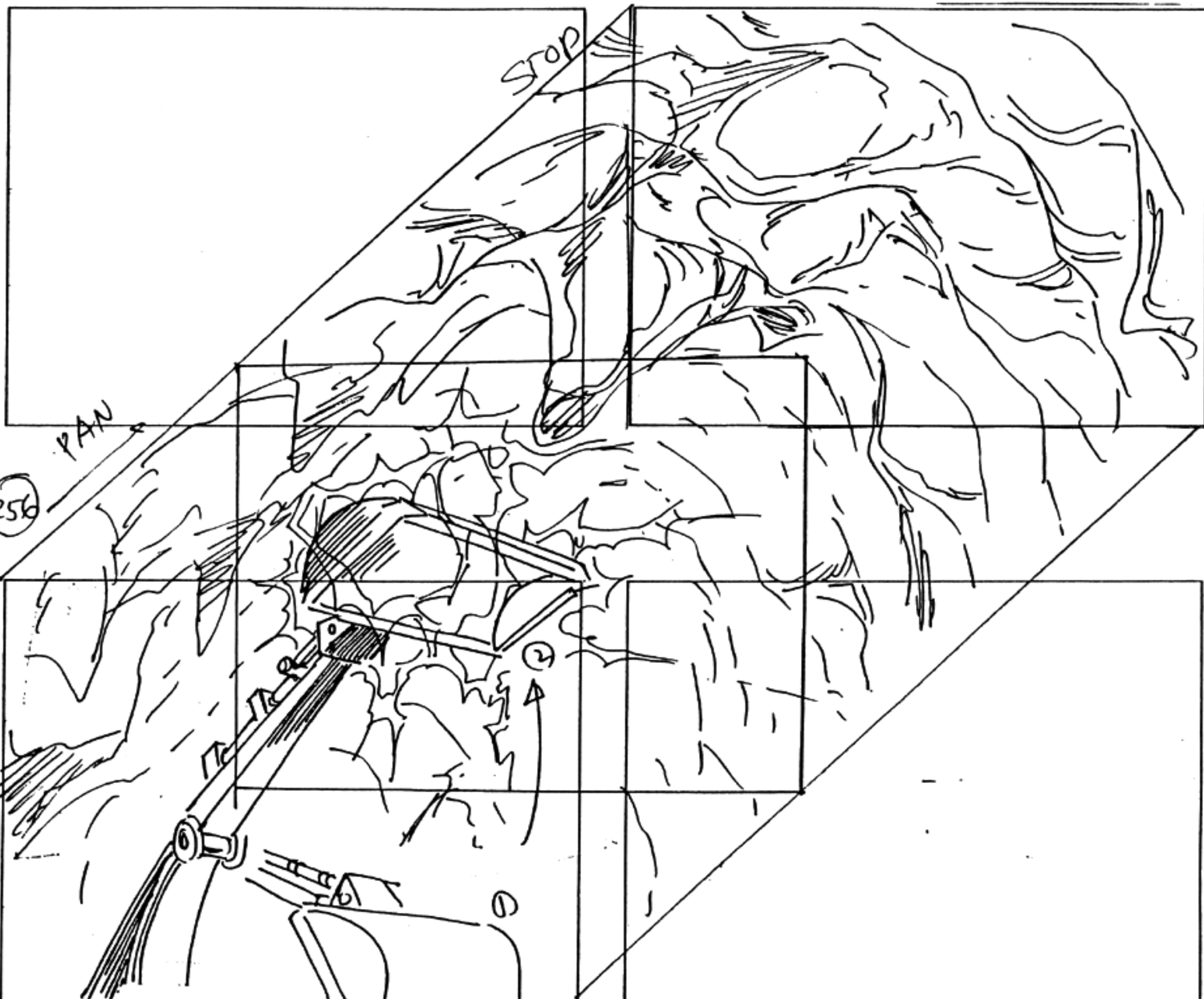
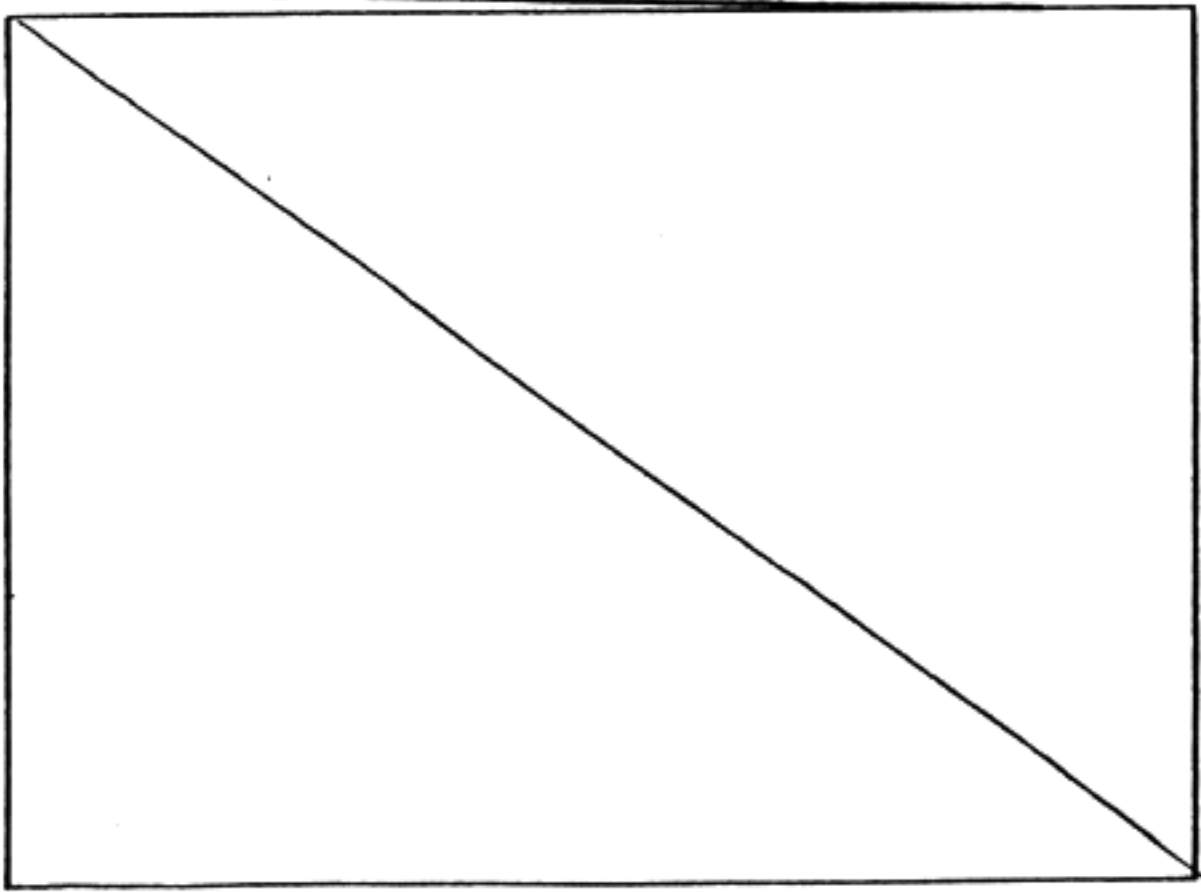

MICU. SCAVENGER HE REACHES TOWARD  
 THE CEILING. SCAVANGER: SCRAPPER--  
 I'M PICKING UP COMPUTER SIGNALS FROM ABOVE.

257

TRUCK OUT PAN →

STOP

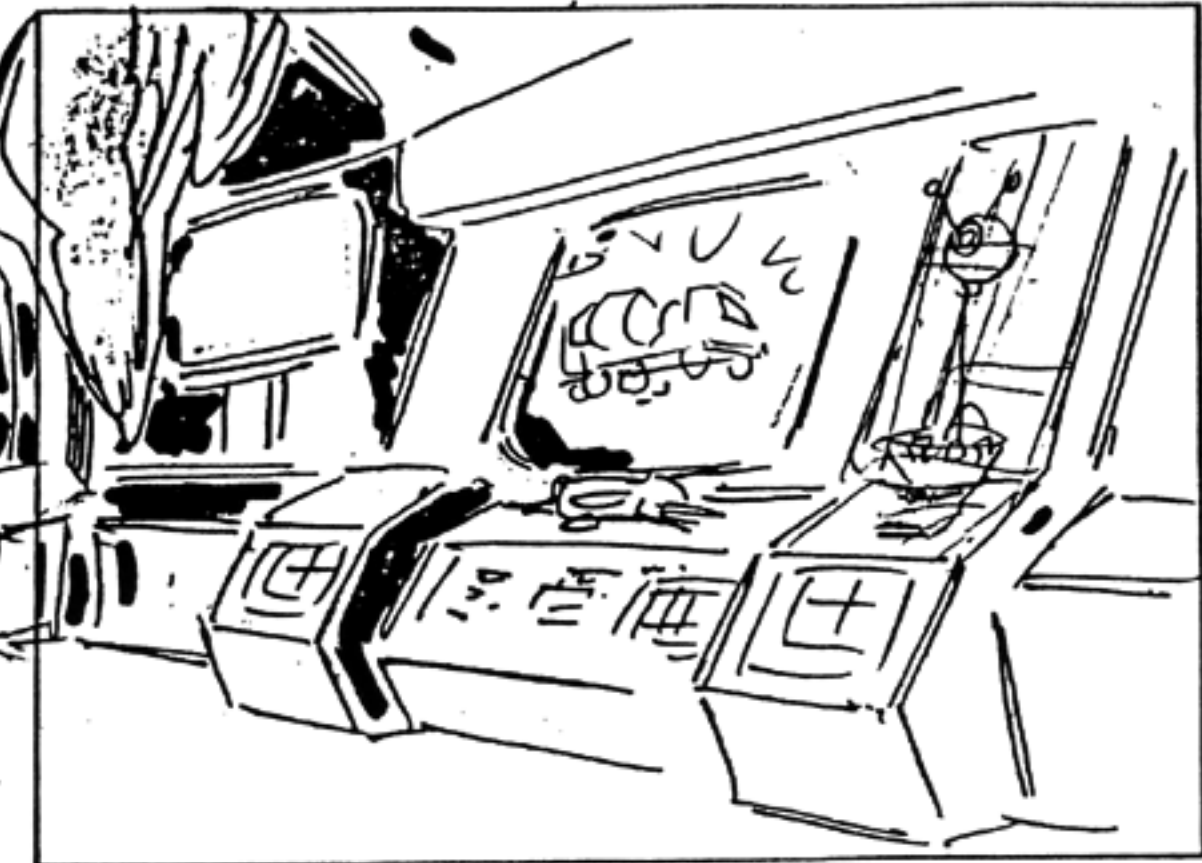
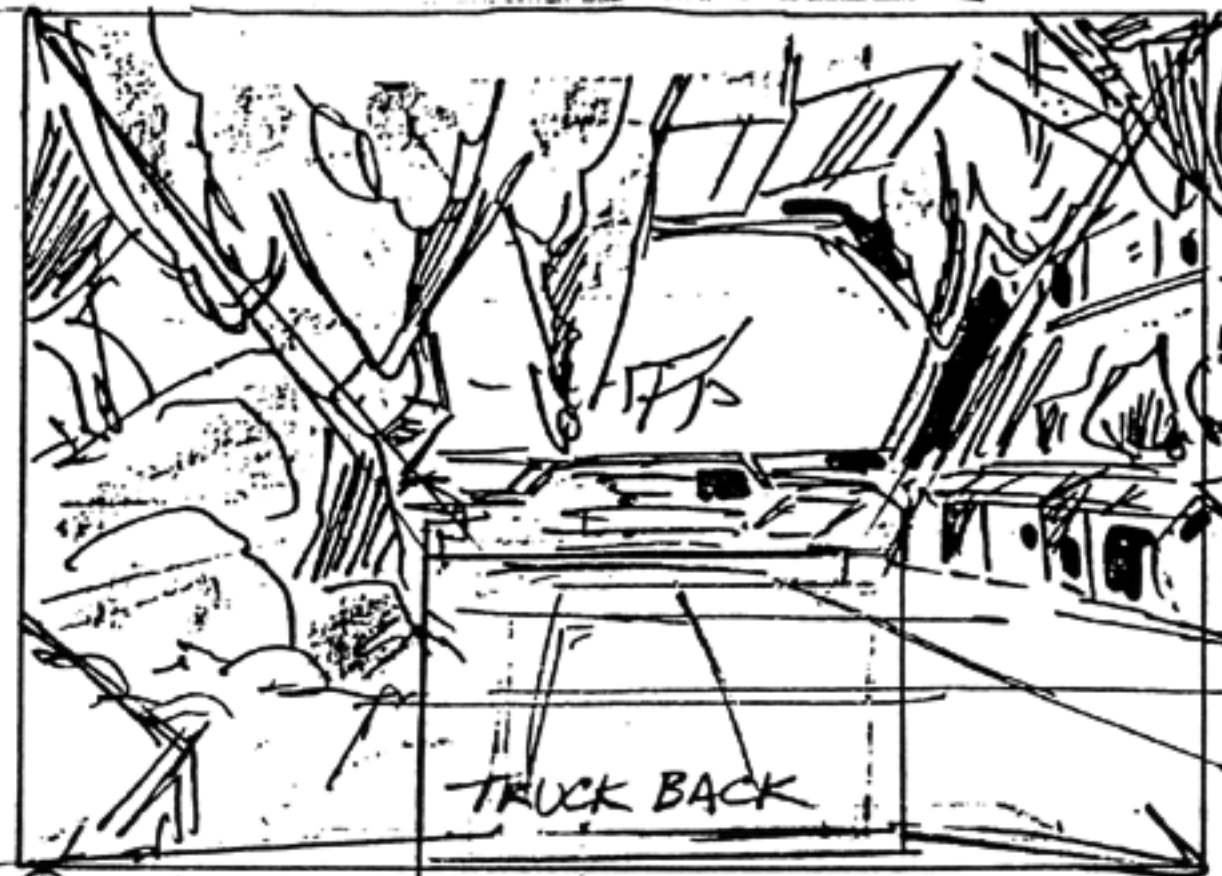
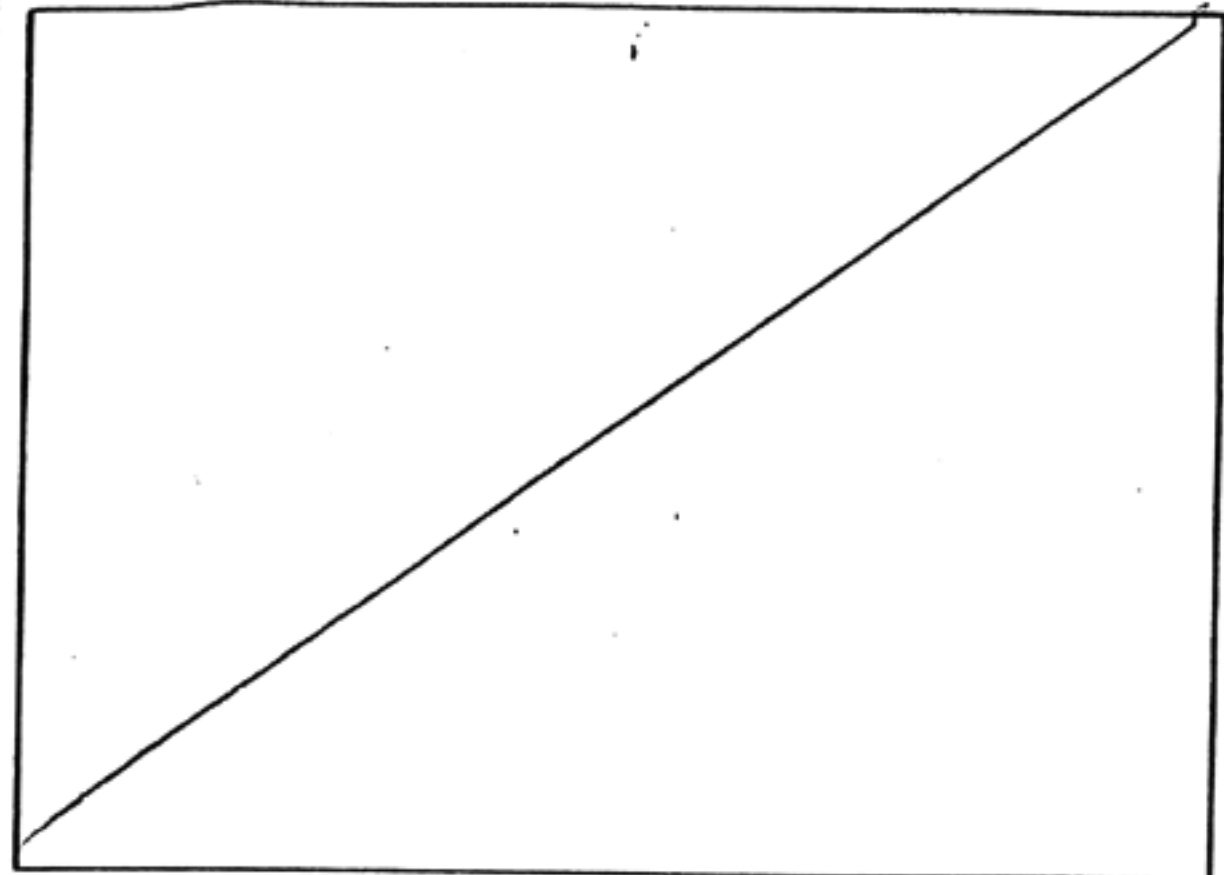

M.S. FLOOR AUTOBOT HEADQUARTERS. TRUCK BACK FROM FLOOR ABOVE CONSTRUCTIONS TO  
SEE EMPTY CONTROL ROOM. PAN TO TELETRAN I FLASHING WARNING SIGNALS & CONSTRUCTION  
SCAVENGER (VO) ... WE'RE DIRECTLY UNDER TELETRAN I IMAGES ON SCREEN  
CONT.

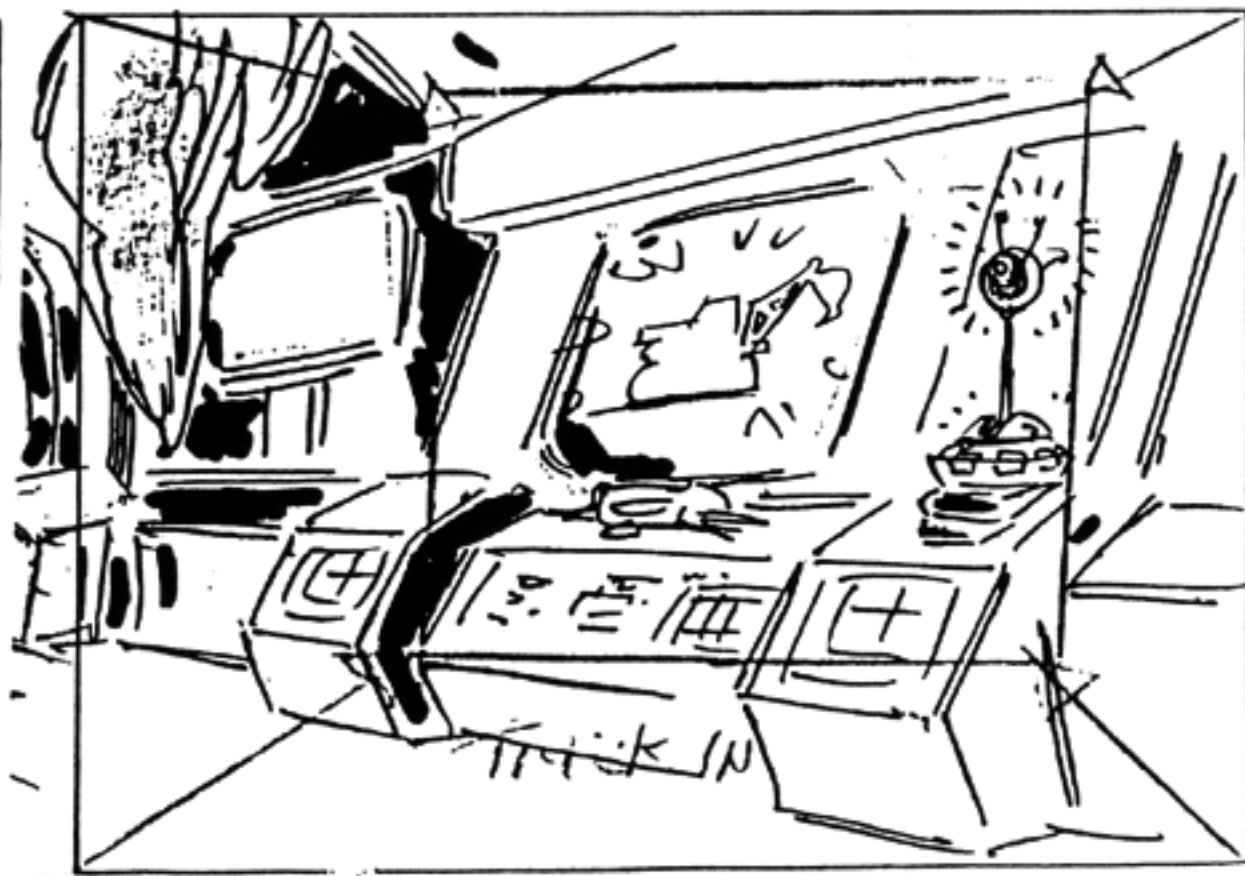
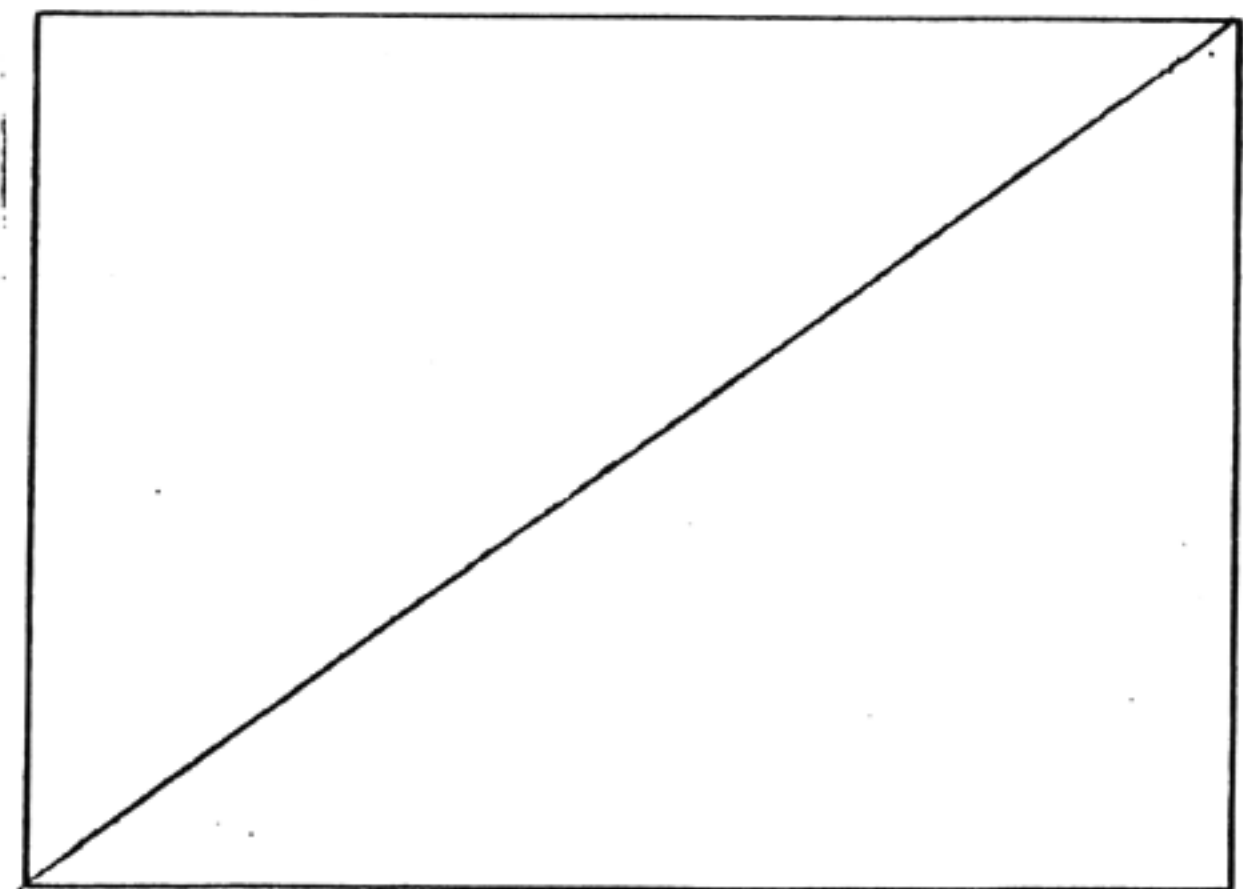
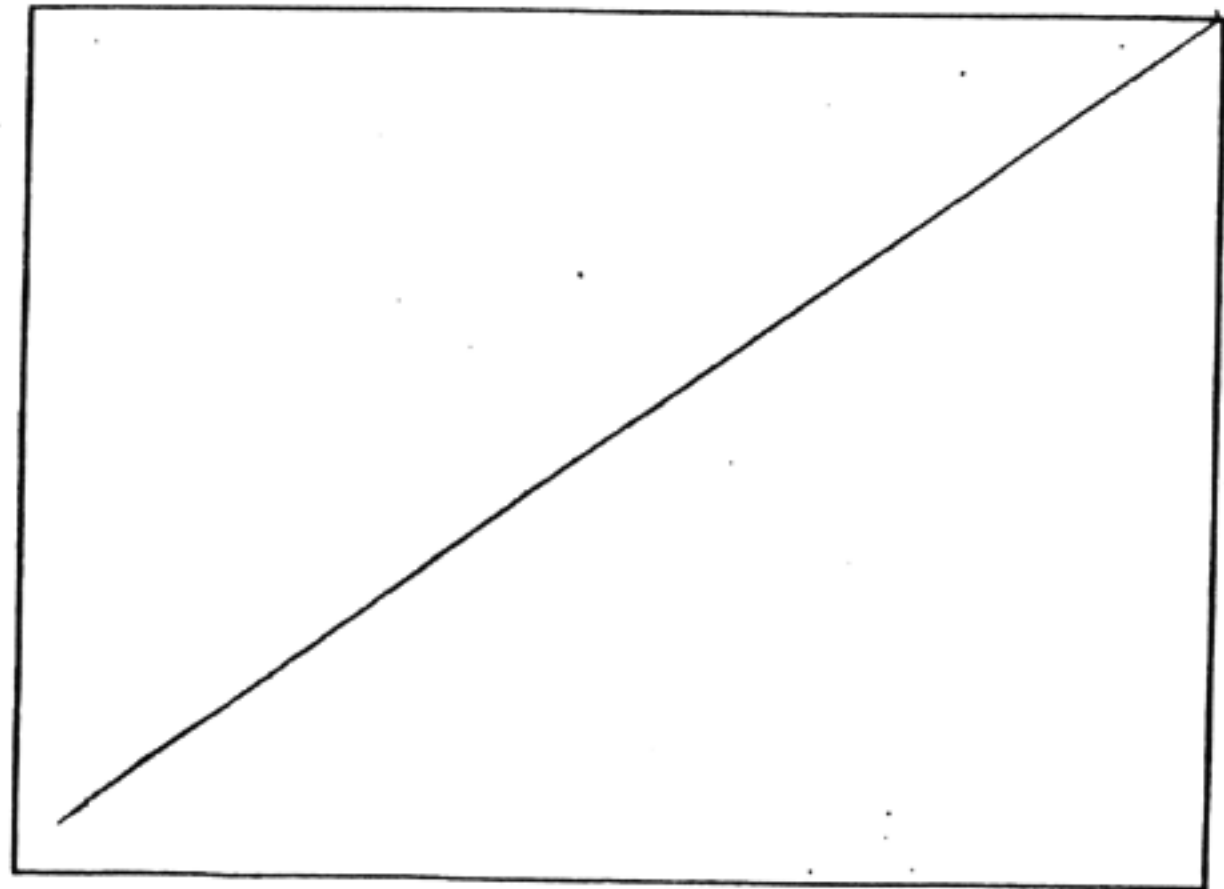

30° TRANSITION #3

TRUCK IN ON SCREEN AS IT FLASHES IMAGES OF  
BONECRUSHER, SCRAPPER, MIXMASTER, SCAVENGER, HOOK,  
AND LONGHAUL, REPEATEDLY TO EMPTY CONTROL ROOM

258

TRUCK OUT

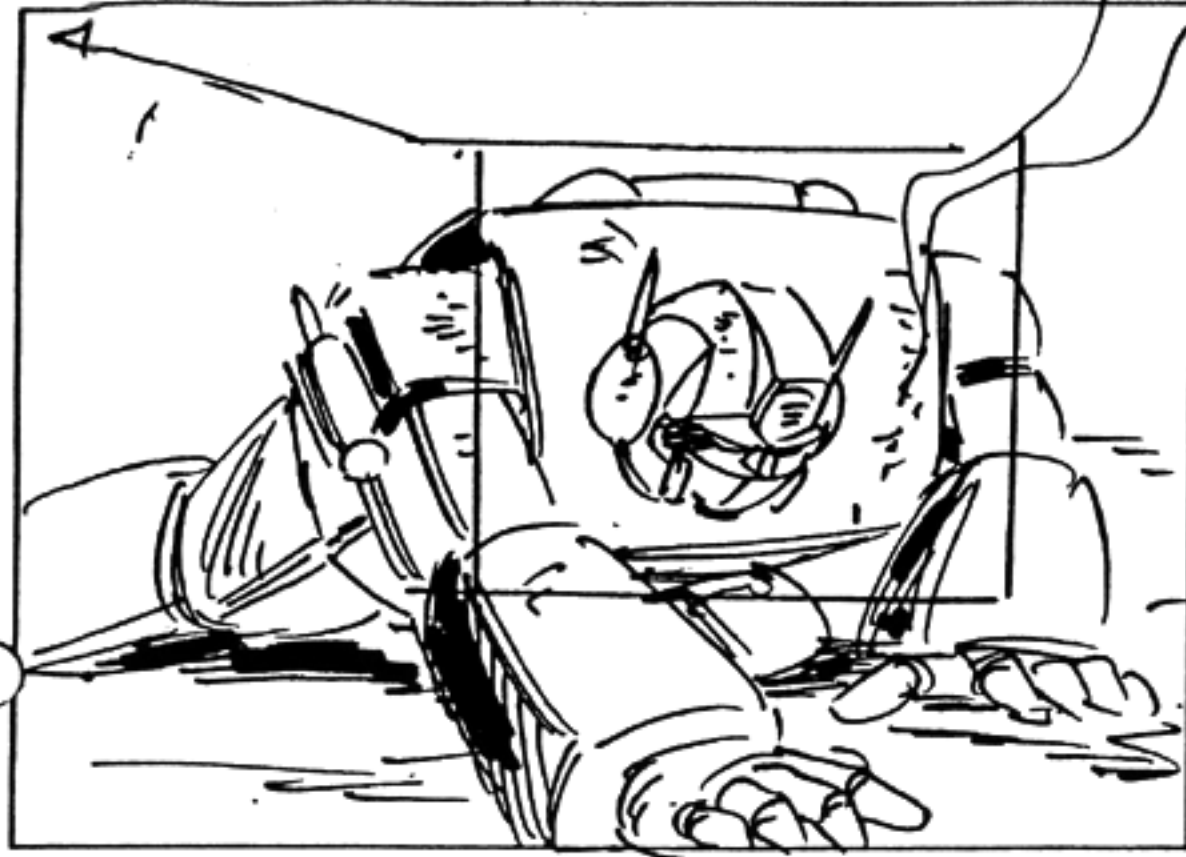

PRIME MAKES AN EFFORT TO GET UP  
HUMANS & AUTOBOTS (NO-LIB) "OPTIMUS PRIME"  
"GET UP, OPTIMUS! YOU CAN BEAT HIM, OPTIMUS!"

CONT.

260

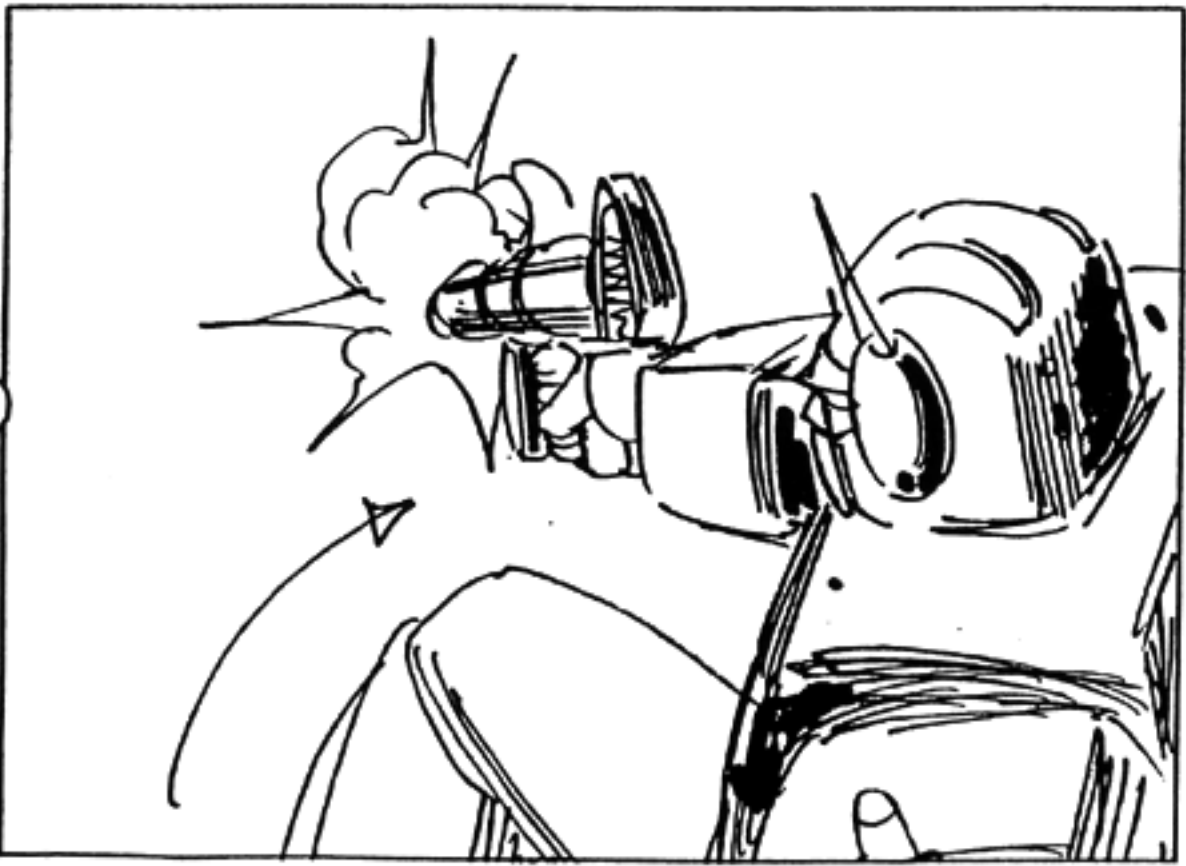

WITD SUDDENLY TURNS AND  
FIRES!

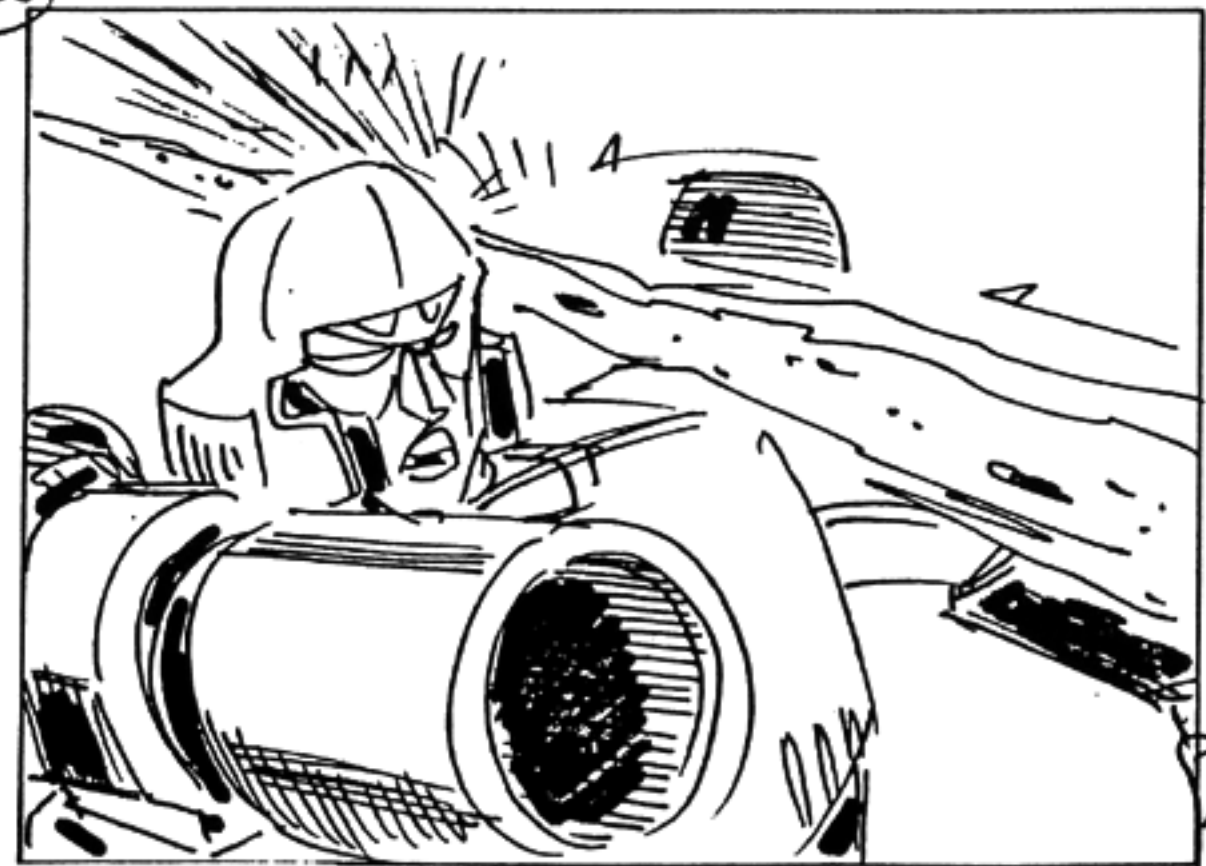
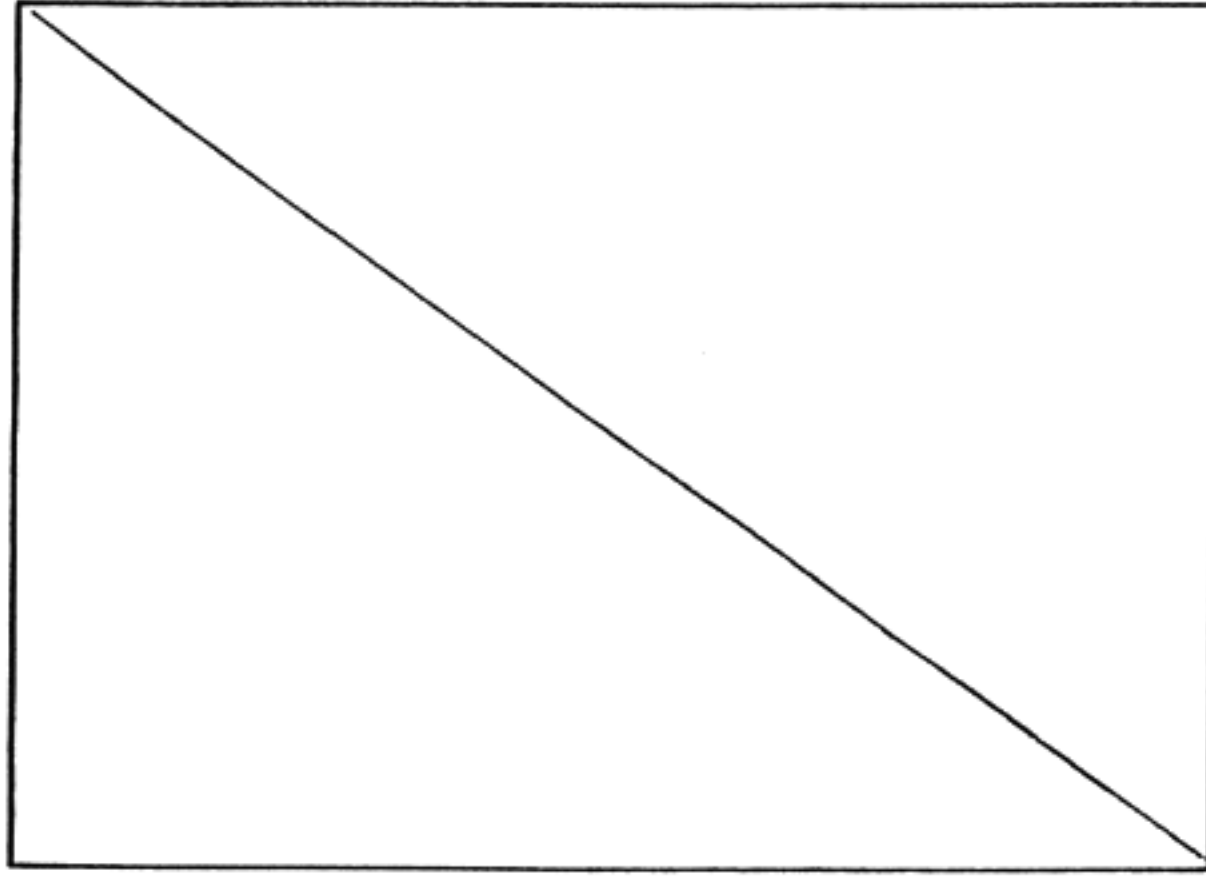

MIC.U. MEGATRON. PRIME'S BLAST  
CATCHES MEGATRON IN THE SIDE  
OF THE HEAD.

259

700-13

88

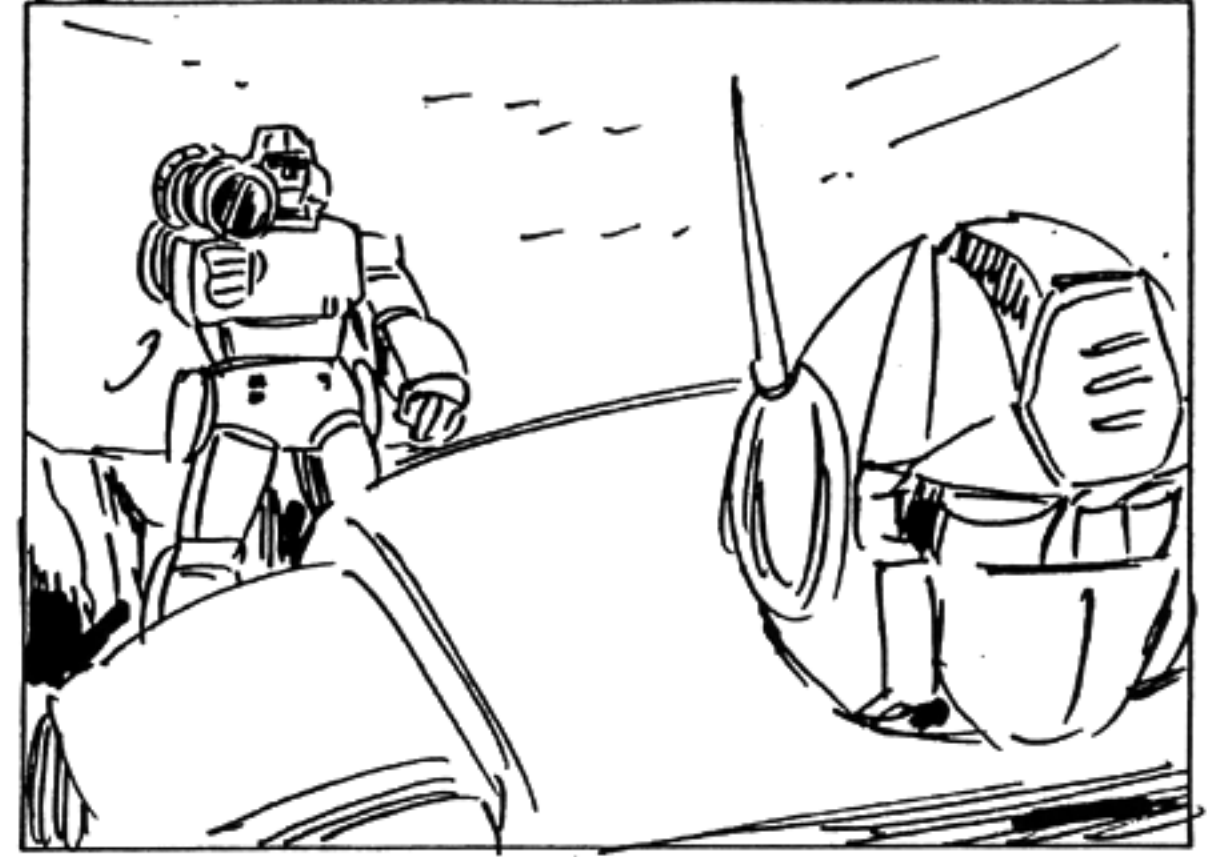

O.T.S. MEGATRON TAKES AIM AT  
PRIME

261

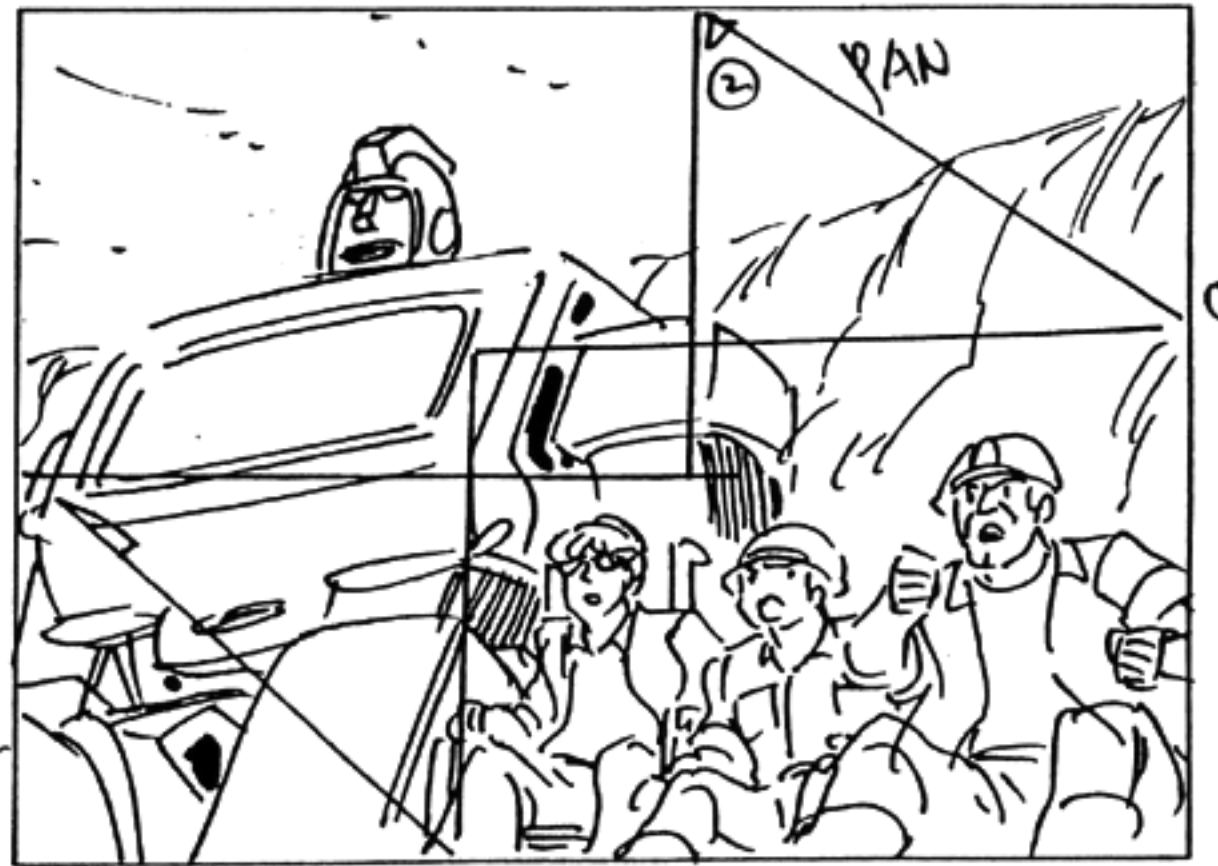

IRONHIDE, CHIP, SPIKE, SPARKPLUG.  
IRONHIDE: WAY TO GO, PRIME! YOU'RE  
NOT DOWN YET!

262

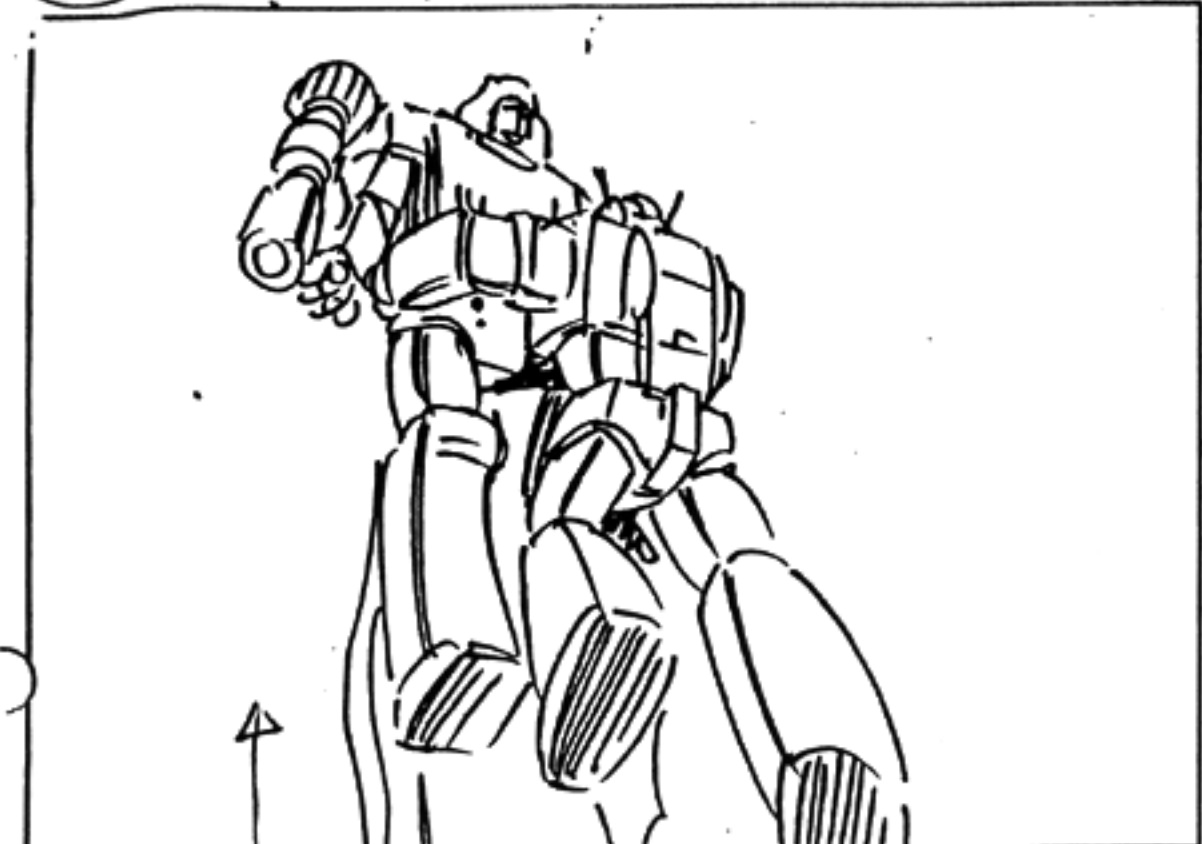

PAN up

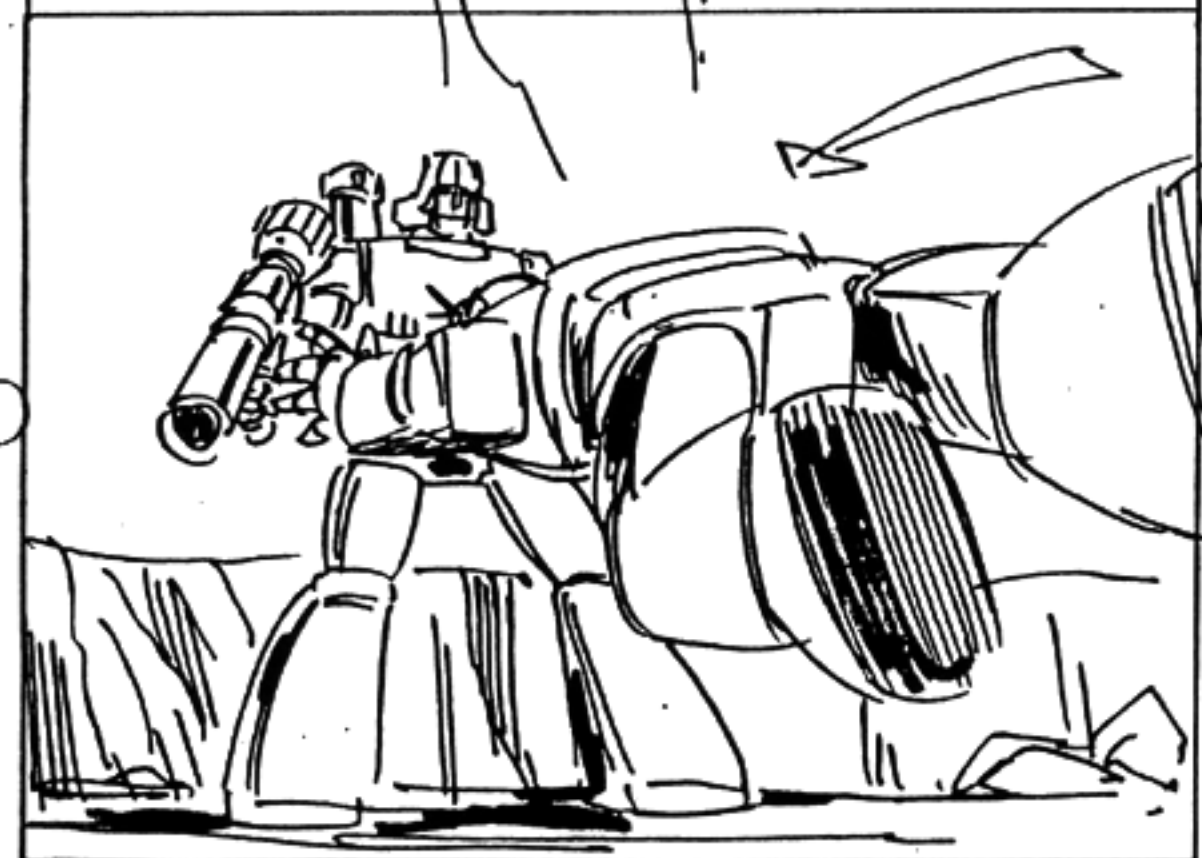

M.L.S. MEGATRON & PRIME, PRIME TACKLES MEGATRON WHO CARRIES THEM BOTH INTO THE AIR. MEGATRON: FOOLISH MOVE. I KNEW YOU WERE GOING TO DO THAT!

263

HOUND

WHEEL JACK

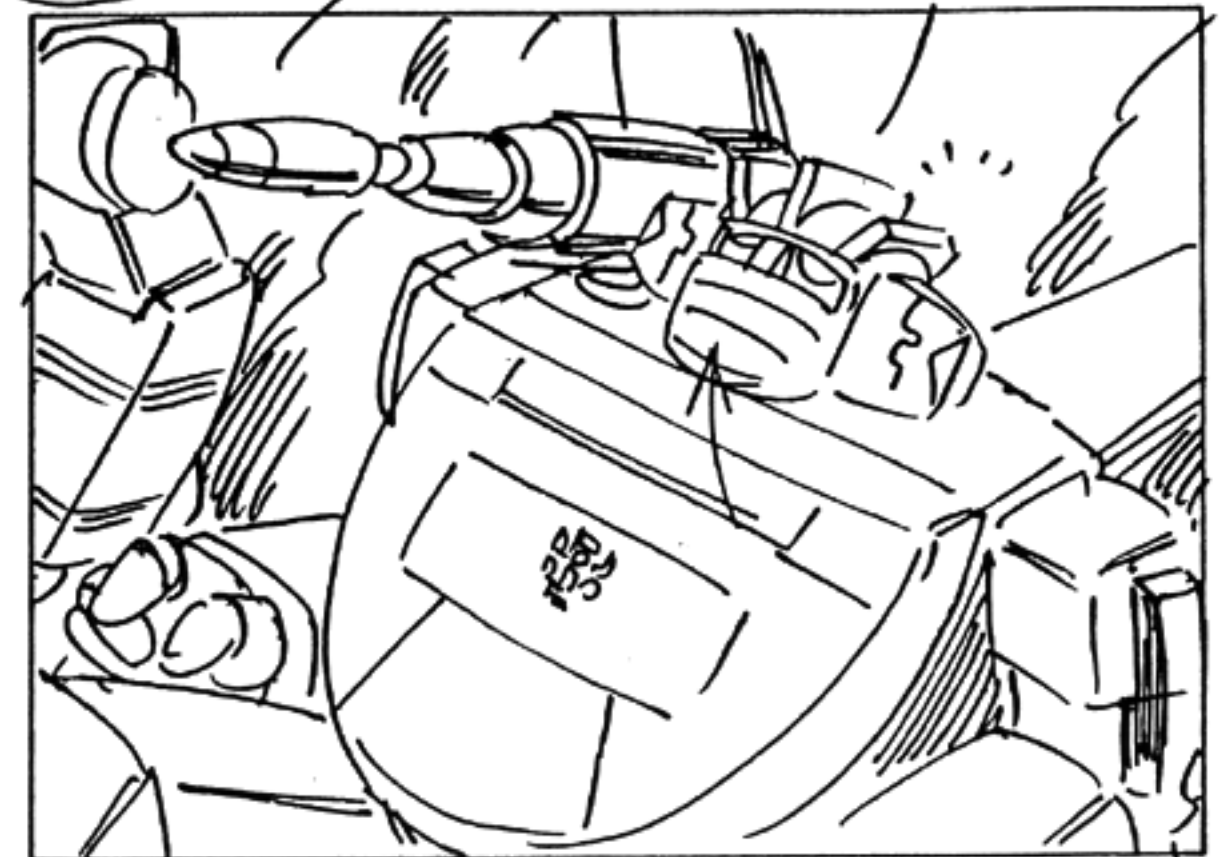

M.S. WHEELJACK, HE FOLLOWS THEM UP WITH HIS EYES. WHEELJACK (ASTONDED)

265 MEGATRON READ PRIME'S THOUGHTS JUST LIKE SOUNDWAVE.

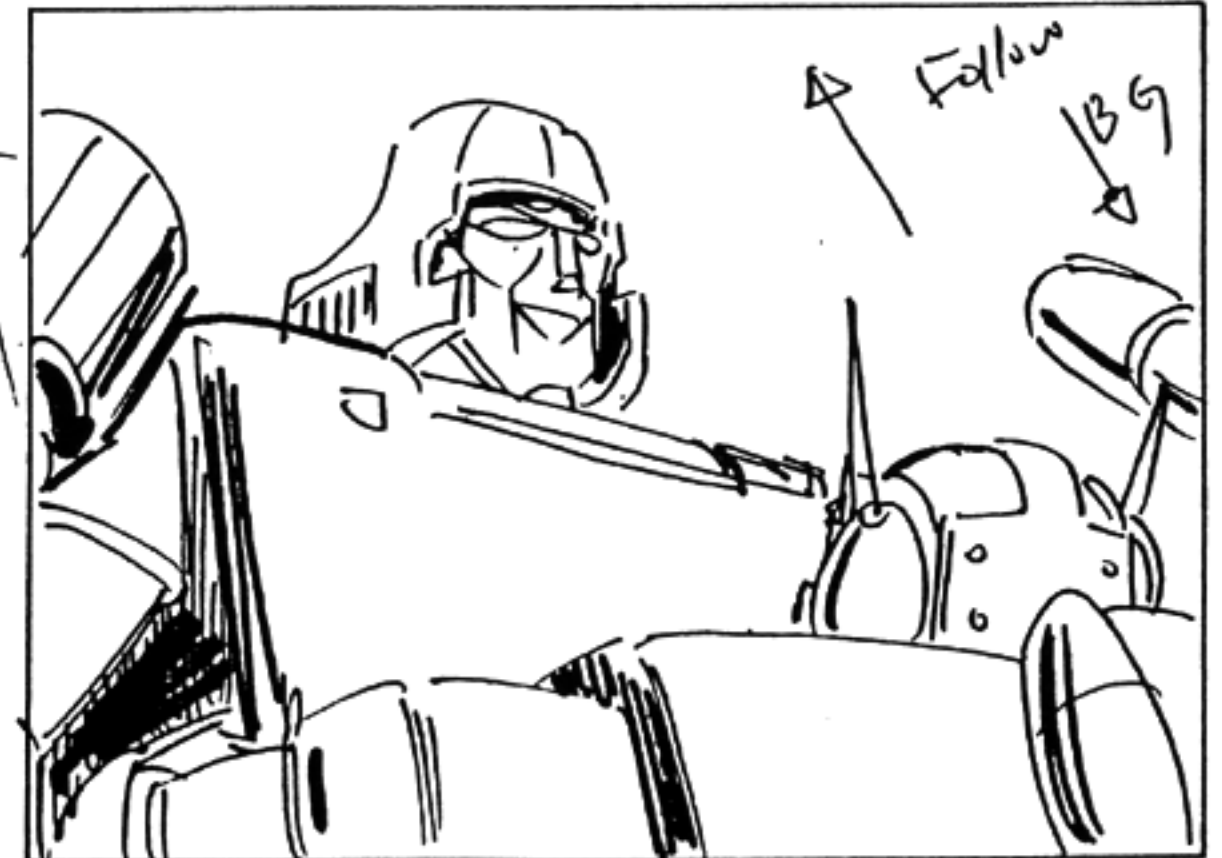

M.L.S. MEGATRON & PRIME, MEGATRON: YOU CANT BLAST WHAT YOU CANT SEE

264

700-13

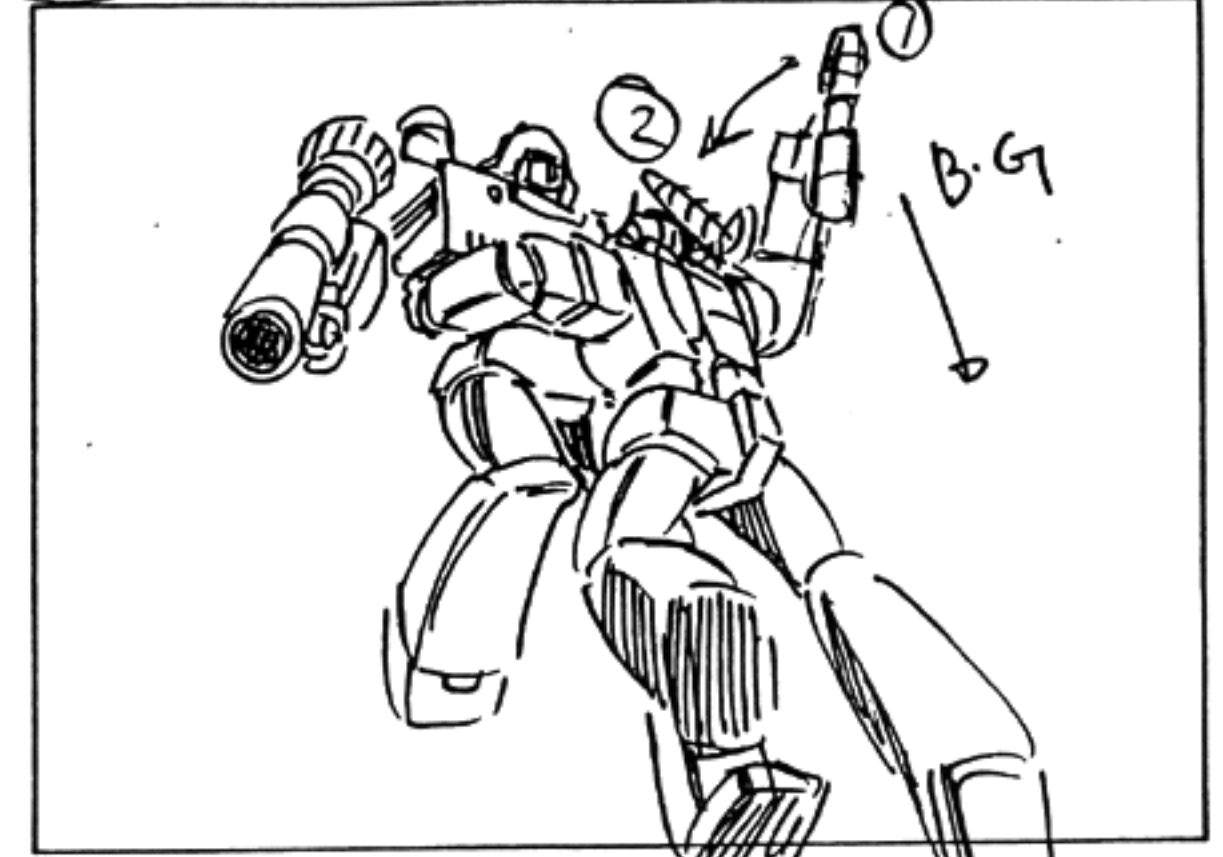

M.L.S. MEGATRON & PRIME. PRIME TAKES AIM.

CONT



AN EXPLOSION OF LIGHT EMANATES FROM MEGATRON!

START TRANSDRIVER

- PAN J ->

RATCHET STOP 1  
RATCHET

700-13  
SUNSPARKER

266

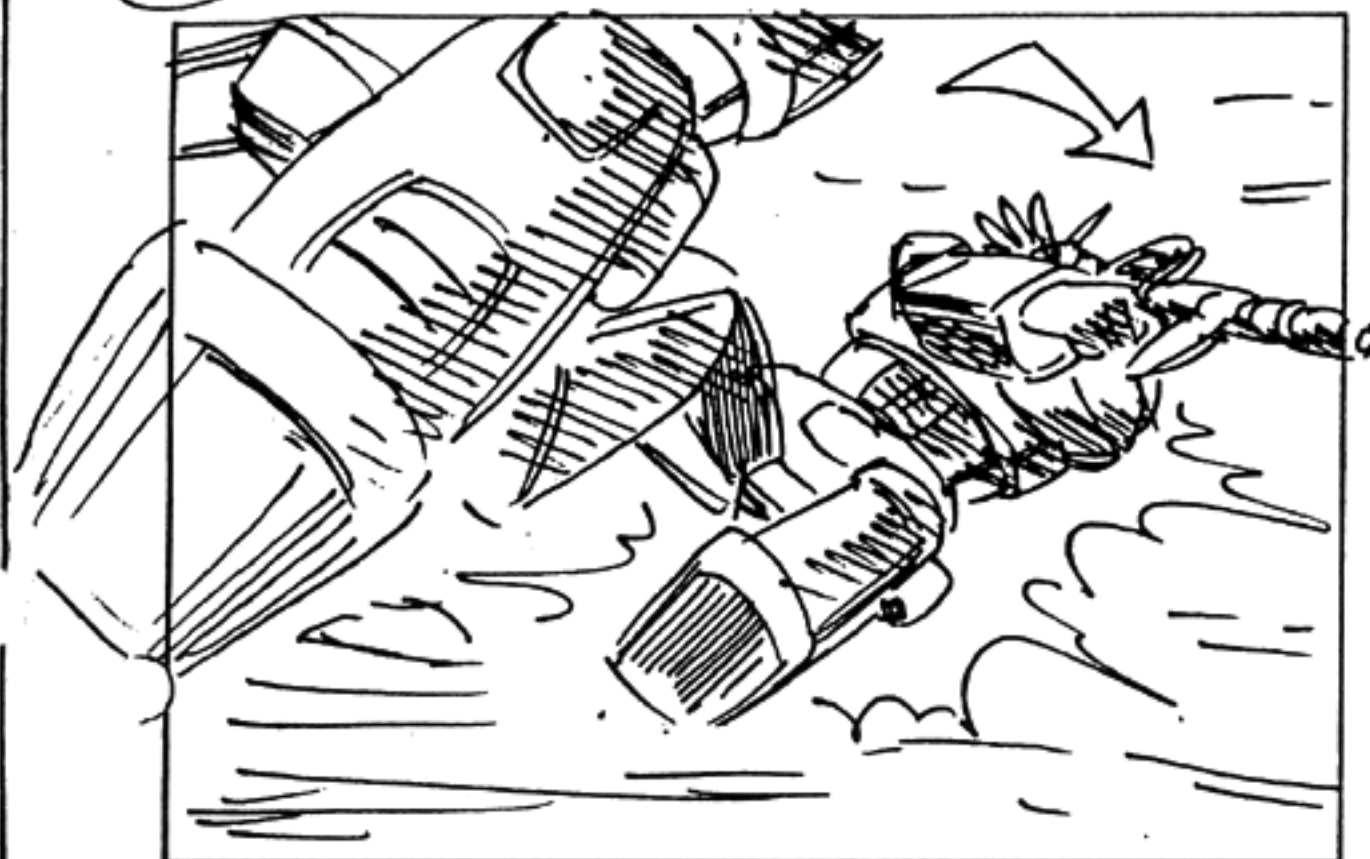

D.S. PRIME, HE FALLS BLINDED TO THE GROUND.

267

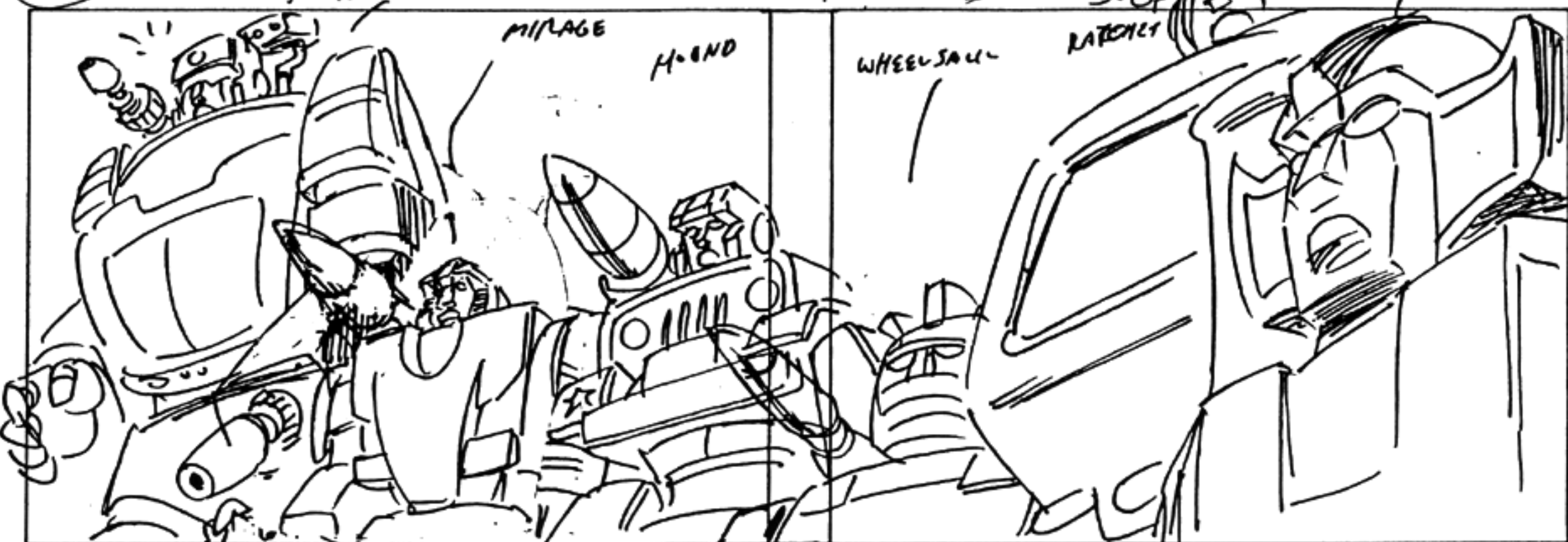

M.S. THE AUTOBOTS. STARTLED, DISBELIEVING.

268

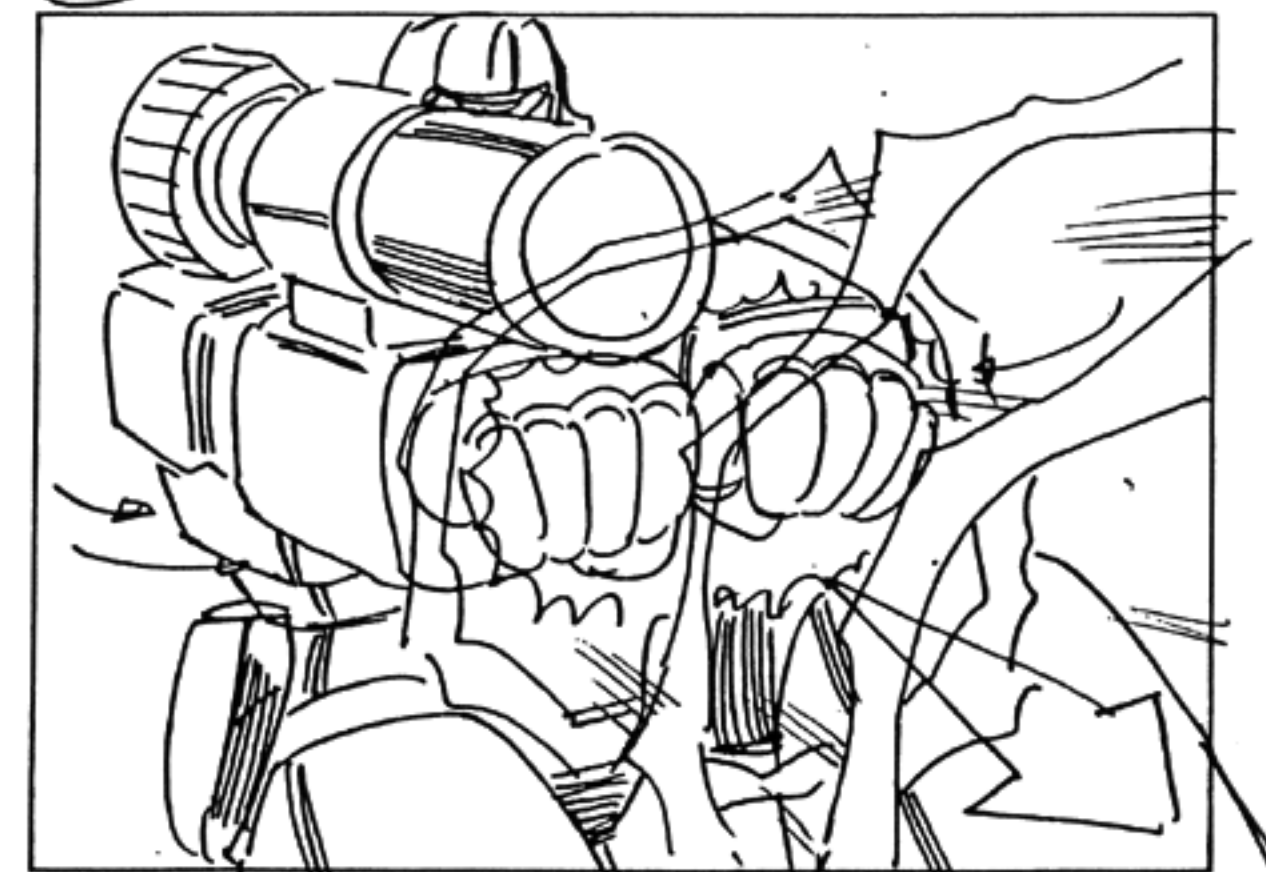

M.S. MEGATRON. HE SLAMS HIS FISTS TOGETHER!  
MEGATRON: 'NOR, WHAT YOU CAN'T HEAR!

269

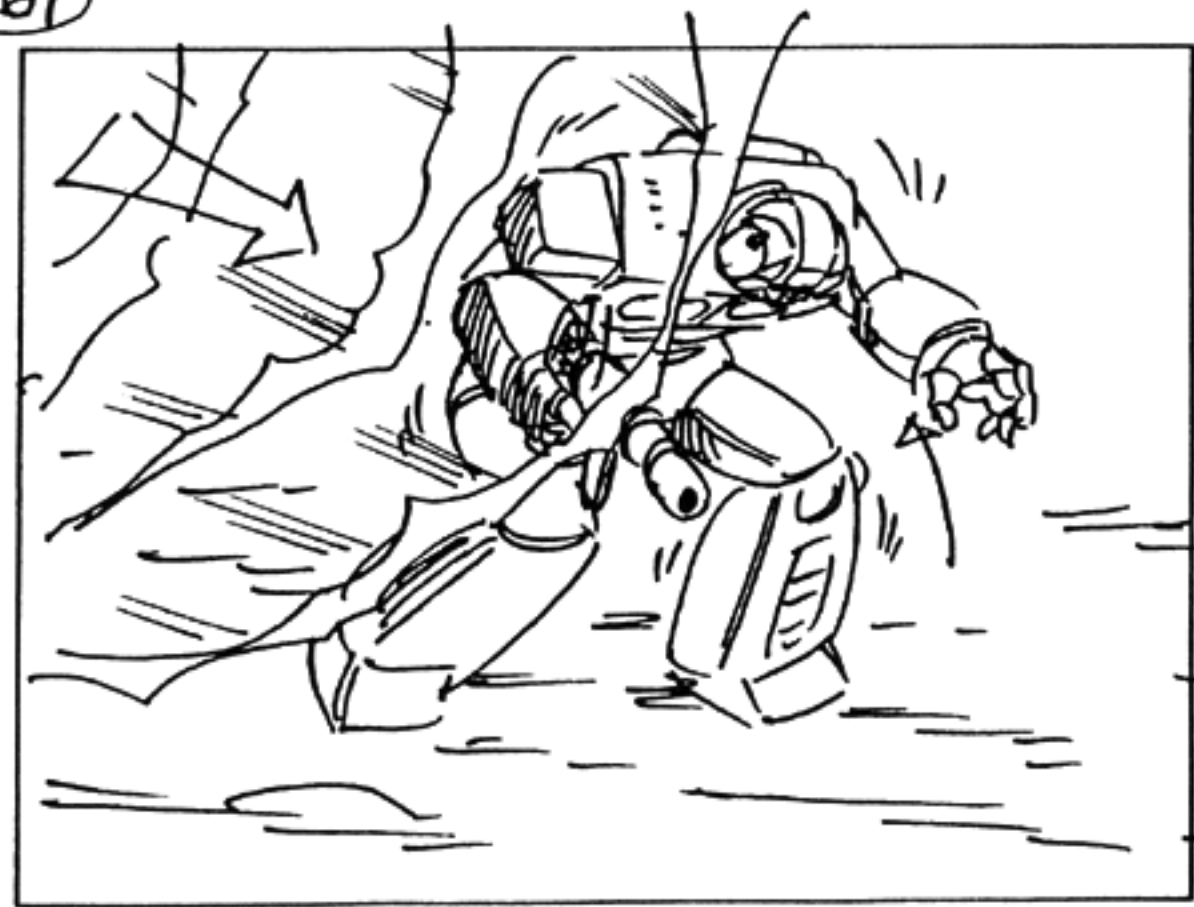

M.S. PRIME THE VISIBLE SONIC WAVES HIT HIM!

CONT

CONT

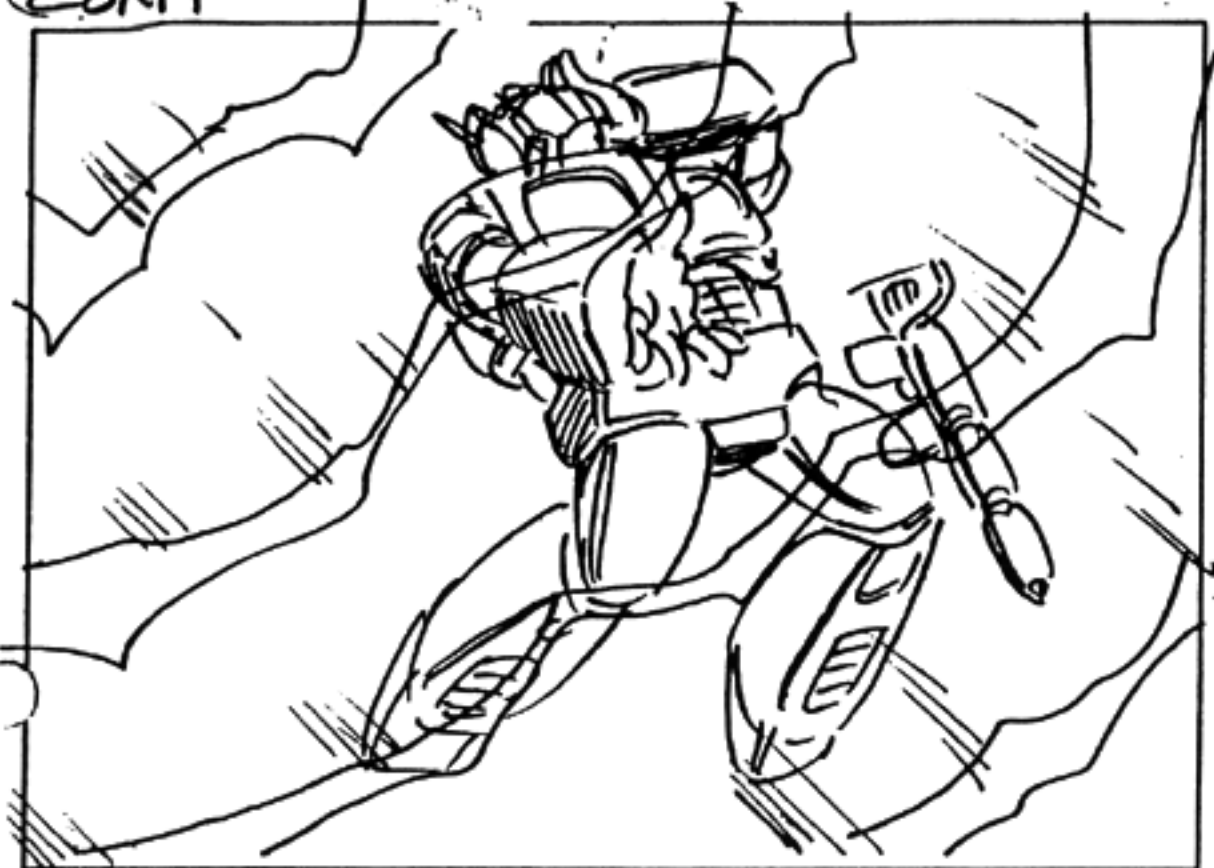

CONT



PRIME DROPS HIS WEAPON GRABS HIS HEAD AND SLUMPS HELPLESSLY TO HIS KNEES DEAFENED BY THE STUPENDOUS NOISE.

270

SKYWAMP

700-13

91



M.S. SKYWARP & STARSCREAM.

STARSCREAM REFLECTOR & THUNDERBOLT MUST BE PROUD. OR BATTER THEM DOWN. CITY RECTIFIERS MUST BE

271

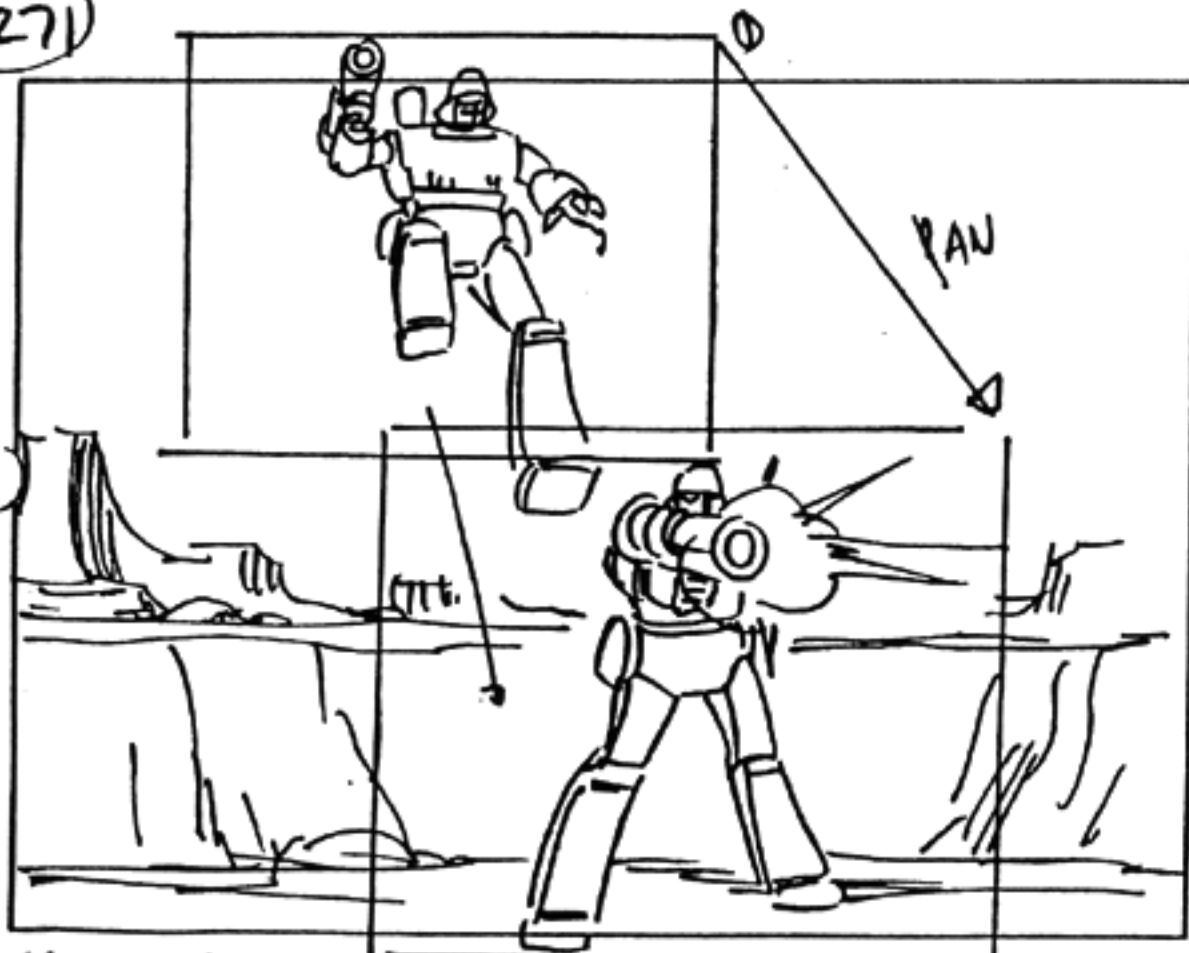

M.S. MEGATRON. HE LANDS. (2) TAKES AIM, AND FIRES A HEAT SEEKING MISSILE

272

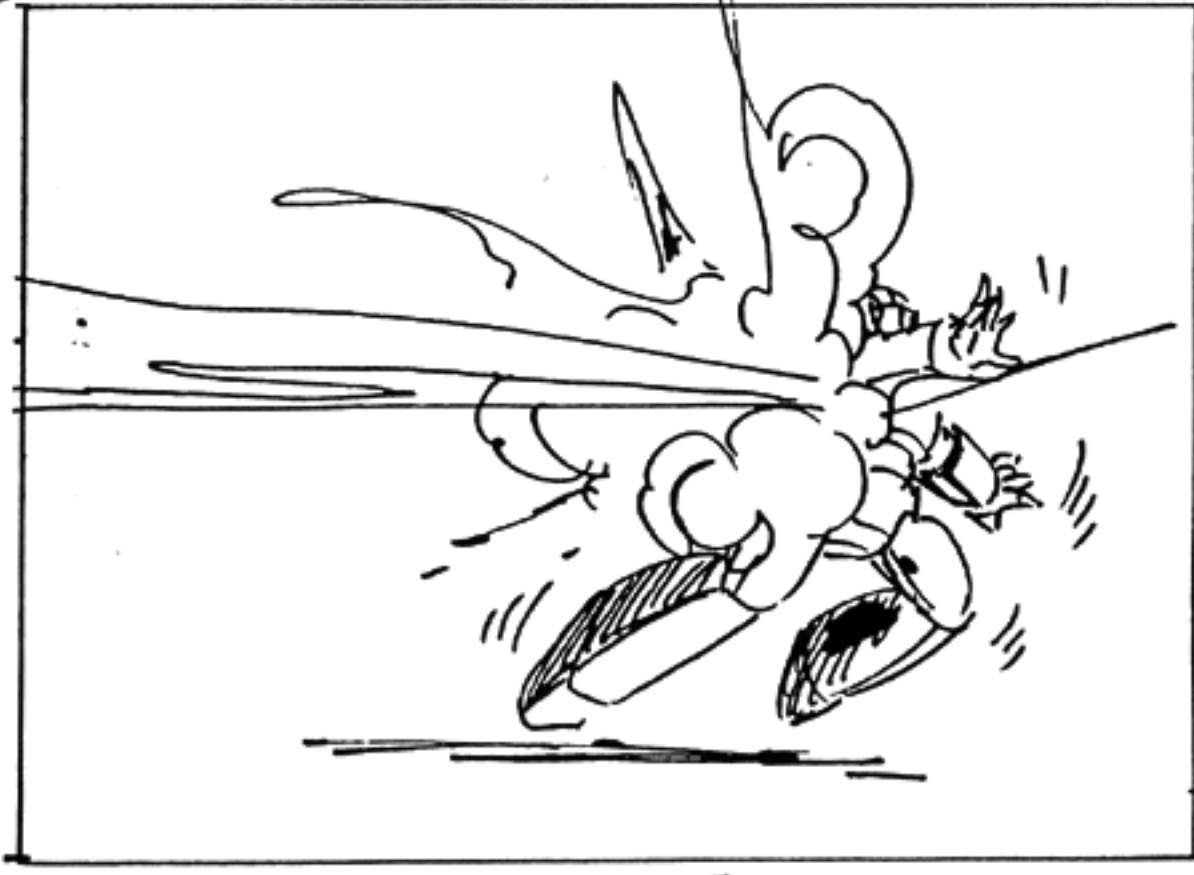
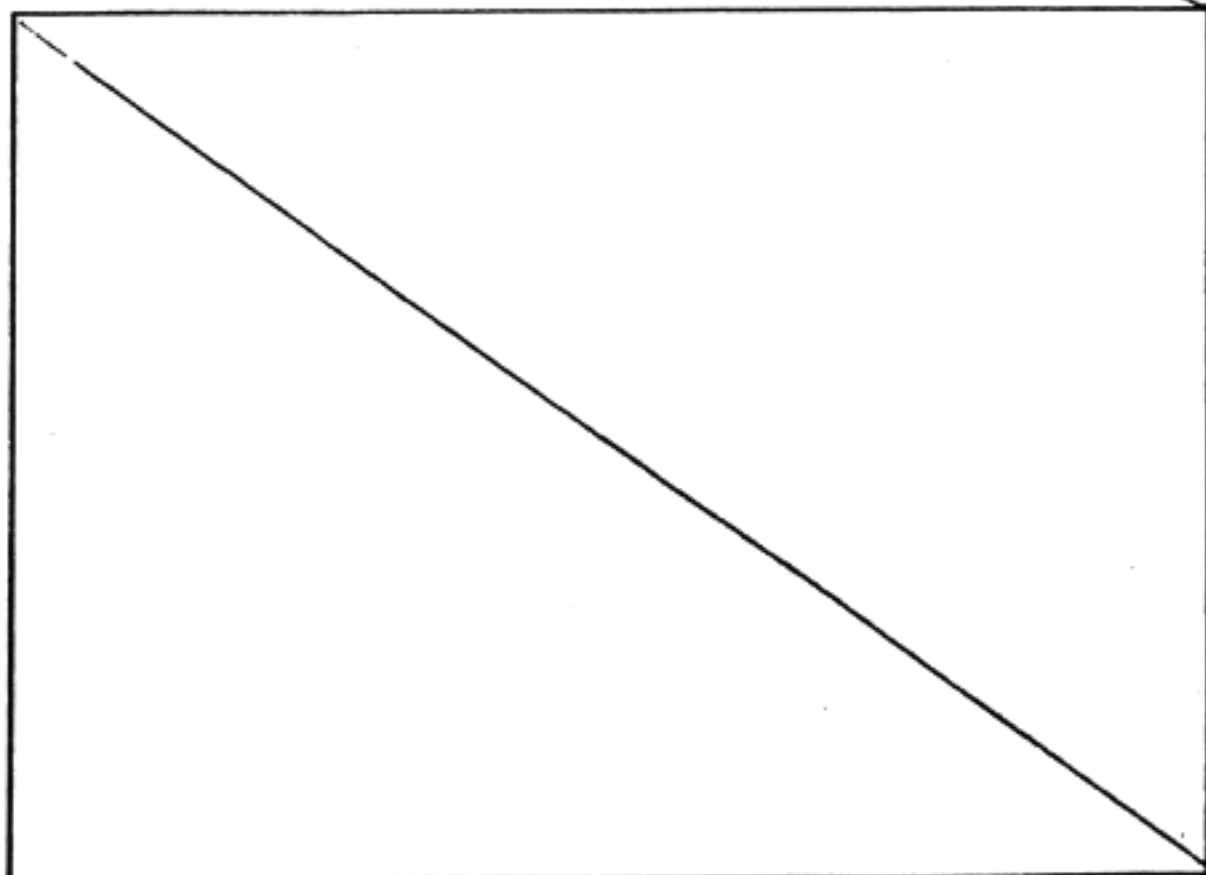

L.S. PRIME RISING SLOWLY TO HIS FEET STILL BADLY SHAKEN. MEGATRON'S MISSILE HITS HIM...

CONT

CONT: TRUCKING

70073

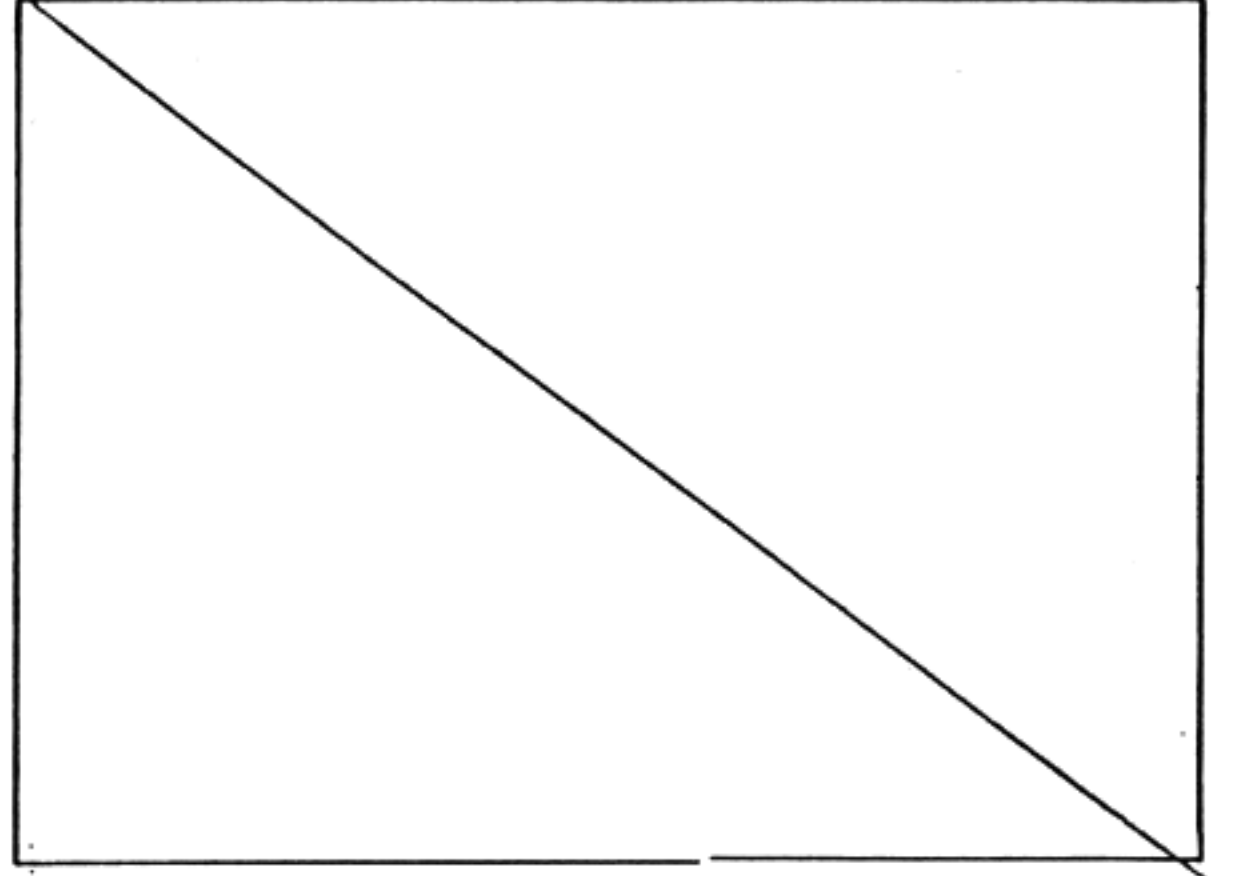
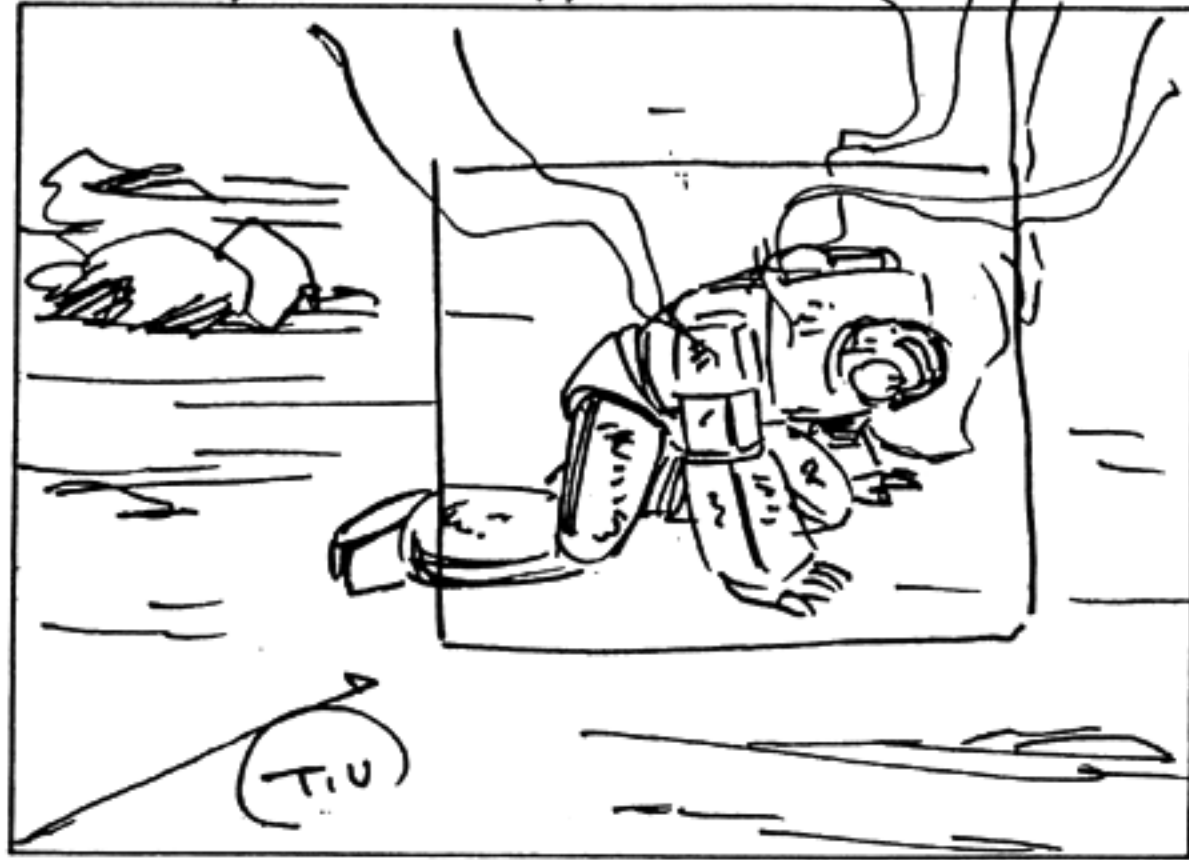
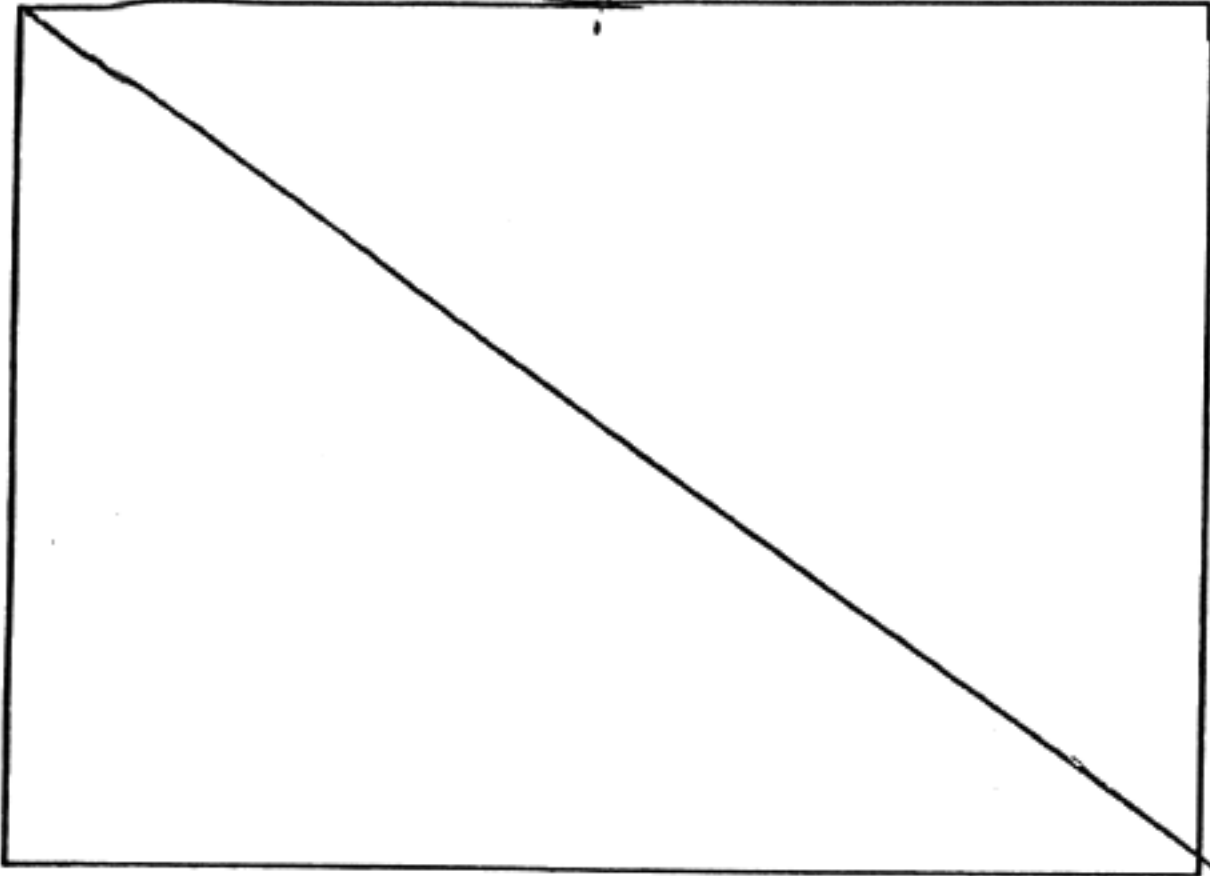

..THE BLAST KNOCKS PRIME BACK TO THE GROUND.

273

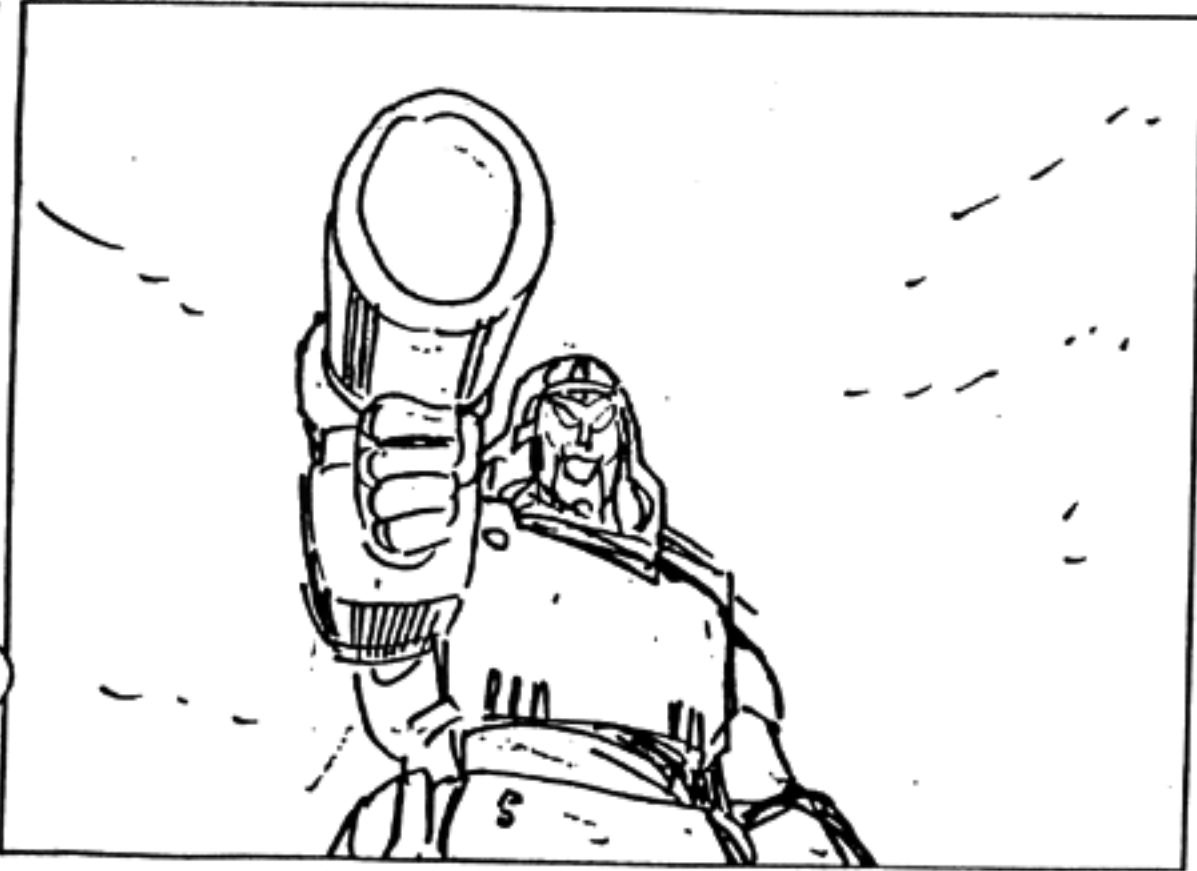

MIS. MEGATRON HE TAKES AIM AT PRIME MEGATRON: YOU WERE GOOD, OPTIMUS PRIME - BUT NOT GOOD ENOUGH TO FIGHT MEGATRON!

274 START PAN →



MIS. THE AUTOBOTS & HUMANS STAND TO THEIR FEET...



.. THEY REACT IN SHOCK & DISBELIEF!

275

START

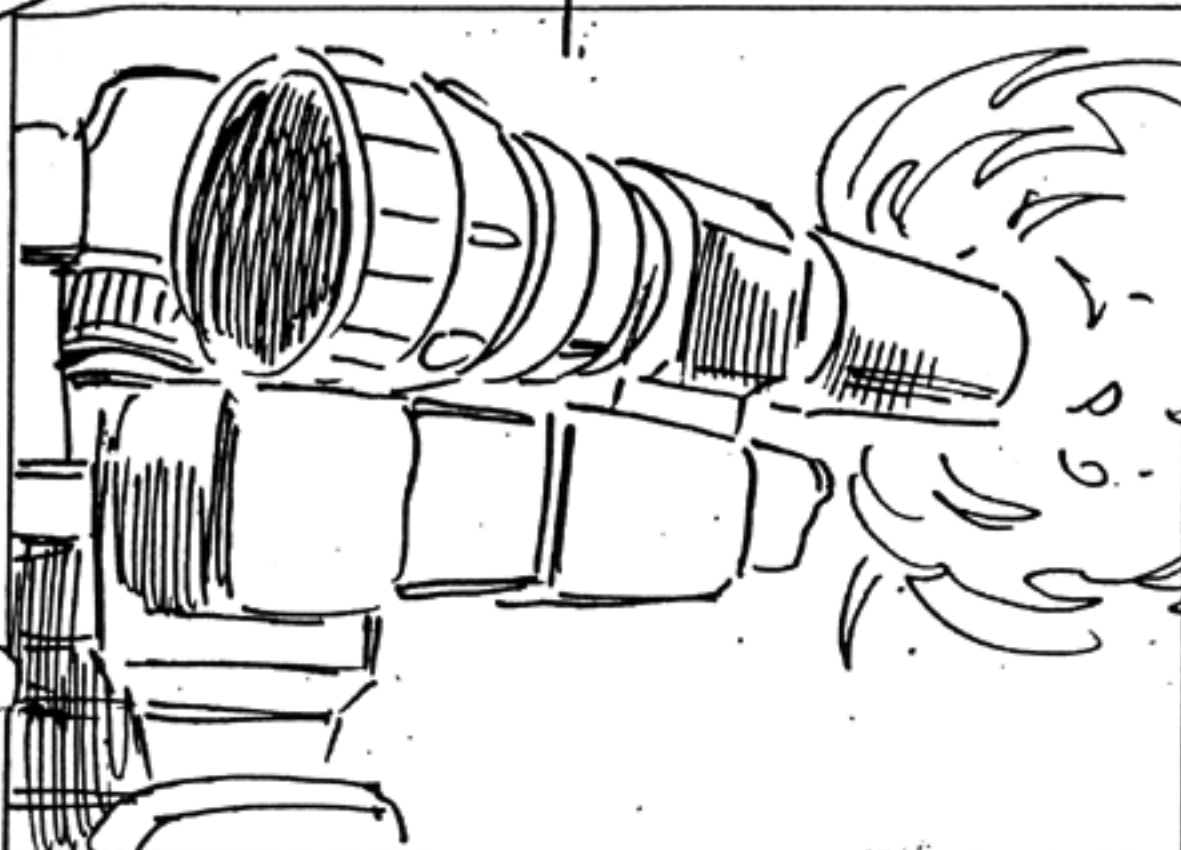

PAN BG &

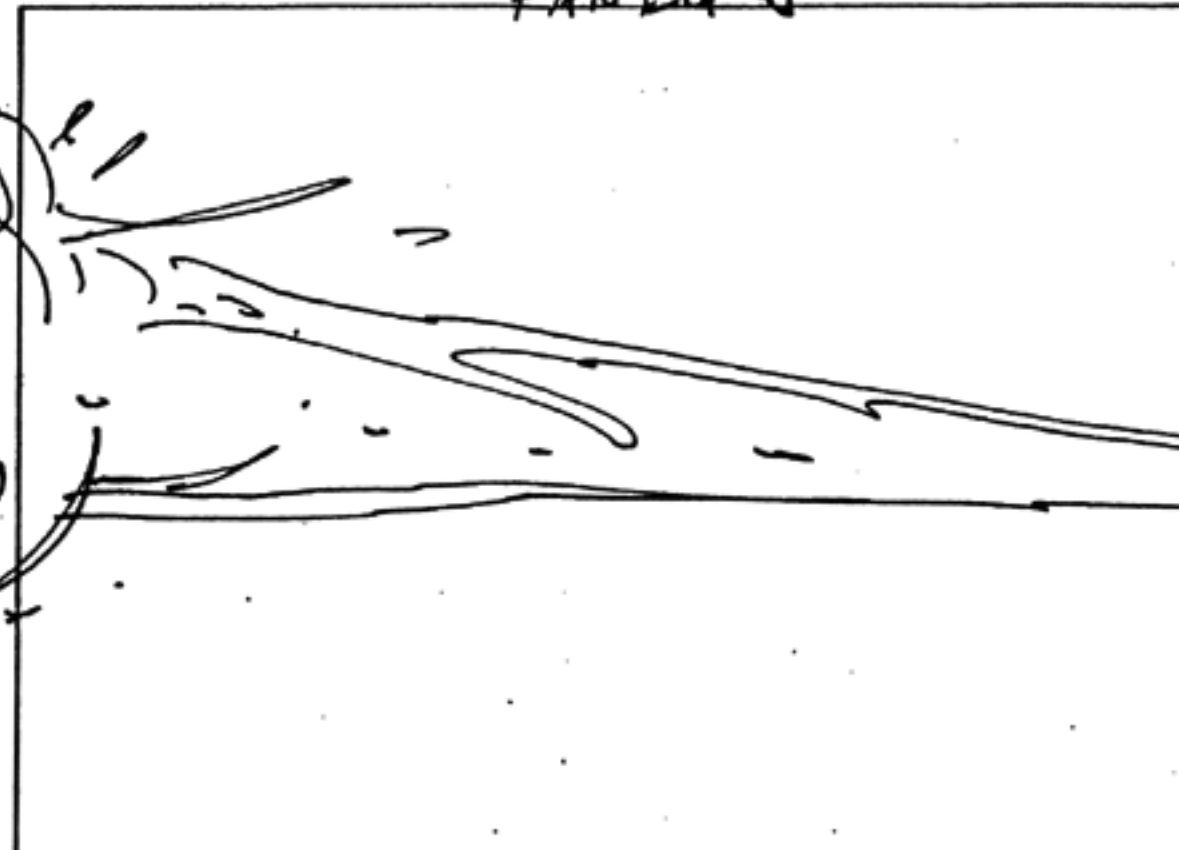

STEP 100-13,

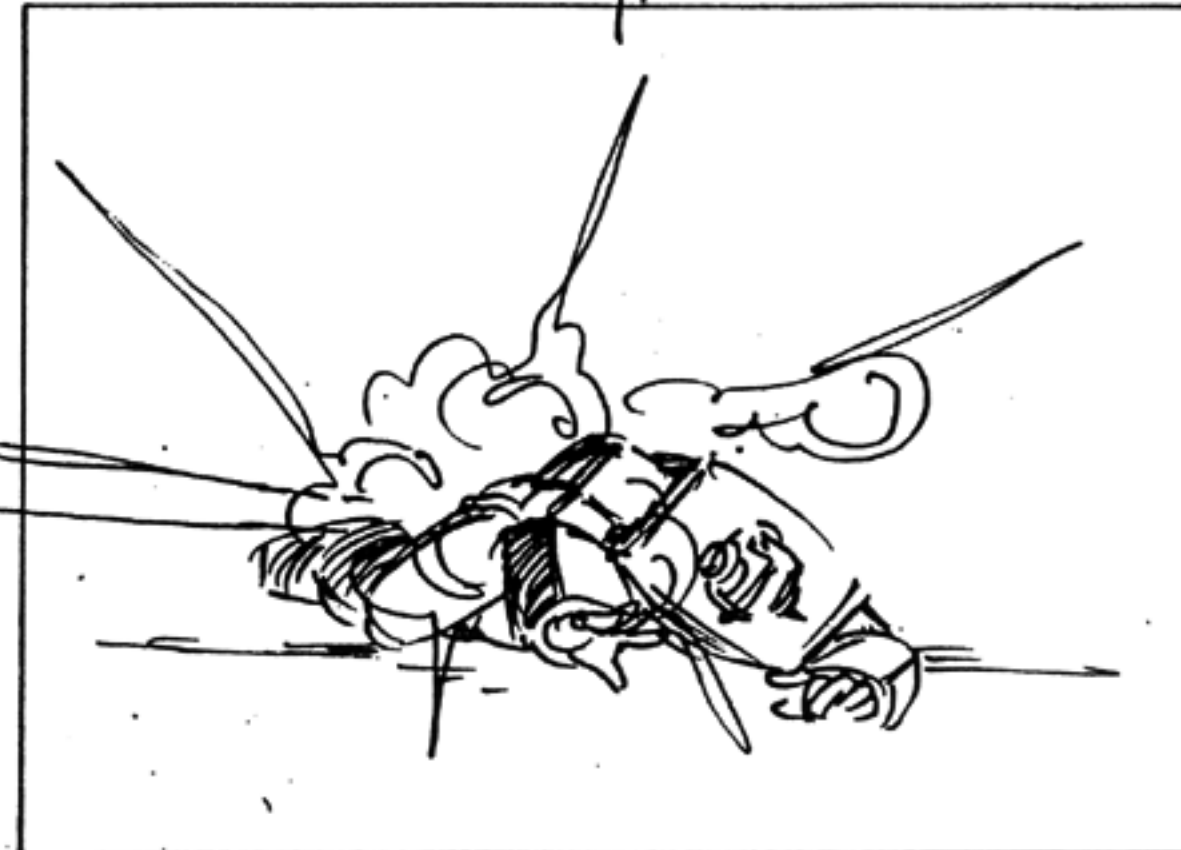

O.T.S. M.C.U. MEGATRON, AIMING AT O.S. PRIME!

MEGATRON FIRES HIS COUP-DE-GRAS AT THE BADLY INJURED PRIME

276

MEGATRON! AND SO THE BATTLE ENDS!

CONT

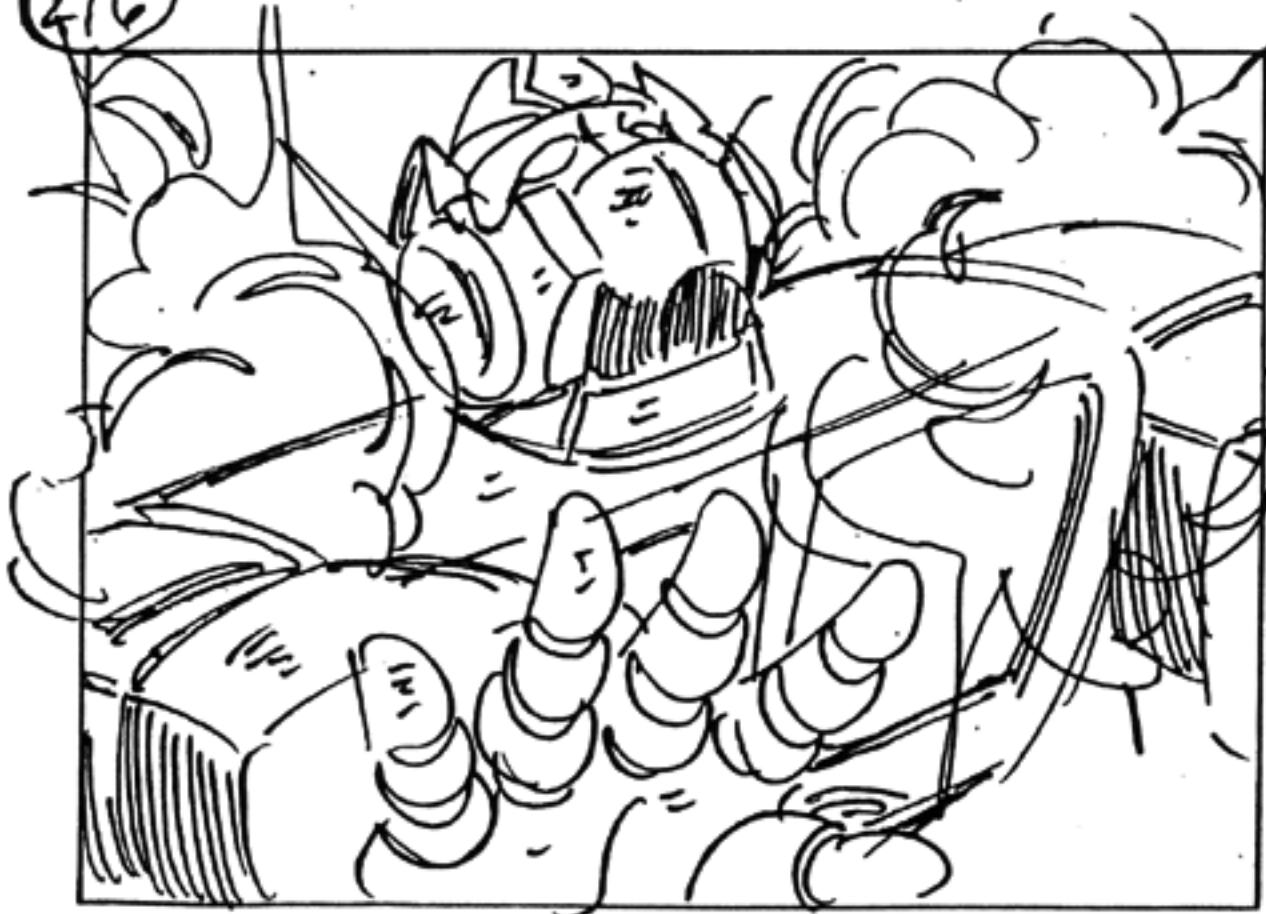

CONT

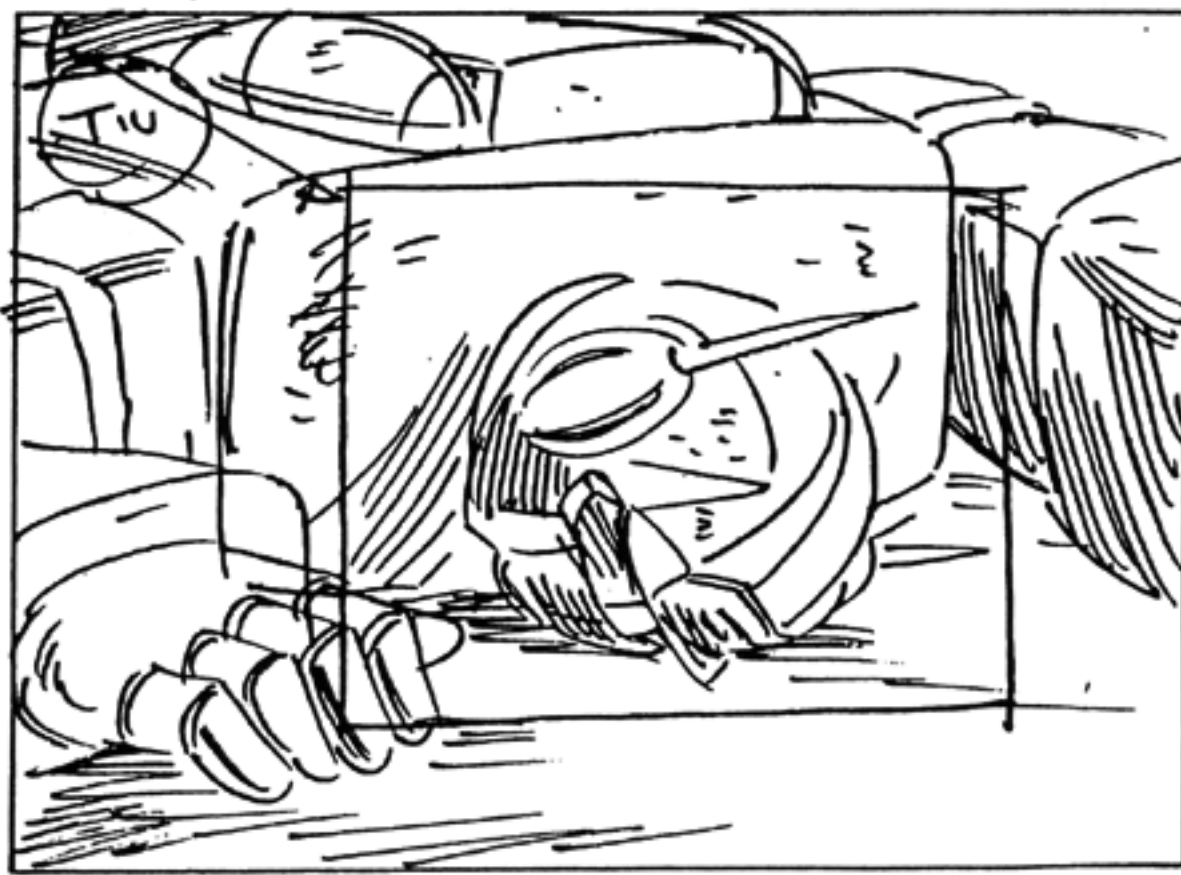

C.I.U. PRIME, HE IS STRUCK BY THE BLAST! HE REACTS AS IF A GREAT PAIN IS SURGING THROUGH HIM. THEN THE

BLAST ENDS... HIS EYES CLOSE... AND HE CRASHES MOTIONLESS

AGAINST THE GROUND! END OF ACT II